



FIRE

WEATHER

AGRICULTURE HANDBOOK 360

U.S. Department of Agriculture • Forest Service

NFES 1174

PMS 425-1

FIRE WEATHER

AGRICULTURE HANDBOOK 360

U.S. Department of Agriculture – Forest Service

FIRE WEATHER ...

A GUIDE FOR APPLICATION OF METEOROLOGICAL
INFORMATION TO FOREST FIRE CONTROL OPERATIONS

Mark J. Schroeder

Weather Bureau, Environmental Science Services Administration
U.S. Department of Commerce

and

Charles C. Buck

Forest Service, U.S. Department of Agriculture

MAY 1970

U.S. DEPARTMENT OF AGRICULTURE FOREST SERVICE * AGRICULTURE HANDBOOK 360

CONTENTS

	Page
PREFACE -----	IV
INTRODUCTION -----	V
CHAPTER 1. BASIC PRINCIPLES ----- The primary causes of the actions, reactions, and interactions of the components of the atmosphere and the elements of weather need to be understood because the behavior of wildland fire depends upon them.	I
CHAPTER 2. TEMPERATURE ----- The continual changes in land, sea, and air temperatures from hot to cold during day and night and summer and winter affect fire-weather judgments and predictions.	19
CHAPTER 3. ATMOSPHERIC MOISTURE ----- The amount of water vapor in the air-the degree of "wetness" and "dryness" as a condition of fire weather-must be considered in all evaluations of wildland fire potential and control.	33
CHAPTER 4. ATMOSPHERIC STABILITY ----- The distributions of temperature and moisture aloft, although difficult to perceive thousands of feet above the surface, can critically influence the behavior of a wildland fire.	49
CHAPTER 5. GENERAL CIRCULATION ----- Large-scale circulation of air and moisture in the atmosphere sets the regional patterns for both long-term trends and seasonal variations in fire weather.	68
CHAPTER 6. GENERAL WINDS ----- An understanding of the mechanics of wind flow as measured and expressed in terms of speed and vertical and horizontal directions, both regionally and locally, are of extreme importance to the wildland fire-control man.	85
CHAPTER 7. CONVECTIVE WINDS ----- Local surface conditions resulting in the heating and cooling of the surface air cause air motions which can account for "unusual" wind behavior on a wildland fire.	107
CHAPTER 8. AIR MASSES AND FRONTS ----- Both warm and cold air masses, usually coincident with high-pressure cells, migrate constantly over areas of thousands of square miles. When they are stationary, fire weather changes only gradually from day to day, but when they move and overtake or encounter other air masses, weather elements do change-often -suddenly.	127
CHAPTER 9. CLOUDS AND PRECIPITATION ----- Clouds, in both amounts and kinds, or their absence, are indicators of fire-weather conditions that must be evaluated daily. Some can locally forewarn fire-control men of high fire hazard.-Not all of them produce rain.	144
CHAPTER 10. THUNDERSTORMS ----- When a moist air mass becomes unstable, thunderstorms are likely. Their fire-starting potential and effect on fire behavior can be anticipated if the weather conditions, which produce them, are understood.	166
CHAPTER 11. WEATHER AND FUEL MOISTURE ----- The response of both living and dead forest and range fuels, the food on which wildland fire feeds, to atmospheric and precipitated moisture affect wildland fire prevention and control.	180
CHAPTER 12. FIRE CLIMATE REGIONS ----- An overall look and a summary of regional fire-weather characteristics are very helpful to the wildland fire-control man who travels or changes headquarters frequently.	196
INDEX -----	221

PREFACE

Weather is never static. It is always dynamic. Its interpretation is an art. The art of applying complex information about weather to the equally complex task of wildland fire control cannot be acquired easily especially not by the mere reading of a book.

The environment is in control in wildland firefighting. Free-burning fires are literally nourished by weather elements, atmospheric components, and atmospheric motion. Out-guessing Mother Nature in order to win control is an extremely difficult task. We need to soothe her with understanding.

We have attempted to present information in such a way that your daily and seasonal awareness of fire weather can begin with reliable basic knowledge. We have kept the use of technical terms to a minimum, but where it was necessary for clear and accurate presentation, we have introduced and defined the proper terms. Growing awareness of fire weather, when combined with related experience on fires, can develop into increasingly intuitive, rapid, and accurate applications. Toward this end, we have preceded each chapter with a paragraph or two on important points to look for in relating weather factors to fire control planning and action.

The illustrations are designed to help you "see" the weather from many different locations. Sometimes you will need a view of the entire North American Continent-other times you will look at a small area covering only a few square miles or even a few square yards. The illustrations should help you to evaluate fire weather in all of its dimensions, and simultaneously to keep track of its continually changing character.

In the illustrations, **red** represents **heat**, and **blue** represents **moisture**. Watch for changes in these two most important factors and how they cause changes in all other elements influencing fire behavior.

Assistance in the form of original written material, reviews, and suggestions was received from such a large number of people that it is not practical to acknowledge the contribution of each individual.

They are all members of two agencies:

U.S. Department of Commerce,
Environmental Science Services
Administration,

Weather Bureau and U.S. Department of
Agriculture, Forest Service.

Their help is deeply appreciated, for without it this publication would not have been possible.

INTRODUCTION

What is WEATHER? Simply defined, it is the state of the atmosphere surrounding the earth. But the atmosphere is not static-it is constantly changing. So we can say that weather is concerned with the changing nature of the atmosphere. Familiar terms used to describe weather are

- Temperature
- Pressure
- Wind speed
- Wind direction
- Humidity
- Visibility
- Clouds
- Precipitation

The atmosphere is a gaseous mantle encasing the earth and rotating with it in space. Heat from the sun causes continual changes in each of the above elements. These variations are interdependent; affecting all elements in such a manner that weather is ever changing in both time and space.

Because weather is the state of the atmosphere, it follows that **if there were no atmosphere there would be no weather**. Such is the case on the moon. At high altitudes, where the earth's atmosphere becomes extremely thin, the type of weather familiar to us, with its clouds and precipitation, does not exist.

The varying moods of the ever-changing weather found in the lower, denser atmosphere affect all of us. Sometimes it is violent, causing death and destruction in hurricanes, tornadoes, and blizzards. Sometimes it becomes balmy with sunny days and mild temperatures. And sometimes it is oppressive with high humidities and high temperatures. As the weather changes, we change our activities, sometimes taking advantage of it and at other times protecting ourselves and our property from it.

A farmer needs to understand only that part of the shifting weather pattern affecting the earth's surface-and the crop he grows.

The launcher of a space missile must know, from hour to hour, the interrelated changes in weather in the total height of the atmosphere, as far out as it is known to exist, in order to make his decisions for action.

But the man whose interest is wildland fire is neither limited to the surface nor concerned with the whole of the earth's atmosphere. The action he takes is guided by understanding and interpreting **weather variations in the air layer up to 5 or 10 miles above the land**. These variations, when described in ways related to their influences on wildland fire, constitute FIRE WEATHER. When fire weather is combined with the two other factors influencing fire behavior-**topography and fuel** - a basis for judgment is formed.

Chapter I

BASIC PRINCIPLES

Wildland fires occur in and are affected by the condition of the lower atmosphere at any one moment and by its changes from one moment to the next. At times, fires may be affected only by the changes in a small area at or near the surface; at other times, the region of influence may involve many square miles horizontally and several miles vertically in the atmosphere. All these conditions and changes result from the physical nature of the atmosphere and its reactions to the energy it receives directly or indirectly from the sun.

This chapter presents basic atmospheric properties and energy considerations that are essential to understand why weather and its component elements behave as they do. We can see or feel some of these component elements, whereas others are only subtly perceptible to our senses. But these elements are measurable, and the measured values change according to basic physical processes in the atmosphere. These changes in values of weather elements influence the ignition, spread, and intensity of wildland fires.

BASIC PRINCIPLES

LAYERS OF THE ATMOSPHERE

It is convenient for our purposes to divide the atmosphere into several layers based primarily on their temperature characteristics. The lowest layer is the **troposphere**. Temperature in the troposphere decreases with height, except for occasional shallow layers. This temperature

structure allows vertical motion and resultant mixing. Hence, this is a generally mixed, sometimes turbulent layer. Here occur practically all clouds and storms and other changes that affect fire. In this layer, horizontal winds usually increase with height.

The depth of the troposphere varies from about 5 miles over the North and South Poles to about 10 miles over the Equator. In temperate and Polar Regions, the depth increases somewhat in the summer and decreases somewhat in the winter. In the temperate regions, the depth will vary even within seasons as warm or cold air invades these regions.

The troposphere is capped by the **tropopause** - the transition zone between the troposphere and the **stratosphere**. The tropopause is usually marked by a temperature minimum. It indicates the approximate top of convective activity.

Through most of the stratosphere, the temperature either increases with height or decreases slowly. It is a stable region with relatively little turbulence, extending to about 15 miles above the earth's surface.

Above the stratosphere is the **mesosphere**, extending to about 50 miles. It is characterized by an increase in temperature from the top of the stratosphere to about 30 miles above the earth's surface, and then by a decrease in temperature to about 50 miles above the surface.

The **thermosphere** is the outermost layer, extending from the top of the mesosphere to the threshold of space. It is characterized by a steadily increasing temperature with height.

Let us now return to our principal interest - the troposphere - and examine it a little more closely. The troposphere is a region of change - able weather. It contains about three-quarters of the earth's atmosphere in weight, and nearly all of its water vapor and carbon dioxide.

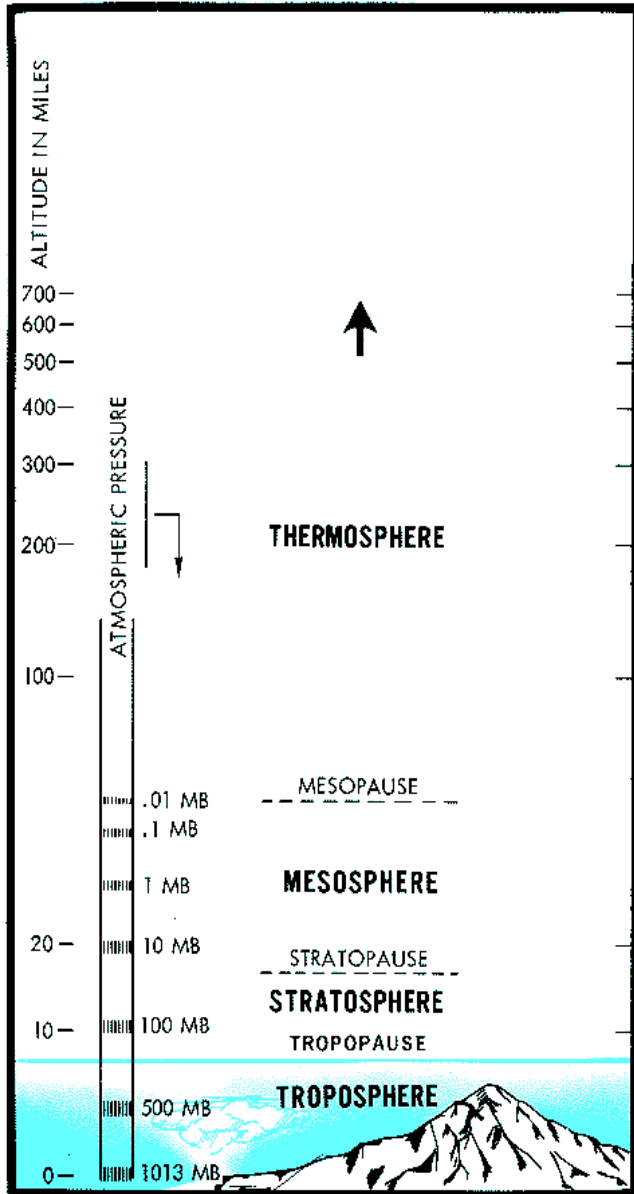

Pressure decreases rapidly with height through the troposphere and stratosphere.

Composition of the Troposphere

Air in the troposphere is composed mostly of two gases. Dry air consists of about 78 percent nitrogen by volume and about 21 percent oxygen. Of the remainder, argon comprises about 0.93 percent and carbon dioxide about 0.03 percent. Traces of several other gases account for less than 0.01 percent.

In addition to these gases, the troposphere contains a highly variable amount of water vapor—from near zero to 4 or 5 percent. Water vapor tends to act as an independent gas mixed with the air. It has a profound effect on weather processes, for without it there would be no clouds and no rain. Variations in the amount of water vapor influence the moisture content and flammability of surface fuels.

The troposphere also contains salt and dust particles, smoke, and other industrial pollutants. These impurities affect the visibility through the atmosphere and also may serve as nuclei for the condensation of water vapor in cloud formation.

Air, although not heavy compared with other familiar substances, does have measurable mass and responds accordingly to the force of gravity. At the outer limits of the atmosphere, the air is extremely rarefied, each cubic foot

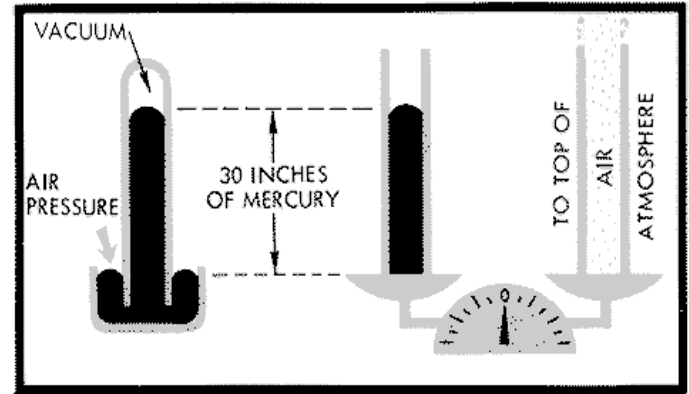

A column of air from sea level to the top of the atmosphere weighs about the same as a 30-inch column of mercury of the same diameter.

containing only a few molecules and weighing virtually nothing. At sea level, however, a cubic foot of air, compressed by all the air above it, contains many molecules and weighs 0.08 pounds at 32°F. The total weight of a 1-inch-square column of air extending from sea level to the top of the atmosphere averages 14.7 pounds. This is the normal pressure exerted by the atmosphere at sea level and is referred to as the **standard atmospheric pressure**.

A common method of measuring pressure is that of comparing the weight of the atmosphere with the weight of a column of mercury. The atmospheric pressure then may be expressed in terms of the height of the column of mercury. The normal value at sea level is 29.92 inches. A more common unit of pressure measurement used in meteorology is the millibar (mb.). A pressure, or barometer, reading of 29.92 inches of mercury is equivalent to 1013.25 mb. While this is the standard atmospheric pressure at sea level, the actual pressure can vary from 980 mb. or less in low-pressure systems to 1050 mb. or more in high-pressure systems.

Atmospheric pressure decreases with increasing altitude. Measured at successive heights, the weight of a column of air decreases with increasing altitude. The rate of decrease is about 1 inch of mercury, or 34 mb., for each 1,000 feet of altitude up to about 7,000 feet. Above about 7,000 feet, the rate of decrease becomes steadily less. In midlatitudes the 500 mb. level is reached at an average altitude of about 18,000 feet. Thus, nearly half the weight of the atmosphere is below this altitude, or within about 3 1/2 miles of the surface.

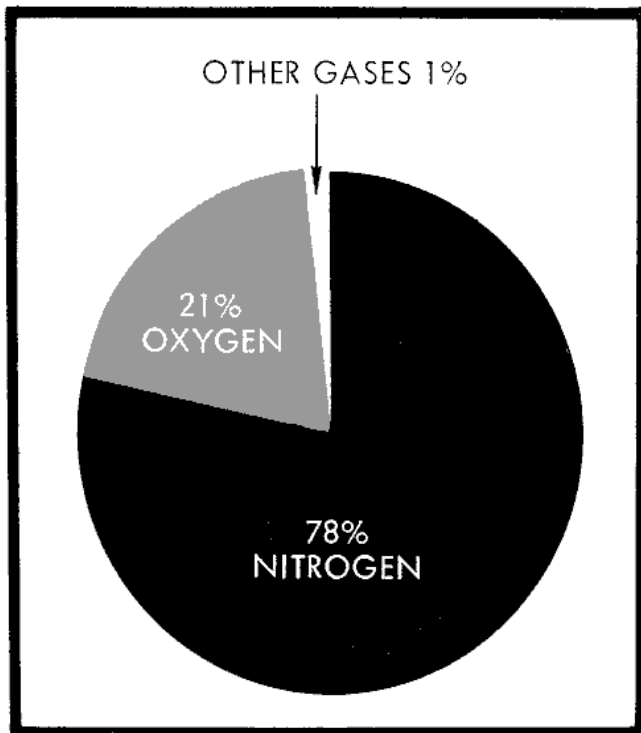

Air in the troposphere is composed mostly of two gases – nitrogen and oxygen.

ENERGY IN THE TROPOSPHERE

Tremendous quantities of energy are fed into the troposphere, setting it in motion and making it work in many ways to create our ever-changing weather. At any time and place, the energy may be in any one form or a combination of several forms. All energy, however, comes either directly or indirectly from the sun.

Simply defined, **energy** is the capacity to do work. Its more common forms are heat or **thermal** energy, radiant energy, **mechanical** energy (which may be either **potential** or **kinetic**), **chemical** energy, and **electrical** energy. There are also **atomic, molecular, and nuclear** energy.

Energy can be, and constantly is being, transformed from one form to another, but energy is always conserved in the process. It cannot be created nor destroyed, although a transformation between energy and mass does occur in atomic reactions.

Kinetic energy is energy of motion, whereas potential energy is energy due to position, usually with respect to the earth's gravitational field. The motion of a pendulum is a good example of the interchange of potential and kinetic energy. At the end of its swing, a pendulum has potential energy that is expended in the down stroke and converted to kinetic energy. This kinetic energy lifts the pendulum against the force of gravity on the upstroke, and the transformation back to the potential energy occurs. Losses caused by friction of the system appear in the form of heat energy. The sun is the earth's source of heat and other forms of energy.

The common storage battery in charged condition possesses chemical energy. When the battery terminals are connected to a suitable conductor, chemical reaction produces electrical energy. When a battery is connected to a motor, the electrical energy is converted to mechanical energy in the rotation of the rotor and shaft. When the terminals are connected to a resistor, the electrical energy is converted to thermal energy. When lightning starts forest fires, a similar conversion takes place.

Energy is present in these various forms in the atmosphere. They are never in balance, however, and are constantly undergoing con-

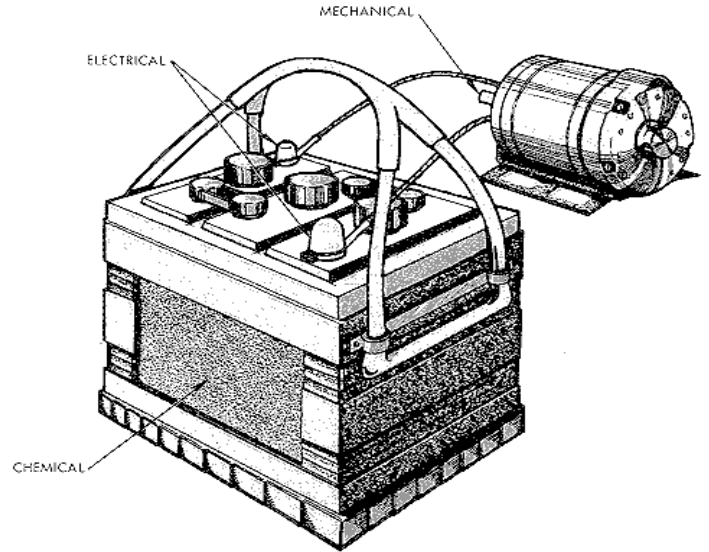

Chemical energy can be transformed into electrical energy, which in turn can be transformed into mechanical energy or thermal energy.

version from one form to another, as in the case of the pendulum or the storage battery. Their common source is the radiant energy from the sun. Absorption of this energy warms the surface of the earth, and heat is exchanged between the earth's surface and the lower troposphere.

Heat Energy and Temperature

Heat energy represents the total molecular energy of a substance and is therefore dependent upon both the number of molecules and the degree of molecular activity. **Temperature**, although related to heat, is defined as the degree of the hotness or coldness of a substance, determined by the degree of its molecular activity. Temperature reflects the **average** molecular activity and is measured by a thermometer on a designated scale, such as the Fahrenheit scale or the Celsius scale.

If heat is applied to a substance, and there is no change in physical structure (such as ice to water or water to vapor), the molecular activity increases and the temperature rises. If a substance loses heat, again without a change in physical structure, the molecular activity decreases and the temperature drops.

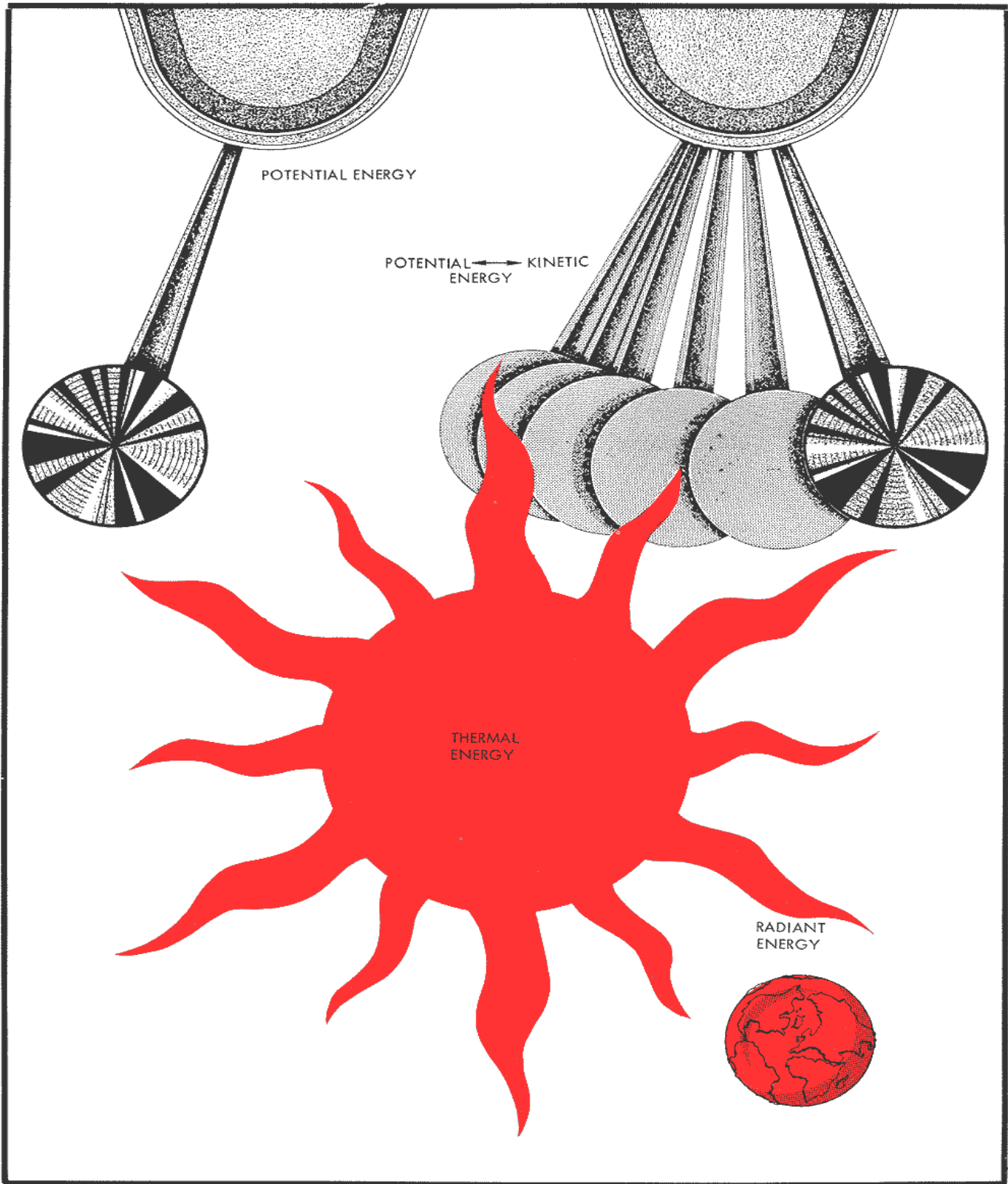

All forms of energy in the atmosphere stem originally from the radiant energy of the sun that warms the surface of the earth. Energy changes from one to another in the atmosphere; so does energy in a swinging pendulum.

Heat and temperature differ in that heat can be converted to other forms of energy and can be transferred from one substance to another, while temperature has neither capability. Temperature, however, determines the direction of net heat transfer from one substance to another. Heat always flows from the substance with the higher temperature to the one with the lower temperature, and stops flowing when the temperatures are equal. In this exchange of heat, the energy gained by the cooler substance equals that given up by the warmer substance, but the temperature changes of the two are not necessarily equal.

Since different substances have different molecular structures, the same amount of heat applied to equal masses of different substances will cause one substance to get hotter than the other. In other words, they have different heat capacities. A unit of heat capacity used in the English system of measures is the **British thermal unit (B.t.u.)**. One B.t.u. is the amount of heat required to raise the temperature of 1 pound of water 1°F.

The ratio of the heat capacity of a substance to that of water is defined as the **specific heat** of the substance. Thus, the specific heat of water is 1.0—much higher than the specific heat of other common substances at atmospheric temperatures. For example, most woods have specific heats between 0.45 and 0.65; ice, 0.49; dry air, 0.24; and dry soil and rock, about 0.20. Thus, large bodies of water can store large quantities of heat and therefore are great moderators of temperature.

If heat flows between two substances of different specific heats, the resulting rise in temperature of the cooler substance will be different from the resulting decrease in temperature of the warmer substance. For example, if 1 pound of water at 70°F. is mixed with 1 pound of gasoline, specific heat 0.5, at 60°F., the exchange of heat will cause the temperature of the gasoline to rise twice as much as this exchange causes the water temperature to lower. Thus, when 3 1/3 B.t.u. has been exchanged, the pound of water will have decreased 3 1/3°F. and the pound of gasoline will have increased 6 2/3°F. The temperature of the mixture will then be 66 2/3°F.

With minor exceptions, solids and liquids expand when their molecular activity is increased by heating.

They contract as the temperature falls, and the molecular activity decreases. The amount of expansion or contraction depends on the size, the amount of temperature change, and the kind of substance. The expansion and contraction of liquid, for example, is used in a thermometer to measure temperature change. Thus, volume changes with temperature, but at any given temperature the volume is fixed.

The reaction of gases to temperature changes is somewhat more complex than that of liquids or solids. A change in temperature may change either the volume or pressure of the gas, or both. If the volume is held constant, the pressure increases as the temperature rises and decreases as the temperature falls.

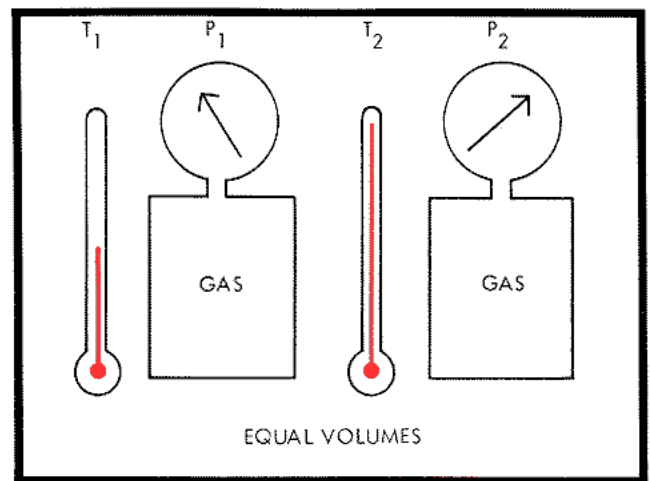

If the volume of a gas is held constant, the pressure increases as the temperature rises, and decreases as the temperature falls.

Since the atmosphere is not confined, atmospheric processes do not occur under constant volume. Either the pressure is constant and the volume changes, or both pressure and volume change. If the pressure remains constant, the volume increases as the temperature rises, and decreases as the temperatures falls. The change in volume for equal temperature changes is much greater in gases under constant pressure than it is in liquids and solids. Consequently, changes in temperature cause significant changes in **density** (mass per unit volume) of the gas. Rising temperature is accompanied by a decrease in density, and falling temperature is accompanied by an increase in density.

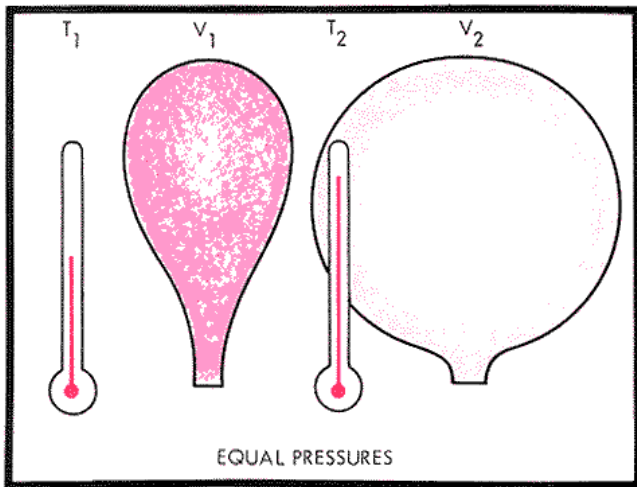

Under constant pressure, the volume increases and the density decreases as temperature rises, and the volume decreases and the density increases as temperature falls.

When gas expands, it must perform work in the process and therefore expend some of its internal (molecular) energy. Decreasing the internal energy lowers the temperature. Therefore, expansion is essentially a cooling process. Conversely, when a gas is compressed, work is done **on** the gas and this results in an increase

in the internal energy of the gas. Thus, compression is a heating process. Compression and expansion are continuing processes in the atmosphere and account for both stabilization and change in weather activity.

Changes of State

Much more dramatic, because of the greater energy levels involved, are the transformations in our atmosphere between solid (ice) and liquid (water), and also between liquid (water) and gas (water vapor). These "change of state" transformations account for much of the energy involved in weather phenomena.

If a block of ice is heated continuously, its temperature will rise until it reaches the melting point, 32°F. The ice will then begin to melt, and its temperature will remain at 32°F. until all of the ice is melted. The heat required to convert 1 pound of ice into liquid water at 32°F. is 144 B.t.u. This is known as the **heat of fusion**. Continued heating will cause the temperature of the liquid water to rise until it reaches the boiling point, 212°F. (at sea-level pressure). The water will then begin to

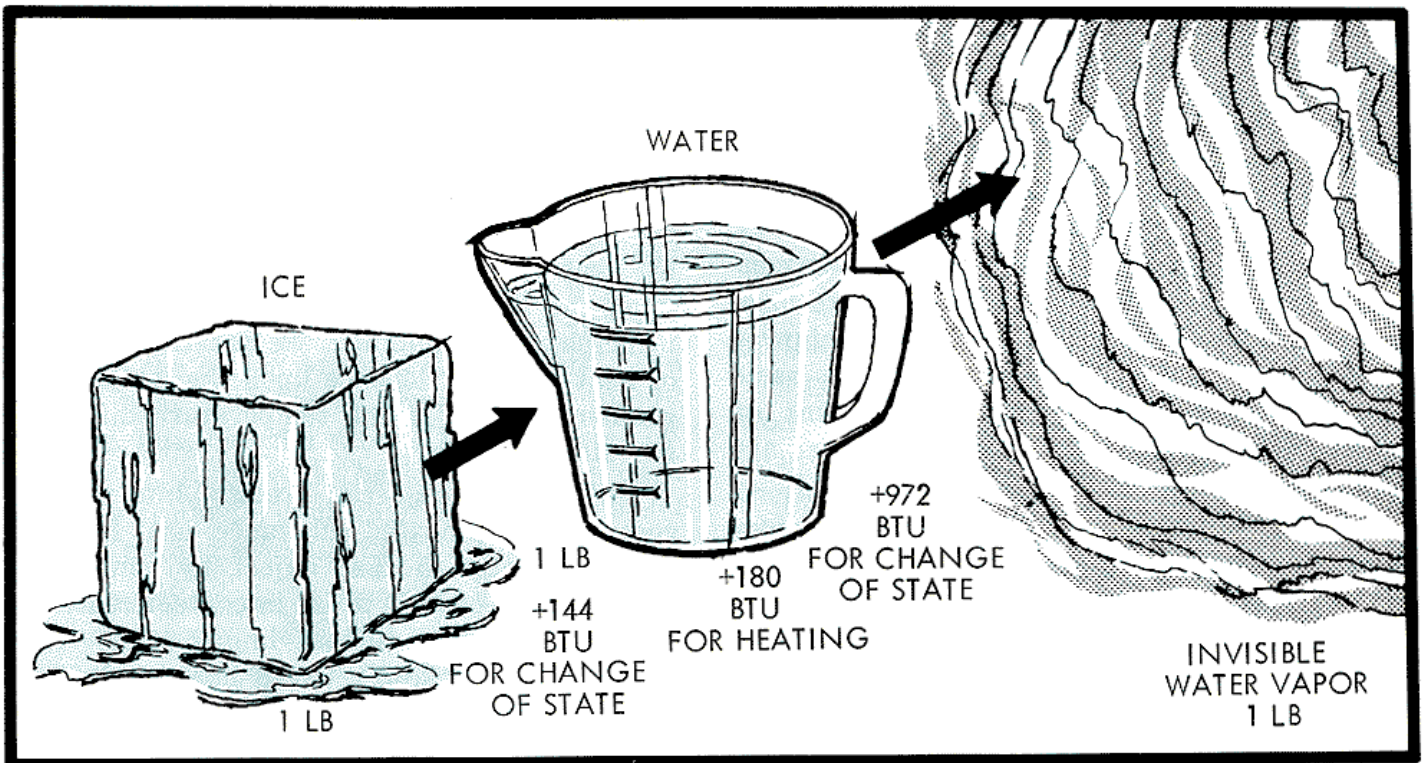

To change ice at 32°F. to water vapor at 212°F. at sea-level pressure requires the addition of: (1) The heat of fusion, (2) the heat required to raise the temperature of the water to the boiling point, and (3) the heat of vaporization.

change to vapor, and its temperature will remain at 212°F. until all of the water is changed to vapor. The heat required to change 1 pound of water into vapor at 212°F. is 972 B.t.u. This is known as the **heat of vaporization**. Through **evaporation**, water will change to vapor below 212°F. However, the amount of heat required at lower temperatures is somewhat higher than at the boiling point. At 86°F., for example, 1,044 B.t.u. would be required to change 1 pound of water into vapor.

When this process is reversed—and vapor changes to liquid water and water changes to ice—the same amounts of heat energy are released. The **condensation** of water vapor into liquid water, during the formation of clouds and precipitation, furnishes a tremendous amount of energy to the atmosphere. About 1,000 times as much heat is released by condensation as by the cooling of a similar amount of water 1 Fahrenheit degree.

At subfreezing temperatures, water in the solid state—such as ice, snow, or frost—may change directly into vapor. For example, on very cold, dry days, snow will vaporize without first changing to liquid. At subfreezing temperatures, water vapor will also change directly into snow or frost. Either process is known as **sublimation**. The amount of heat involved in sublimation equals the sum of the heat of fusion and the heat of vaporization.

Principles of Heat Transfer

We have already seen that heat can be converted to other forms of energy and then back to heat. Heat can also flow between substances or within a substance by one of three basic processes without involving other forms of energy. These direct transfer processes are **conduction, convection, and radiation**.

Conduction is the transfer of heat by molecular activity. As the first molecules are heated, they are speeded up, and this energy is transferred to adjacent molecules, etc. Heat applied to one portion of a metal rod increases the molecular activity and the temperature in that part of the rod. This increased molecular activity is imparted to adjacent molecules, and the temperature thus increases progressively along the rod.

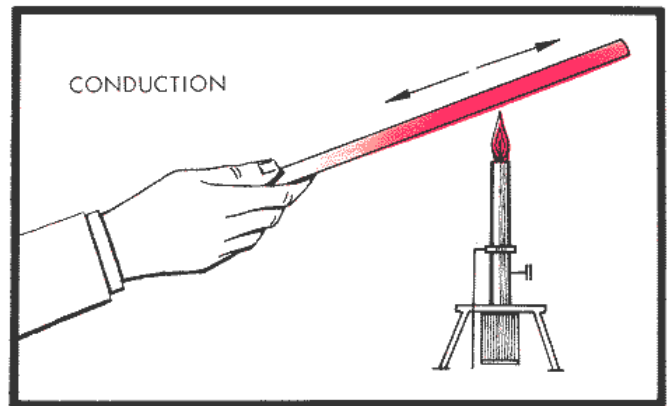

Heat added to one portion of a metal rod is conducted away, and the temperature rises progressively along the rod.

Some substances, such as copper, are good heat conductors. In copper-clad kitchenware, for example, heat is quickly and evenly distributed over the bottom of the utensils. Other substances like glass, wood, paper, and water are poor conductors. Forest litter is also a poor conductor. Most gases, including air, are poor conductors; for example, dead airspaces are used in the walls of buildings as insulation to prevent rapid heat exchange.

The rate at which heat moves between or within substances is affected by the **temperature difference** between the source of heat and the substance or part of the substance being heated, as well as by the **thermal conductivity** of the material. The rate of heat transfer is directly proportional to this temperature difference. Within a given substance, such as a metal rod, the rate at which the cold end is heated by heat traveling from the hot end depends upon the length of the rod. When these two principles are combined, we see that the rate of heat transfer depends upon the **temperature gradient**, which is the temperature difference per unit distance.

If another object is brought into physical contact with a heated substance, heat is transferred directly to that object by conduction. The surfaces of both areas in contact reach the same temperature almost immediately. Heat will continue to flow between both surfaces at a rate determined by the speed with which additional heat can be fed to the heating surface, and by the speed with which the receiving surface can dissipate its heat into the absorbing material. For solid objects, the rate is deter-

mined by the thermal conductivities of the respective materials, the size of the contact area, and the temperature gradients established within the contacting bodies.

In the atmosphere, the principal role of conduction is the heating and cooling of the air as it contacts hot or cold surfaces. A shallow layer adjacent to the ground is heated during the day and cooled at night.

Convection is the transfer of heat within liquids and gases resulting from the motion of the fluid. Convection is much faster than conduction. When heat is applied to the bottom of a pan of water, the water touching the bottom of the pan is heated by conduction. As this portion of the water is heated, it expands and becomes less dense than the surrounding water. Any substance surrounded by a more dense fluid is forced to rise by **buoyant forces** imposed on the less dense substance. The cooler, more dense fluid flows in to replace the warmer, less dense fluid that rises. The rate of flow depends upon the differences in density produced by the differences in temperature.

By placing one or two drops of dye in the water, the patterns of rising and sinking currents will be shown. By this convective circulation, the mass transfer of water carrying its acquired heat with it eventually heats the entire pan of water. As the convection continues, the dye becomes evenly distributed in the water, producing a uniform color. Thus, convection is also a mixing process,

Convection is the initial motion responsible for the development of wind currents in the troposphere, and as a mixing process it is responsible for the transfer of heat from the hotter to the cooler portions of the earth. The rate of heat transfer by convection is highly variable, but, like the rate of heat transfer by conduction, it depends basically on the temperature gradients resulting from unequal heating and cooling over the earth's surface.

Convection is extremely important in weather processes and will be referred to frequently in later chapters, particularly when the general circulation and smaller scale winds are discussed.

Radiation is the transfer of energy by electromagnetic waves moving at the speed of light, 186,000 miles per second. This process,

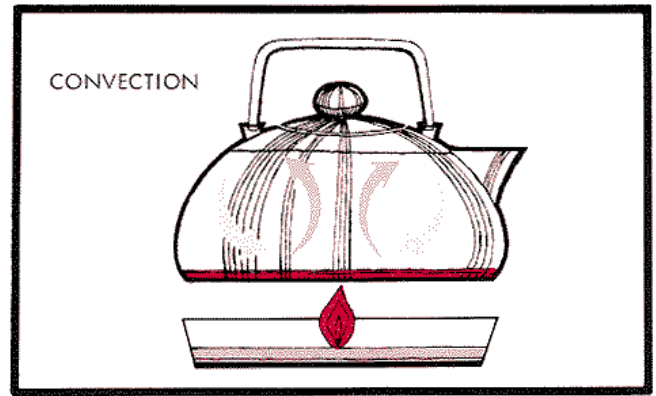

Heating a kettle of water sort up convection currents which transfer heat throughout the water,

unlike conduction and convection, does not require the presence of intervening matter. Transfer of energy by radiation occurs over a wide spectrum of wavelengths ranging from very long radio waves to extremely short X-rays, gamma rays, and cosmic rays. Visible light appears near the middle of this range.

We will be concerned only with that portion of the spectrum in which radiation acts as a heat-transfer mechanism. This radiation occupies the electromagnetic spectrum from the shortest ultraviolet wavelengths, through visible light, to the longest infrared wavelengths. Only radiation in this part of the spectrum is important in weather processes in the troposphere. We refer to this radiation as **thermal radiation**. Thermal radiation is emitted by any substance when its molecules are excited by thermal energy.

Heat transfer by radiation is accomplished by the conversion of thermal energy to radiant energy. The radiant energy travels outward from the emitting substance and retains its identity until it is absorbed and reconverted to thermal energy in an absorbing substance. The emitting substance loses heat and becomes cooler, while the absorbing substance gains heat and becomes warmer in the process. Radiant energy reflected by a substance does not contribute to its heat content.

All substances radiate energy when their temperatures are above absolute zero (-4600P.), the temperature at which all molecular motion ceases. The intensity and wavelength of the radiation depend upon the tom-

perature and the nature of the radiating substance. At low temperatures, all the radiation is in the invisible long wavelengths or infrared range. As the temperature rises, radiation increases in progressively shorter wavelengths as well as in the longer wavelengths. The increase, however, is faster in short-wave radiation than in long wave radiation. Therefore, as the temperature of the radiating surface increases, the maximum radiation intensities shift toward shorter and shorter wavelengths.

With increasing temperature, the visible spectrum appears in the following order: Dull red, bright red, orange, yellow, and white. All radiation from the earth is in the long wave or infrared range, while most radiation from the sun is in the short wave or visible range.

Not all substances are good radiators. Opaque substances are better radiators than transparent substances. Among solid materials, nonmetals are better radiators than metals, particularly at lower temperatures. The ideal radiator would be one capable of emitting the maximum heat at all wavelengths. Since black surfaces approach this emittance most nearly, the perfect radiator is called a **black body**. The **emissivity** of any substance is the ratio of its radiation, at any specified wavelength and temperature, to that of a black body at the same wavelength and temperature. The highest value of emissivity is one, and the lowest value is zero.

The intensity of the thermal radiation emitted by any substance depends upon its temperature. Actually, the intensity is proportional to the fourth power of the temperature.¹ If the Kelvin temperature of the emitting substance doubled, the radiation intensity would increase 2^4 or 16 times.

The intensity of radiant energy received by a substance depends on two factors in addition to the intensity of the radiation at the source. These are the **distance** between the radiator and the substance and the **angle** at which the radiation strikes the substance.

Since radiation travels outward in straight lines, the intensity of thermal radiation received

from a point source will vary inversely as the square of the distance of the receiving substance from the source. The amount of energy received 3 feet from the source will be only one-ninth the amount received 1 foot from the source. From a larger radiating surface, the combined effects from all of the points within the surface must be considered. The reduction in intensity with distance is then somewhat less than from a point source. For practical purposes we may consider the sun as being a point source of radiant energy.

The amount of radiant energy received by a unit area will be greater if the receiving surface is perpendicular to the radiation than if it is at an angle other than perpendicular. A beam of the same width striking at such an angle must cover a larger surface area than a beam striking perpendicularly. As we will see later, the angle not only affects the amount of radiation received from the sun at different times during the day, but it is also the cause of our seasons.

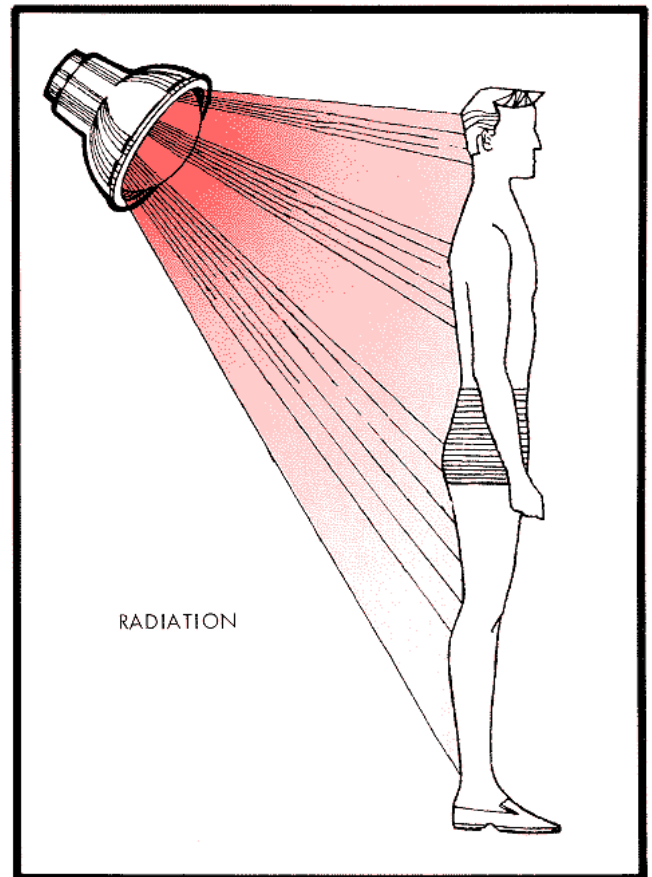

The intensity of radiation decreases as the distance from the source increases.

¹ For the relationship the temperature must be expressed by use of absolute (Kelvin) scale where 0°K. is -460°F.

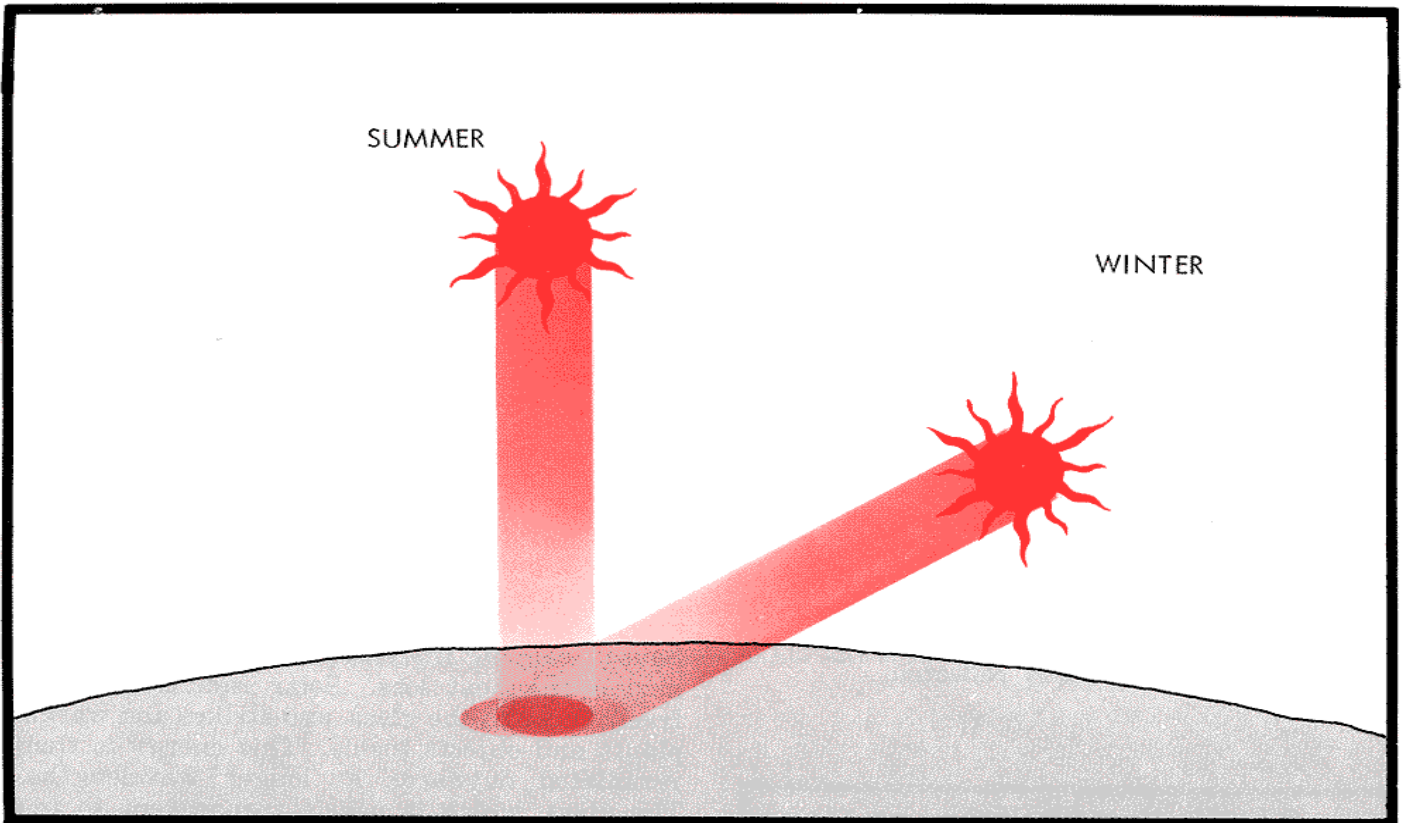

A beam of radiation of the same width striking at an angle must cover a larger surface area than a beam striking perpendicularly.

Substances vary in their ability to absorb, as well as to emit, radiation. Those that are good emitters are also good absorbers at the same wavelength. Black clothing, for example, is a good absorber of the sun's radiation and should not be worn on hot days. White clothing is a good reflector and will help keep the body cool.

SOLAR RADIATION EFFECTS IN THE TROPOSPHERE

Radiation is the process by which the earth receives heat energy from the sun, about 93 million miles away. This energy is produced in the sun, where the temperature is many million degrees, by nuclear fusion, a process in which hydrogen is converted into helium. In the process, some of the sun's mass is converted to thermal energy. Although this nuclear reaction is occurring at a tremendous rate, the mass of the sun is so great that the loss of mass in millions of years is negligible.

The sun emits radiation as would a black

body at a temperature of about 10,000°F. As a result, the maximum solar radiation is in the visible portion of the electromagnetic spectrum, and lesser amounts appear on either side in the ultraviolet and infrared.

Radiation Balance Day and Night

The intensity of solar radiation received at the outer limits of the earth's atmosphere is quite constant. However, the amount that reaches the earth's surface is highly variable,

depending greatly on the amount of clouds in the atmosphere. Some solar energy is reflected back from the tops of clouds and is lost to space. In the absence of clouds, most of the solar radiation passes directly through the atmosphere and reaches the surface.

Some solar radiation is scattered in the atmosphere by gas molecules and by minute particles of solid matter. Of this scattered radiation, some is lost to space, some is absorbed by gases in the atmosphere and by solid particles such as smoke, and some reaches the earth's surface. Water vapor, ozone, and carbon dioxide each absorb radiation within certain wavelengths. If clouds are present, water droplets also absorb some radiation. Of the radiation finally reaching the earth's surface, part is absorbed and part is reflected. When cloudiness is average, the earth's surface absorbs about 43 percent, the atmosphere absorbs about 22 percent (20 of the 22 percent within the troposphere), and 35 percent is reflected.

The reflected solar radiation is unchanged in character. However, the solar radiation, which is absorbed, either by the atmosphere or by the earth, is converted back to thermal energy. It warms up the substance that absorbs it, and may then be reradiated as radiant energy at lower temperatures and longer wavelengths.

The solar radiation, which reaches the earth's surface, warms the surface. However, the earth's average temperature does not change, because the earth in turn radiates energy to the atmosphere and to space. The outgoing radiation is at the earth's temperature and has its maximum in the infrared region of the spectrum.

It is important to life on earth and to weather processes that the radiation received and that emitted by the earth are at different wavelengths. Because of this difference, **the atmosphere acts much like the glass in a greenhouse**, trapping the earth's radiation and minimizing the heat loss. Solar radiation passes freely through the glass, and strikes and warms plants and objects inside. This energy is then reradiated outwards at longer wavelengths. The glass, which is nearly transparent to the visible wavelengths, is nearly opaque to most of the infrared wavelengths. Therefore, much of the heat stays inside, and the greenhouse warms up.

In the atmosphere it is water vapor that is primarily responsible for absorbing the infrared radiation, and the greenhouse effect varies with the amount of water vapor present. It is much less in dry air over deserts than in moist air over the Tropics.

The energy that reaches the earth as direct solar radiation and diffuse sky radiation during the day is dissipated in several ways. Some of this radiation, as we have seen, is reflected back, and since this is short-wave radiation, most of it is lost to space. A large portion is absorbed and radiated back as long wave radiation, and much of this radiation, as already mentioned, is absorbed again by the water vapor in the atmosphere. Another large portion is used in the evaporation of surface moisture and is transmitted to the atmosphere as latent heat. Some is used to heat surface air by conduction and convection, and some is conducted downward into the soil. The presence

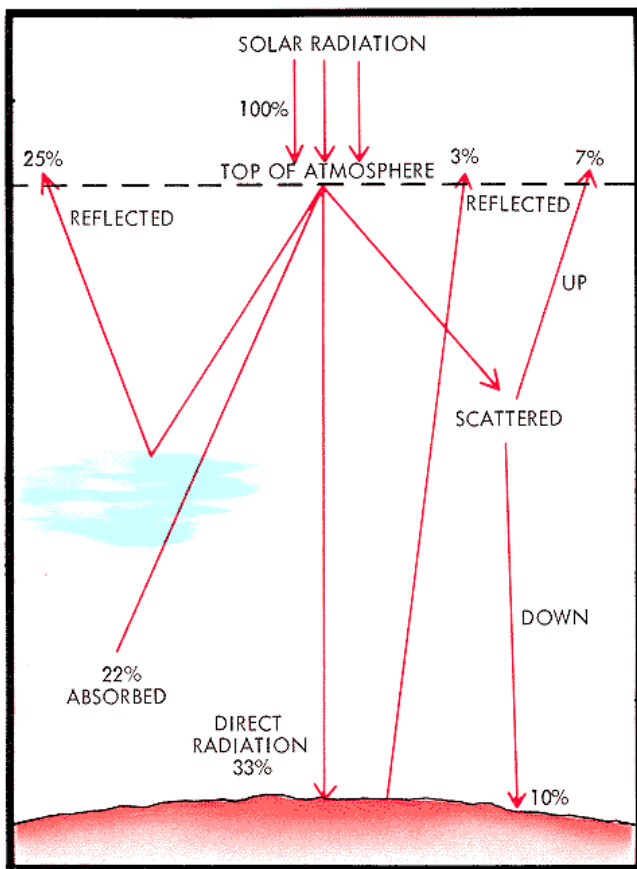

Approximate distribution of incoming solar radiation during average cloudiness.

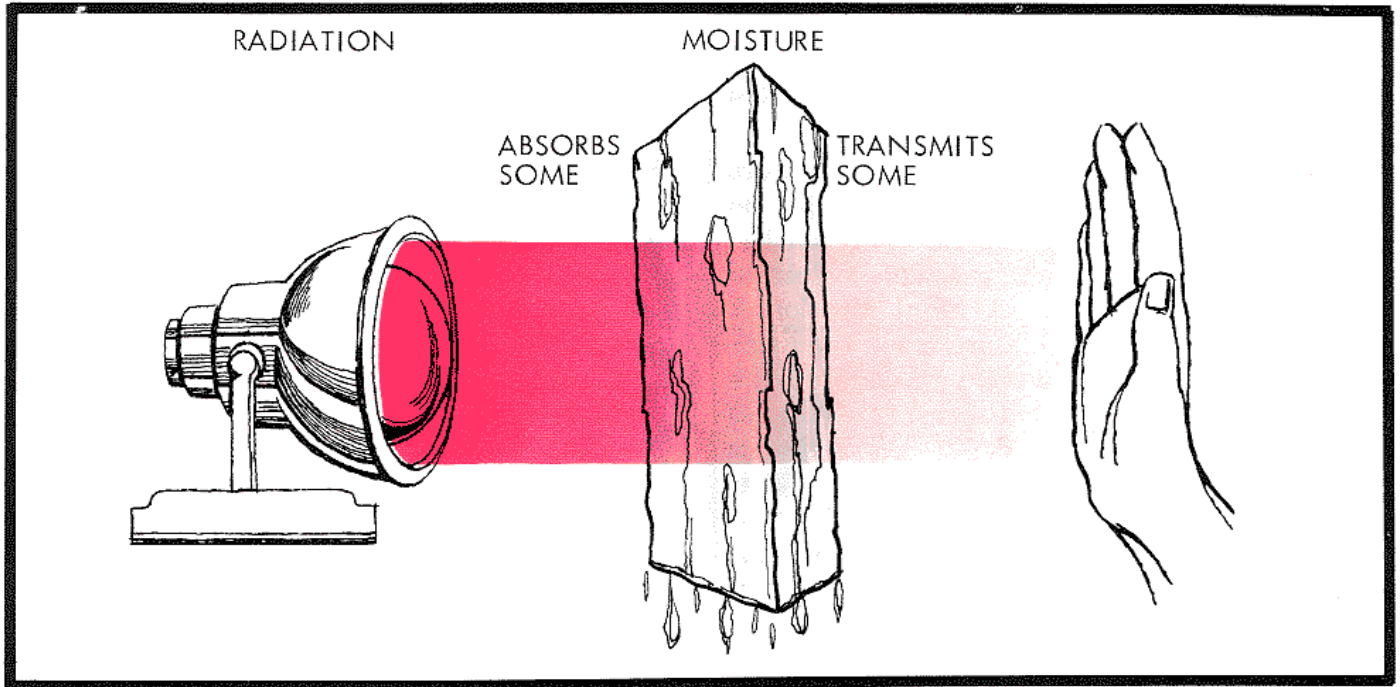

Moisture in any form-solid, liquid, or vapor-absorbs much of the long wave radiation.

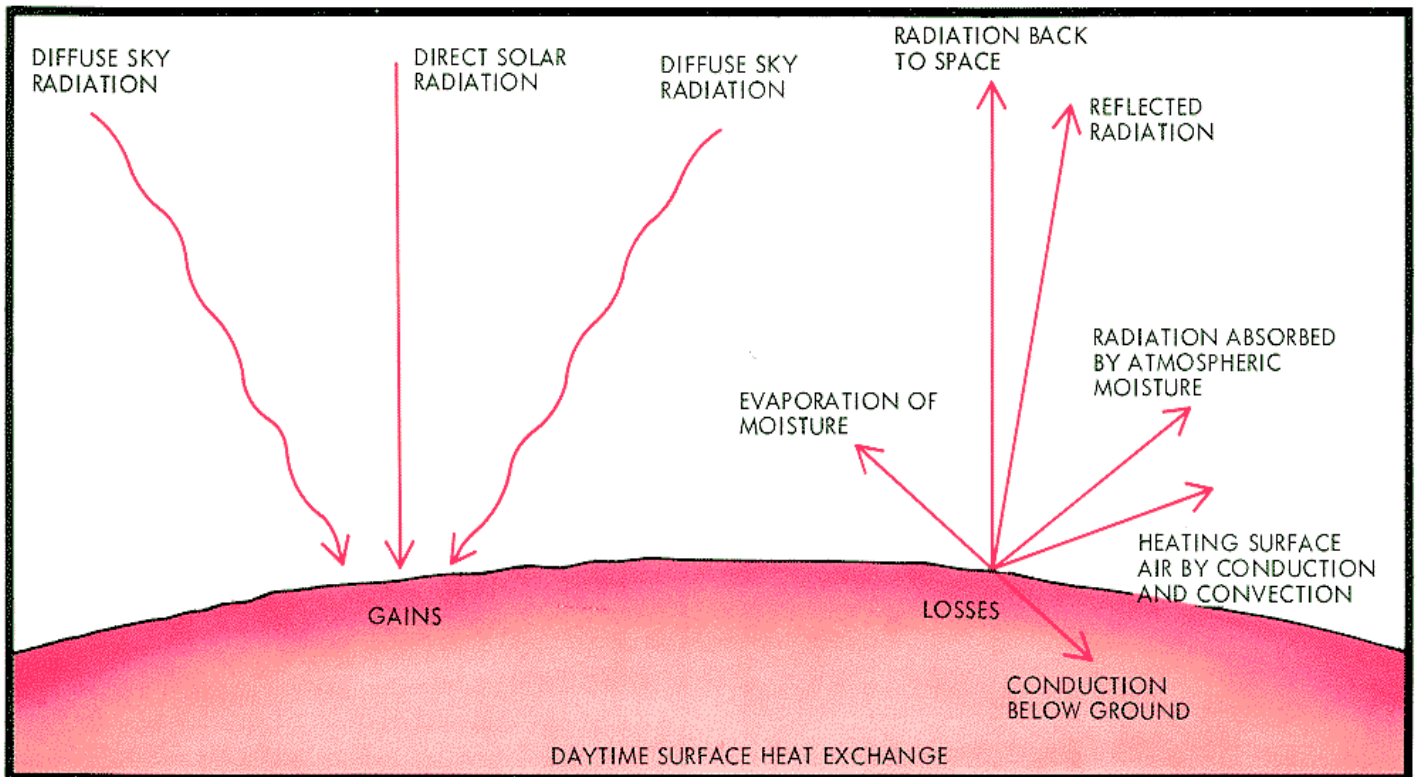

Solar radiation that reaches the earth's surface during the daytime is dissipated in several ways.

of clouds is important because clouds reflect and absorb both short-wave radiation reflected from the earth and long wave radiation emitted by the earth.

The earth radiates energy, and therefore loses heat, both day and night. At night, no appreciable solar radiation is received (on the dark side), so there is no appreciable reflection of short-wave radiation. At night the losses through long wave radiation are much the same as during the day. However, because of the cooling of the earth's surface until it becomes colder than either the air above or the deeper soil, some heat is transported back to the surface by conduction from the deeper soil below and by conduction and convection from the air above. Again, clouds influence heat losses. They are very effective in reflecting and absorbing and in reradiating energy from the earth's surface. Because of this trapping by clouds, the drop in surface temperatures is far less on cloudy nights than on clear nights.

The amount of heat received in any given area varies because of the angle with which the sun's rays strike the earth. Heating begins when the sun's rays first strike the area in the morning, increases to a maximum at noon (when the sun is directly overhead), and decreases again to near zero at sunset. The earth

warms up as long as it receives heat faster than it loses heat, and cools off when it loses heat faster than it receives it. It is this balance that results in the maximum temperature occurring about mid-afternoon instead of at the time of maximum heating, and the minimum temperature occurring near sunrise. The rate at which the earth radiates heat varies with the temperature; therefore, it is minimum at the time of the temperature minimum, and maximum at the time of the temperature maximum.

Seasons

We are all familiar with the four seasons that occur at latitudes greater than about 23° winter, spring, summer, and autumn. These seasons are due to the variation in the amount of solar radiation received by both the Northern and Southern Hemispheres throughout the year. The earth not only rotates on its axis once every 24 hours, but it also revolves around the sun in an elliptical orbit once in about 365 1/4 days. The sun is at a focus of the ellipse, and the earth is actually nearer to the sun during the northern winter than during the northern summer. But this difference in distance is much less important in relation to the earth's heating than is the inclination of the earth's axis relative to the plane of the earth's orbit.

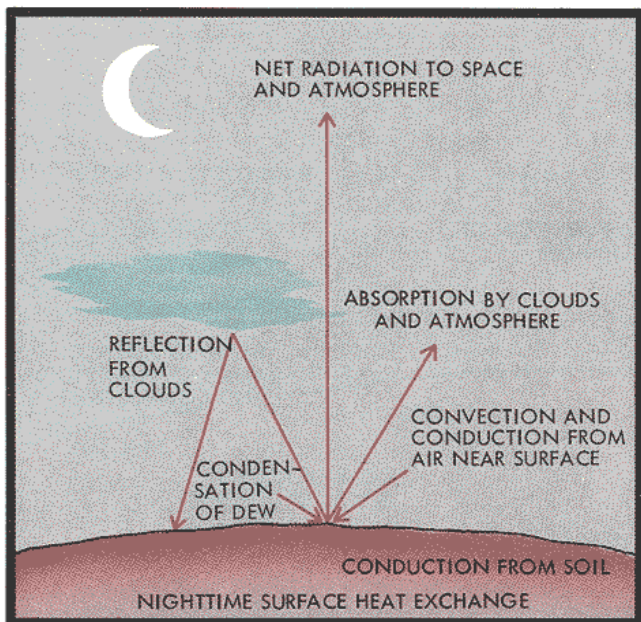

At night there is not cooling of the earth's surface although some heat is returned by various methods.

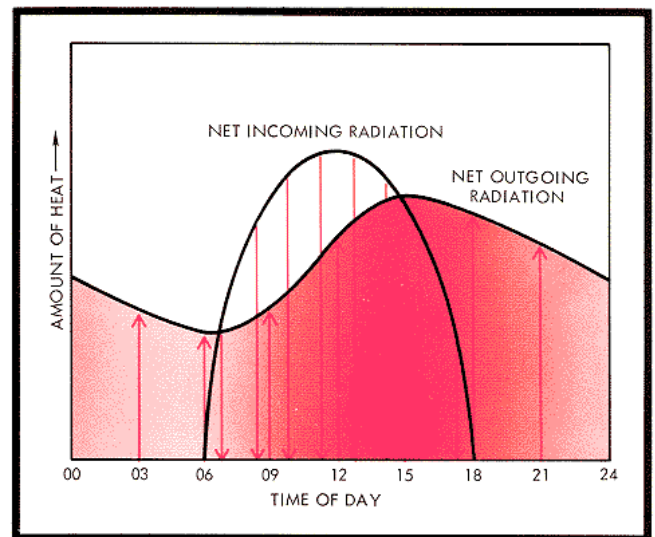

The lag in the time of maximum and minimum temperature is due to the difference between incoming and outgoing radiation.

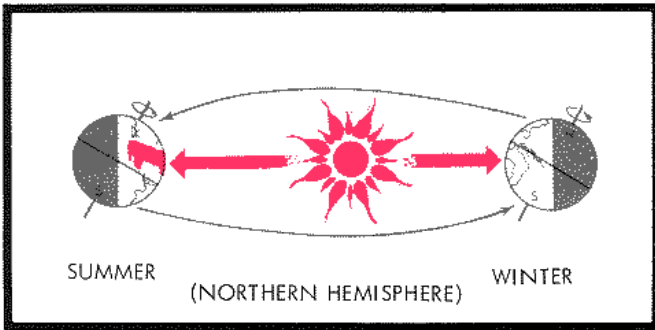

The earth rotates on its tilted axis once every 24 hours and revolves around the sun in an elliptical orbit once in about 365 ¼ days.

This inclination, or tilt, of the axis is 23 1/2 degrees from the vertical.

At all times the sunshines on half of the earth's surface. But because of the different angles with which the sun's rays strike various parts of the earth, the amount of solar radiation received per unit area varies widely. The greatest amount is received where the sun's rays strike perpendicularly. The amount diminishes toward the edge of the illuminated half where the rays become tangential to the earth's surface. If the earth's axis were not tilted, the amount of radiation any area on the earth would receive would remain nearly constant throughout the year; the revolution of the earth around the sun would have little effect on climate. (Of course climate would still vary greatly from place to place.)

Because of the tilt, however, the sun's rays strike the surface at a higher (more perpendicular) angle during the summer than during the winter; thus, more heat is received during the summer. Also, because of the inclination (tilt) of the earth's axis, the days are longer during the summer; every area away from the Equator is in the illuminated half of the earth more than half of the day. On June 21 the number of daylight hours is 12 at the Equator and increases to 24 at 66 1/2°N. and northward. In the winter the opposite is true. On December 22, the number of daylight hours is 12 at the Equator and decreases to 0 at 66 1/2°N. and northward. When the sun is directly above the Equator throughout the day, at the time of the vernal or autumnal equinox (March 21 and September 23), the (lay and night are 12 hours long everywhere.

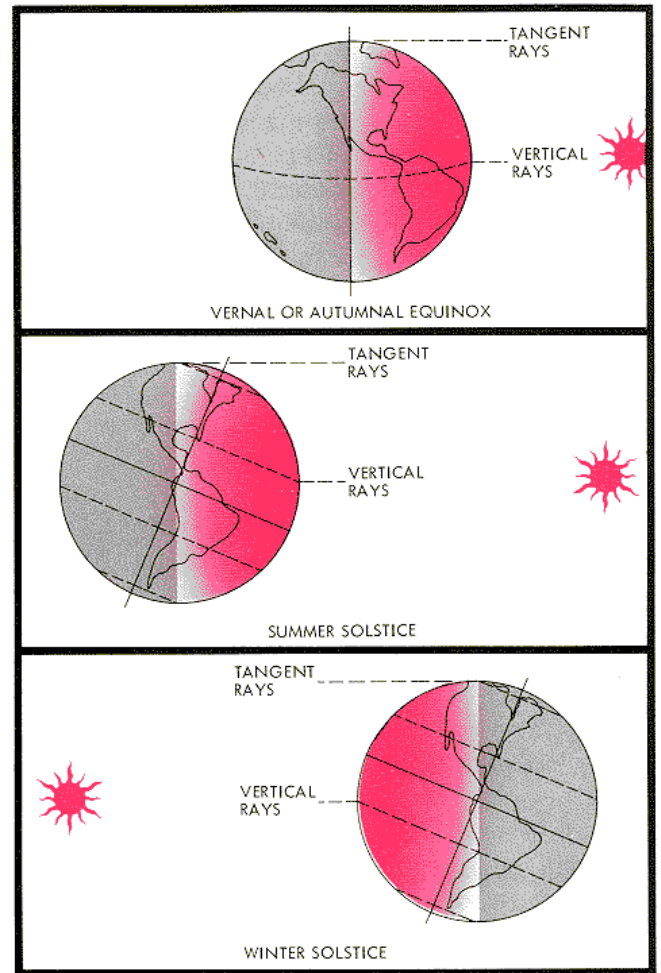

At the time of either equinox the days and nights are equal. The tilt of the earth's axis causes the sun's rays to strike the earth's surface at a higher angle during summer than during winter. Therefore, more heat is received during the summer.

The annual march of temperature has a lag similar to the lag of the daily march of temperature described above. That is, the highest normal temperatures do not occur at the time of greatest heating, nor do the lowest normal temperatures occur at the time of least heating. In the Northern Hemisphere, the warmest month is July and the coldest month is January, whereas the greatest heating takes place on June 21 and the least heating on December 21. To see why, one must look at the heat balance.

During the spring the Northern Hemisphere receives more heat each day than it radiates back to space. Consequently, its mean temperature rises. After June 21, the Northern Hemisphere begins receiving less heat each day, but the amount received is still greater than

the amount radiated, so the mean temperature still rises. In July, in the Northern Hemisphere, at the time the amount received is equal to the amount radiated, the mean temperature is highest. Thereafter, the amount received each day is less than the amount radiated, so the mean temperature declines. The time of lowest normal temperature may be similarly explained.

Of course, the temperature curve for any given year at any one place may vary considerably from the normal for that place. This is not due to a variation in the amount of heat reaching the outer atmosphere from the sun, but rather to the predominance of either cold or warm air masses and to the predominance of either cloudy or clear weather, at various periods during the year at that location.

REACTION OF THE TROPOSPHERE TO HEATING

In this chapter we are concerned with basic concepts, which we will use in studying the ways of the weather. So far we have considered the structure of the atmosphere, thermal energy principles, and, in a general way, the heating of the earth. Now we will consider briefly how the atmosphere reacts to heating and cooling by looking at horizontal and vertical motion and atmospheric stability. These items will be treated in more detail in later chapters, but they will be introduced here because of their basic nature. Weather processes are so interrelated that it is not possible to discuss one process thoroughly without having some familiarity with the others.

in weak convection cells to very intense up drafts in thunderstorms. Compensating down drafts are occasionally severe, such as in thunderstorms, but more frequently they occur as **subsidence**-a gradual settling of the air over relatively large areas.

Heated air rises over the Equator and flows toward the poles aloft. Cooled air in turn settles over the poles and initiates return flow toward the Equator to complete the circulation. Other factors, primarily the rotation of the earth, as we will see later, complicate this simple picture. But as an end result, this sort of heat energy exchange does take place.

Weather implies motion in the atmosphere, and this motion is initiated by unequal heating. Over any long period of time, the amount of energy received and lost by the earth and atmosphere must nearly balance, since there is very little long-term change in temperatures. But at a given moment and place, the gains and losses are not in balance. **An attempt to regain balance is largely responsible- for most disturbances in the atmosphere-the weather.**

Land and water surfaces warm and cool at different rates because of their different heat transfer properties. This differential heating produces differences in pressure in the atmosphere, which in turn cause air motion. On a daily basis along the coast, temperature and pressure reversals result in local land and sea breezes. But over longer periods of time, cumulative differences in temperature and pressure develop broad areas of high and low pressure. Broad scale differences in the earth's land surfaces, which vary from bare soil to dense cover, have similar effects.

Horizontal and Vertical Motion

Since horizontal distances around the earth are so much greater than vertical depths in the lower atmosphere, most of the air motion concerned with weather is in the form of horizontal winds. These winds could not blow, however, if it were not for the continuing transport of energy aloft by vertical motion resulting from heating at the surface. Upward motions in the atmosphere range from light updrafts

In general, air sinks in high-pressure areas, flows from high- to low-pressure areas at the surface, rises in low-pressure areas, and returns aloft. Again, other forces-the effects of the earth's rotation, centrifugal force, and friction-complicate this pattern, but we will postpone our detailed consideration of these forces until later chapters. Here it is sufficient to point out that motion in the atmosphere takes place on various scales-from the hemi-

spheric motion of the general circulation, through intermediate-scale motion involving broad high- and low-pressure areas, through smaller and smaller circulations, to small eddy motion.

Atmospheric Stability

Vertical motion in the atmosphere encounters resistance because of the temperature or density structure of the atmosphere. In fact, we can define **atmospheric stability** as the resistance of the atmosphere to vertical motion. We have already learned the two basic concepts necessary to understand atmospheric stability -first, that pressure in the atmosphere decreases with height, and second, that the temperature of a small mass or parcel of air decreases as the air expands, provided no heat is added to the parcel. The converse of these concepts is also true.

Rising air encounters lower pressures in the surrounding air, permitting it to expand. The energy required for expansion comes from the heat energy in the rising air. Consequently,

the temperature of the rising air lowers. Descending air, by the reverse process, is compressed and warmed. If no heat is gained or lost by mixing with the surrounding air, this is an adiabatic process. In the **adiabatic** lifting process, unsaturated air-cools at the fixed rate of approximately 5.5°F. per 1,000 feet increase in altitude. This is the **dry-adiabatic** lapse rate. Unsaturated air brought downward adiabatically warms at the same rate.

If a lifted parcel of air, which has cooled at the **dry-adiabatic rate**, becomes immersed in warmer, less dense air, it will fall to its original level or to the level at which it has the same temperature as the surrounding air. Similarly, if the parcel is lowered and is then surrounded by cooler, more dense air, it will rise to its original level. The surrounding atmosphere is then **stable**. If a parcel, moved up or down in the atmosphere, tends to remain at its new level, the atmosphere is **neutral**. If a parcel, moved up or down, tends to continue to rise or fall of its own accord, the atmosphere is **unstable**.

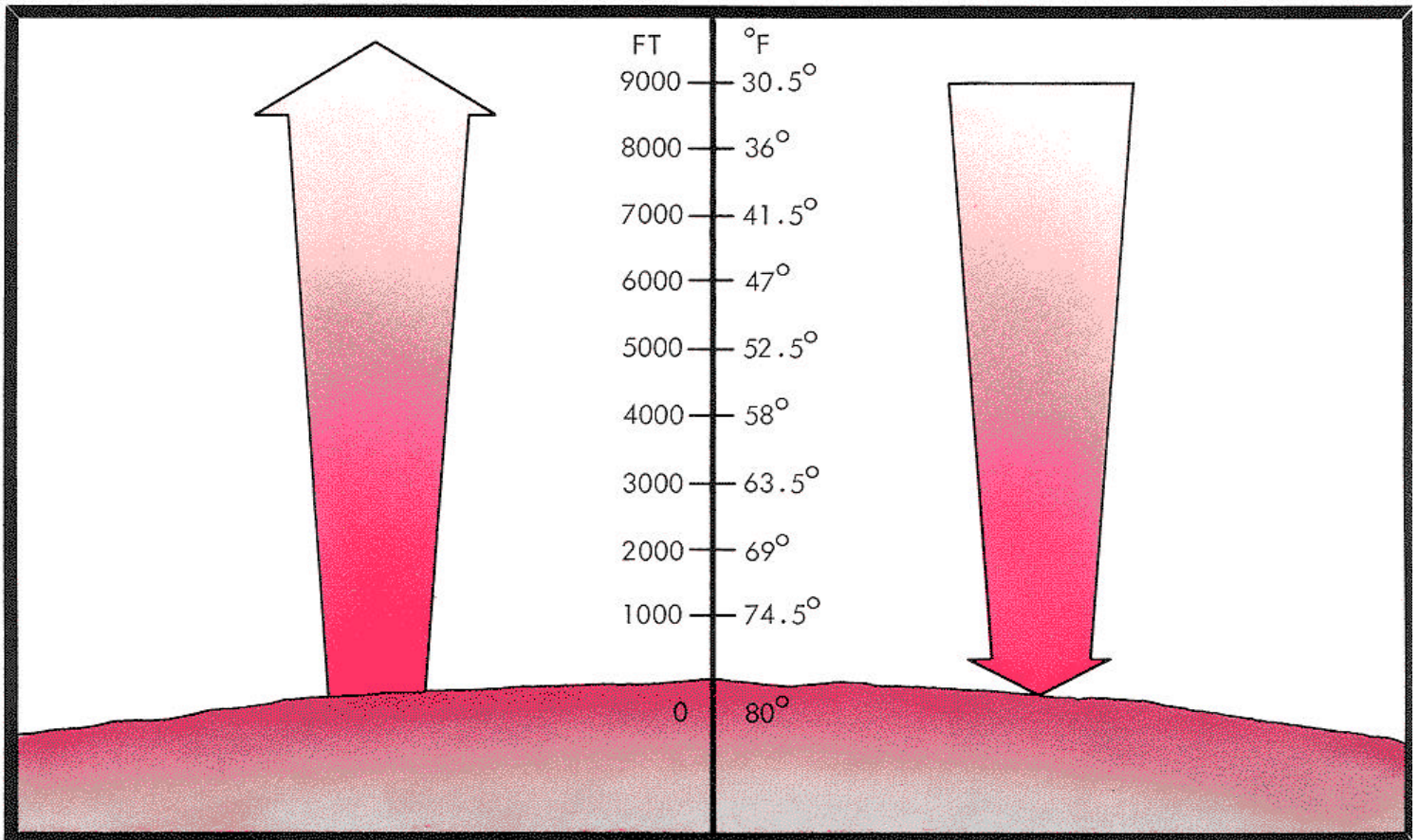

Rising air expands and cools. Sinking air is compressed and warmed. If no heat is gained or lost by mixing with surrounding air, this is an adiabatic process.

Atmospheric stability can be determined from the measured rate of temperature change with change in height in the free air, called the **environmental lapse rate**. A change of 5.5°F. per 1,000 feet indicates a neutrally stable atmosphere. A parcel of dry air moved up or down is then at exactly the same temperature as the surrounding air. If the environmental lapse rate is less than 5.5°F. per 1,000 feet, the atmosphere is stable with respect to unsaturated air. In such an atmosphere, a parcel of air moved up (or down) would be colder (or warmer) than the surrounding air and would tend to return to its original level. A layer of air in which the temperature increases with height is an extremely stable layer. Such a layer is called an **inversion**. If the environmental lapse rate is greater than 5.5°F. per 1,000 feet, an unsaturated atmosphere is unstable. A raised (or lowered) parcel of air would then be warmer (or colder) than its surroundings and would continue its vertical movement.

A similar process applies to an air parcel that has been cooled enough to condense part of its water vapor. In this case, the rate of temperature change of the parcel is less than the dry-adiabatic rate because of the addition of the **latent heat of vaporization**. This rate varies according to the amount of water vapor in the parcel and is usually between 2°F. and 5°F. per 1,000 feet. This is the **moist-adiabatic rate**. The surrounding atmosphere is then judged to be stable, neutral, or unstable by comparing its lapse rate with the moist-adiabatic rate.

Moisture in the atmosphere, clouds, precipitation, and many other weather phenomena are directly related to these adiabatic responses of air to lifting and sinking.

With the background of this chapter, we are now ready to consider more thoroughly some of the static properties of the atmosphere, such as temperature and humidity, and then we will consider the dynamic weather processes.

Chapter 2

TEMPERATURE

Temperature of forest fuels, and of the air around and above them, is one of the key factors in determining how wildland fires start and spread. Temperature directly affects the flammability of forest fuels, since the amount of heat required to raise the temperature of the fuels to the ignition point depends on their initial temperature and that of the surrounding air.

Temperature indirectly affects the ways fires burn, through, its influence on other factors that control fire spread and rate of combustion (e.g., wind, fuel moisture, and atmospheric stability). An understanding of local temperature variations is the first step toward a better understanding of almost every aspect of fire behavior.

TEMPERATURE

Temperature was defined in chapter 1 as the degree of hotness or coldness of a substance. We also learned there that the atmosphere is warmed only slightly by direct, mainly short-wave, solar radiation. Most of the warming takes place by conduction and convection from the heated surface of the earth and from long-wave radiation from the surface.

We will see later that temperature has far-reaching effects on general atmospheric circulation, the formation and movement of air masses, and regional weather patterns. These are all important to fire weather. But in fire weather, we are also concerned **with smaller scale patterns-those** that change from hour to hour, from one slope facet to another, from one forest type to another, from a closed canopy to a forest opening, etc. In these patterns, temperature variations also are often the

controlling factor.

Large-scale weather patterns are commonly identified by sampling the weather at regular weather observation stations. Small-scale patterns and their variations, however, cannot be defined from measurements made at the usually widely spaced fixed stations. Sometimes portable instruments permit satisfactory measurements, but more frequently local variations must be identified by judgment based on personal knowledge of the detailed ways in which heating and cooling of surface materials and the air around them takes place, and on how thermal energy is transferred between the earth's surface and the lower air.

In this chapter, we will consider variations in surface and air temperatures and why they occur.

MEASURING TEMPERATURE

Fahrenheit, Celsius

We measure temperature in degrees on arbitrary scales based on fixed reference points. On the **Fahrenheit** scale, which is commonly used in the United States, the melting point of ice is 32°F. and the boiling point of water is 212°F. under standard sea-level pressure, a difference of 180 Fahrenheit degrees. Upper-air temperatures are commonly reported on the Celsius scale. This scale is also used in most scientific work around the world. On this scale the melting point of ice is 0°C. and the boiling point of water is 100°C., a difference of 100-Celsius degrees. Thus, 1 degree C. is equal to 1.8°F., a ratio of 5 to 9. °C. is converted to °F. by multiplying by 1.8 and adding 32.

The operation of common thermometers is based on the expansion and contraction of substances when heated or cooled. In the familiar mercury or alcohol thermometers, the liquid from a small reservoir expands into a long column with a very small inside diameter. Thus,

the expansion is sufficiently magnified so it can be accurately scaled in terms of actual temperature change.

A thermometer embedded in a solid or immersed in a liquid soon comes to a temperature equilibrium with the substance, and shows the actual temperature of the substance. Measuring the air temperature is a bit more difficult. During the day, for example, if sunlight strikes the bulb of the thermometer, the reading will be higher than the air temperature because of direct radiation. At night, if the bulb is exposed to the sky, the reading will be influenced by the outgoing radiation from the bulb, and will be lower than the air temperature. To avoid this difficulty, thermometers are usually shielded from radiation so that the exchange of heat between the thermometer and the air is restricted as much as possible to conduction. A standard instrument shelter provides this shielding at fixed locations while still permitting free flow of air past the thermometer in

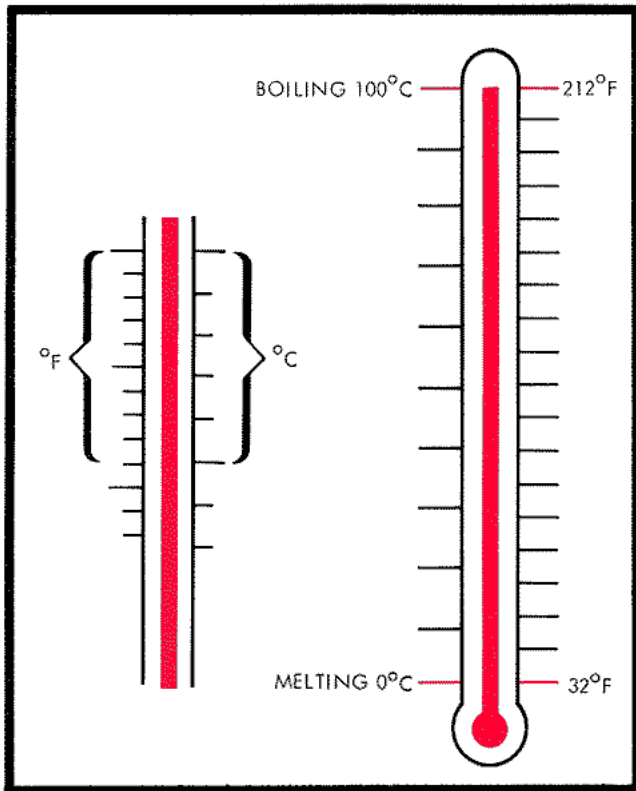

The two common temperature scales in use are Fahrenheit and Celsius. Nine degrees Fahrenheit equals five degrees Celsius.

side. A hand-held thermometer should be kept shaded and should be swung rapidly for a few seconds to insure a comparable reading.

Representative Measurements

The measured air temperature at a fire-weather station, to be most useful in fire control, should be representative of the surrounding conditions. Many factors, as we will see, affect the air temperature; these include the type of ground surface, nearby buildings or trees, the local topography, and the height above the ground.

EARTH SURFACE TEMPERATURES

Effects of Factors Affecting Solar Radiation

The temperature of the surface of most materials comprising the surface of the earth, except water and ice, has a greater range than does that of air. The temperature of surface materials is important because the air is primarily

certain standards of thermometer exposure have been established so that temperature readings at one weather station may be compared to those at another. Measurements are made at a standard height of 4 1/2 feet above the ground. Locations near buildings or other obstructions are avoided, as are types of ground surfaces such as concrete or asphalt, which would obviously affect temperature readings. Purely local effects are avoided where possible.

The local variations in temperature that are avoided when readings are used for fire-weather forecasting or for area fire-danger rating become most important when judgments must be made concerning fire behavior at a particular time and place. Then it is necessary either to take closely spaced measurements to show the temperature variations, or to make judgments based on personal knowledge of where and how these variations might occur.

The causes of these temperature changes are many and varied. However, three important processes underlie all causes: (1) Heating and cooling of the earth's surface by radiation, (2) exchanging of heat between the surface and the air above it, and (3) conversion of thermal energy in the atmosphere to other forms of energy, and vice versa. All three processes vary continuously.

In the process of warming and cooling, heat is exchanged between the earth's surface and the atmosphere. Some of the heat transferred to the atmosphere is transformed to potential and kinetic energy, and becomes the driving force of weather processes. To understand these processes, and the resulting temperature variations, let us first consider surface temperatures and then consider air temperatures.

heated and cooled by contact with heated or cooled surfaces.

Some factors affect surface temperatures by influencing the amount of solar radiation that strikes the surface or by trapping the earth's radiation. We have considered some of these factors in chapter 1.

A lower sun angle results in the reception of less solar radiation per unit area and a lower surface temperature. More hours of daylight mean more heating and higher surface temperatures. Conversely, more hours of darkness result in more cooling and lower surface temperatures,

Topography plays an important role in local surface temperature variations. Differences in topography cause local variations in the angle at which the sun's radiation strikes the ground surface. Both the steepness and the aspect of a slope affect surface heating and cooling. Surfaces more nearly perpendicular to incoming radiation receive more heat per unit area than do those more nearly parallel to incoming radiation. As the sun moves across the sky, its rays are more nearly perpendicular to different slopes and aspects at various hours. South-facing slopes, which in the Northern Hemisphere receive more nearly direct rays from the sun during most of the day than do north-facing slopes, may have a surface temperature in midsummer as high as 175°F.

Level surfaces reach their maximum temperatures around noon, but the maximum temperature on a slope depends upon both the inclination and orientation of the slope and on the time of day. Accordingly, east-facing slopes reach their maximum temperature rather early in the day; west-facing slopes attain their maximum temperatures later in the afternoon. In general, the highest surface temperatures are found on slopes facing to the southwest.

Shading and scattering by any means, such as clouds, smoke or haze in the air, and objects such as trees, reduce the solar radiation reaching the ground surface. In hilly or mountainous regions, higher ridges shield lower elevation surfaces from incoming radiation, and actually reduce the hours of sunshine. All vegetation creates some shade, but the variations in type and density cause local differences in surface temperatures. In open stands of timber, shaded and unshaded areas change temperature throughout the day according to the position

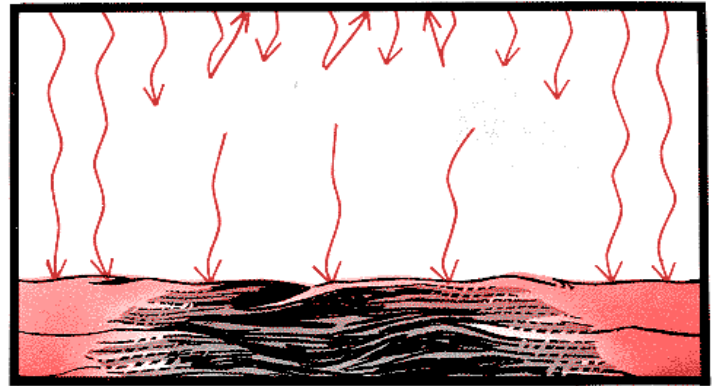
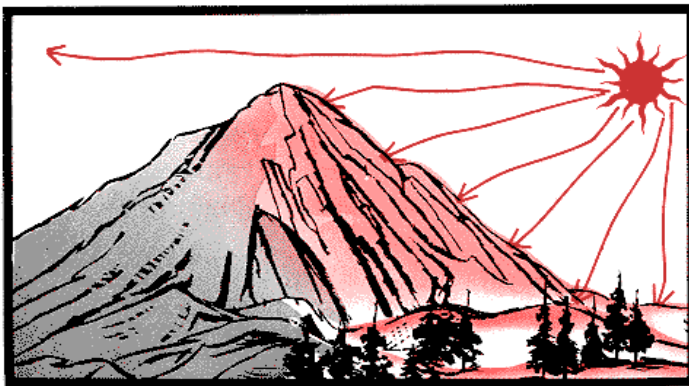
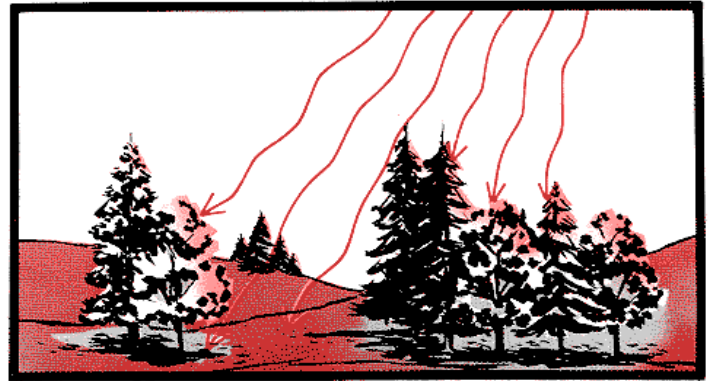
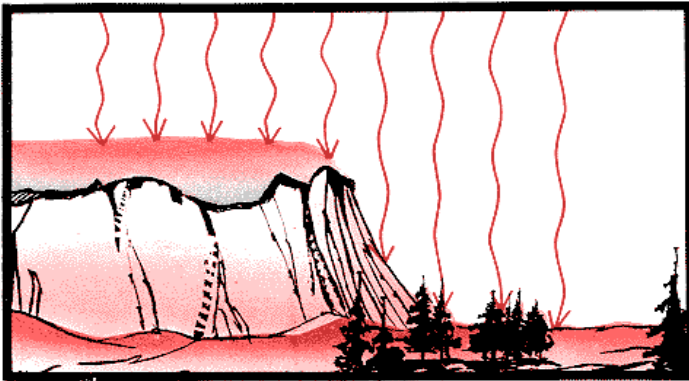

Upper Left. – Surfaces more nearly perpendicular to incoming radiation receive more heat per unit area, and become warmer, than do those more nearly parallel to the incoming radiation. Lower Left. – As the sun arcs across the sky, its rays are more nearly perpendicular to different slopes and aspects at various

hours. South-facing slopes receive more nearly direct rays than do north-facing slopes. Upper Right. – In open stands of timber, surface temperatures vary considerably from shaded to sunlit areas. Lower Right. – Clouds both absorb and reflect incoming radiation and thereby reduce surface temperatures.

of the sun. Surface temperatures respond quickly to these changes. For example, a forest floor with a mottled sun and shade pattern may have temperature variations during the summer of as much as 50-60°F. within a few feet. In deciduous forests in the winter, there will be a fair degree of uniformity of ground temperature. In open pine forests, marked differences in ground temperature are noted both in summer and winter.

Both liquid water droplets in clouds and the water vapor in the atmosphere directly affect surface temperatures. They both absorb some incoming radiation, and clouds reflect much of the solar radiation. The thicker and lower the clouds, the less incoming radiation strikes the surface. The surface temperature may drop as much as 50°F. within 3 minutes as a thick cloud passes overhead in clear midsummer weather. Water droplets in clouds, and invisible water vapor in the air, also influence the cooling of the surface at night. Both absorb much of the outgoing thermal radiation, and some of this heat is reradiated back to the earth. Thus, surface temperatures normally are much lower on clear nights than on cloudy nights. The lack of water vapor in the air is one reason why surface temperatures in the desert become so low at night.

A blanket of smoke from forest fires, like clouds, causes significantly lower daytime surface temperatures, and higher nighttime temperatures, when skies are otherwise clear.

Effects of Surface Properties

However, even when a certain amount of radiation strikes a surface, there are several properties of the substance itself, which affect its resulting temperature.

First is the **capacity of the substance to absorb or reflect radiation**. Dark materials generally absorb most of the radiation in the visible wavelengths, whereas light materials reflect most of this radiation back to space. Since dark soils and forest litter are rather good absorbers and poor reflectors of radiation, they will become hotter than light-colored soils. Dark pavements will become quite hot on sunny days. The temperature of the tree crown in a forest will rise also, but not as much. Some of the incoming radiation is used in processes other than heating, such as in the production of food and in the vaporization of the moisture released by transpiration. Substances

that are good radiators of long-wave radiation emit heat rapidly from their surfaces at night when exposed to a clear sky. If they are not supplied with heat from within, these surfaces become quite cold at night. Tree crowns, grass, plowed land, and sand are all good radiators.

The **absorptivity** and **emissivity** of a surface both vary with the wavelength of the radiation and the temperature. But under identical wavelengths and temperature, absorptivity and emissivity are assumed to be the same.

Snow is an interesting substance in that its properties are very different at different wavelengths. In the visible portion of the spectrum, snow will reflect 80 to 85 percent of the incoming short-wave radiation. This accounts for its white color. For long-wave radiation, however, snow is an extremely good absorber and a near perfect radiator. Therefore, a snow surface heats up little during the day, but cools by radiation extremely well at night. We will see later that these characteristics make snow ideal for the formation of cold, dry air masses.

A second property of surface materials affecting temperature is **transparency**. Water is fairly transparent to incoming radiation, while opaque materials are not. The heat absorbed by opaque substances is concentrated in a shallow surface layer, at least initially. But radiation penetrates deeply into water, heating a larger volume. This is one reason why opaque substances such as land become warmer during the day than water does. However, it is not the most important reason. The downward mixing of warmed surface water by turbulent motion is more important in distributing the incoming heat through a large volume.

A third property is the **conductivity** of the substance. Incoming radiant energy striking a good conductor, such as metal, is rapidly transmitted as heat through the material, raising the temperature of the metal to a uniform level. The same radiant energy applied to a poor conductor tends to concentrate heat near the surface, raising the surface temperature higher than that in the interior. Wood, for example, is a poor conductor, and heat applied to it concentrates at the surface and only slowly penetrates to warm the interior. Leaf litter is an

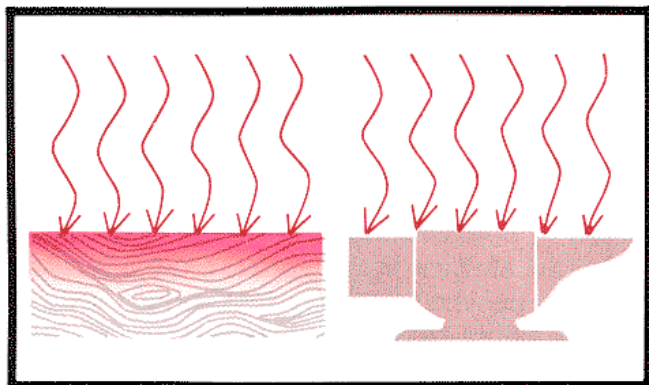
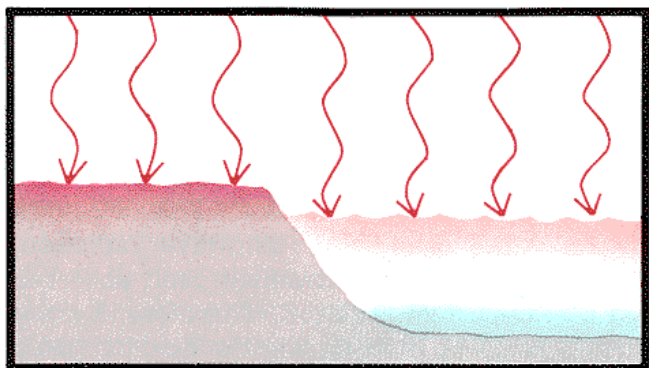
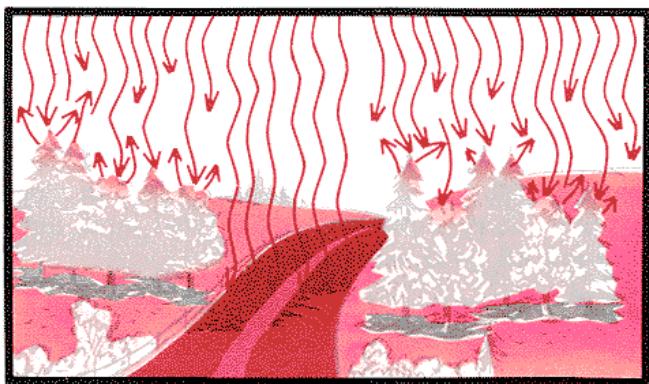

Air is a very poor conductor, so porous substances such as duff or litter with many air-spaces will bar the passage of surface heat to the soil below. At night, as surfaces cool by radiation, the surfaces of good conductors do not cool as fast as those of poor conductors so long as there is heat below to replenish that lost at the surface by radiation. A weathered board, for example, lying on bare ground in the open may have frost on it, whereas none has formed on the nearby ground.

To summarize, the surfaces of poor conductors get hotter during the day and cooler at night than the surfaces of good conductors.

We learned in chapter 1 that different substances have different heat capacities, and that the specific heat of a substance is the ratio of its heat capacity to that of water. The specific heat, then, is another reason why the surface temperature of substances vary under similar conditions of incoming and outgoing radiation. A substance with a low specific heat will warm up rapidly as heat is added to it, simply because it takes less heat to change its temperature. Water has a high specific heat, and its temperature changes 1°F. when 1 B.t.u. of heat energy per pound is gained or lost. Wood, which has about half the specific heat of water, changes about 2°F. with a change of 1 B.t.u. per pound. Materials like charcoal, ashes, sand, clay, and stone change about 5°F. Litter surfaces composed of dry leaves, needles, and grass have low heat capacities, and, as mentioned above, are also poor heat conductors. For these two reasons, direct solar radiation often heats litter surfaces to temperatures far above the temperature of the overlying air without heating the soil below,

Since water has a high specific heat and is a fairly good conductor, the surface temperatures of substances are greatly influenced by the presence of moisture. Moist surfaces, when compared with dry surfaces, will not reach as high temperatures in the day or as low temperatures at night. This is another reason why and semiarid areas, when compared with moist regions, have both higher daytime surface temperatures and lower nighttime surface temperatures.

The presence of moisture is also important because of the heat used in evaporation and re-

Top – Surface materials differ in their absorptive and reflective properties. Dark pavements become quite hot in sunlight; dark soils become warmer than light soils. The temperature of tree crowns will rise also, but not as much. **Center** – Heat absorbed by opaque substances, such as land, is concentrated in a shallow layer. Radiation penetrates deeply into water and warms a larger volume. **Bottom** – Radiant energy absorbed by a good conductor, such as metal, is rapidly transmitted through the material, while that absorbed by a poor conductor, such as wood, tends to concentrate near the surface, and the surface becomes quite hot.

other poor conductor. Common rocks, damp soil, and water, although not as efficient conductors of heat as metals, are much better conductors than wood, other organic fuels, or dry soils.

leased in condensation. We have seen that while 1 B.t.u. will raise the temperature of 1 pound of water 1°F., nearly 1,000 are required to evaporate 1 pound of water under normal conditions of pressure and temperature. Thus when water is evaporated from a surface, cooling takes place at the surface with a corresponding reduction in the surface temperature. This, then, is another reason why surfaces of moist substances have lower daytime temperatures than dry substances. At night, if vapor condenses, an equally large amount of heat is liberated to warm the surface.

Effect of Wind

Strong daytime winds near the surface tend to prevent high surface temperatures. Transfer of heat between the surface and the air is improved by mixing, which carries heat away from the heated surfaces. This air movement also transports moisture, increasing evaporation from moist surfaces and thus restricting the temperature rise. At night the effect of strong winds is to prevent low surface temperatures by mixing warmer air downward and bringing it into contact with the surface, where some of the heat can be transferred to the ground by conduction. Thus, windiness has a moderating influence on surface temperatures.

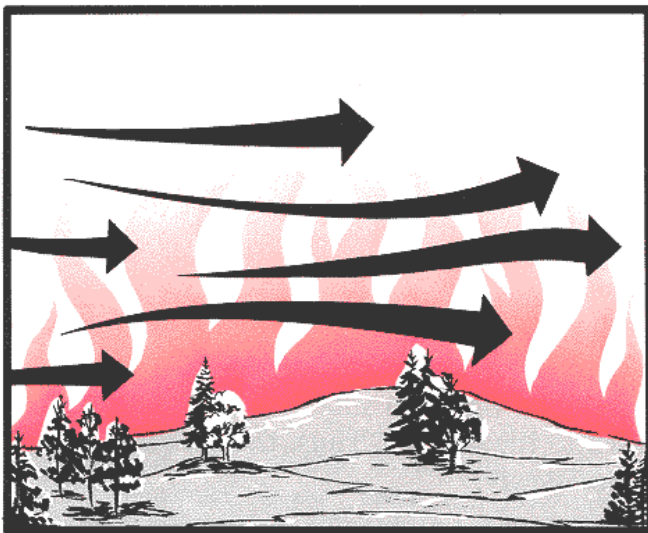

Strong daytime winds cause turbulent, mixing, which carries heat away from warmed surfaces and lowers surface temperatures.



In a stable air mass, the daytime heating and mixing are confined to a shallow layer, and the temperature of this air will increase rapidly.

AIR TEMPERATURES

The exchange of heat between the air and the surfaces over which it flows is the master controller of air temperatures. This exchange is a continuous process, taking place everywhere at all times. When a large body of air comes to rest or moves very slowly over a land or sea area having uniform temperature and moisture properties, such as the oceans or the polar regions, it gradually takes on the temperature and moisture characteristics of the underlying surface. Then, when the body of air, called an air mass, moves away from this region, it tends to retain these characteristics, although slow modification takes place during its travel.

The **air-mass temperatures** impose some restraint on the daily heating and cooling that the air mass encounters. For example, under the same conditions of daytime heating, a cold air mass will not reach as high a temperature

as a warm air mass. We will now consider how local changes in air temperatures are produced within the limitations of the air-mass temperature.

How Air is Heated

Incoming solar radiation heats the air directly only 0.5-1°F. per day, depending mostly on the amount of water vapor present. The rest of the heating comes from below, most of it by conduction, through direct contact with the warmed surface of the earth. The heated surface air becomes buoyant and is forced upward by cooler, more dense air. This convection may distribute the heat through a depth of several thousand feet during the day.

The final depth through which heat from the surface is distributed through the atmosphere will be affected by the **lapse rate** of the air. If the lapse rate is stable through a deep layer, the daytime mixing and heating of the atmosphere will be confined to a fairly shallow

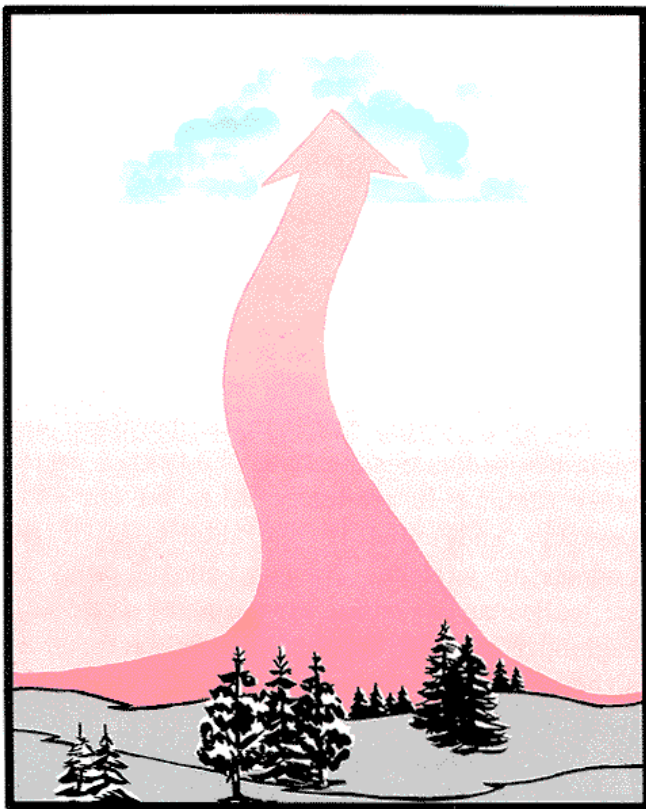

In a relatively unstable air mass, heating and mixing will take place throughout a deep layer, and the air temperature near the ground will rise slowly and to a smaller extent.

layer of perhaps 1,000 to 2,000 feet, and the temperature of this layer will increase rapidly. If, through a layer of air several thousand feet deep, the temperature lapse rate approaches the dry-adiabatic rate, heated air parcels will be carried to much greater heights. Then the heating and mixing take place throughout a deep layer, and the rise in air temperature near the ground will be less and slower. Thus, we can see that the characteristic air-mass temperature at several thousand feet above the surface is important in estimating the maximum temperature of air near the surface.

The effect of wind on heating of the air is similar to that of stability. Strong winds cause more turbulence and mixing so that heat is distributed through a deeper layer and the temperature rise of air near the surface is less. The greatest temperature rises resulting from surface heating occur with light winds.

Another factor in the heating of the air near the surface that we should not overlook is the absorption of the earth's long-wave radiation by water vapor. Since most of the water vapor is concentrated in the lower layers of the atmosphere, these lower layers are heated by absorption of earth radiation as well as by conduction and convection.

How Air is Cooled

Air-cools at night by the same heat transfer processes-conduction, radiation, and convection-as it heats during the day. The surface begins to cool first by radiation, cooling the air in contact with it. On clear, calm nights this is the primary method of cooling. It is primarily the surface air layer, which is cooled while the air aloft may remain near day temperatures.

Water vapor and clouds also lose heat to the sky by their own radiation, but at a slower rate than the heat lost near the surface through clear, dry air. When clouds or significant water vapor is present, much of the outgoing radiation from below is intercepted and reradiated back to the surface. Thus, the surface is cooled more slowly.

Winds at night also reduce the cooling of surface air by bringing down and mixing warmer air from above. This process does not

slow the surface radioactive cooling, but it does spread its effects on air temperature through a deeper layer. On the average, however, the dif-

ference between day and night air temperatures is much greater near the surface than it is aloft.

VERTICAL VARIATION OF AIR TEMPERATURE

We have seen that the atmosphere is heated from below by conduction and convection. We also know that the gases and substances with good heat-absorbing properties, such as water vapor, liquid water, smoke, and dust, are more concentrated in the lower levels of the atmosphere. At higher levels in the atmosphere, heat is lost to space by radiation. We should expect, therefore, that the temperature of the atmosphere decreases with height. We generally find this situation when we measure air temperatures aloft. Such measurements are made by instruments, attached to balloons, that transmit signals electrically to receivers on the ground. Another reason for the decrease of temperature with height is that air expands and becomes cooler as it is moved up, and as air is moved down it is compressed and becomes warmer.

The year-round average rate of temperature decrease with height in the troposphere at 45° N. latitude, as determined from many hundreds of measurements or soundings, is 3.5°F. per 1,000 feet. In any altitudinal range in the troposphere at any time, however, the lapse rate may deviate significantly from this average. The atmosphere is often stratified as a result of horizontal motion aloft. Each stratum may have its individual temperature structure. Inversions aloft, though less common than at the surface, are caused by the inflow of warm air above, or by subsidence in large high-pressure systems.

In the lowest layers of the atmosphere, the change of temperature with height varies considerably from day to night. Early in the morning, heating begins at the surface, warming air in a very shallow layer. The warm air is forced upward, but only to the level where its temperature is equal to that of the surrounding air. The warmed layer becomes gradually deeper with additional heating, eliminates the night inversion, and reaches its maximum temperature about mid-afternoon.

On days with strong surface heating, air next to the ground can become quite hot. At the surface the temperature may be 150°F, while at the shelter height (4 1/2 feet) it may be only 90°F. Such changes in temperature with height far exceed the dry-adiabatic lapse rate. A lapse rate that exceeds the dry-adiabatic is called a **superadiabatic**, lapse rate. Under extreme conditions such a lapse rate may extend to 1,000 feet, but normally it is confined to the first few hundred feet. Superadiabatic lapse rates are conducive to convection and vertical mixing. Local winds may be quite gusty. As mixing continues, the superadiabatic lapse rate tends to change toward the dry-adiabatic. Therefore, strong superadiabatic conditions persist during times when excessive heat is continually supplied to the surface. They develop most readily with clear skies and light winds, and over surfaces with the highest temperatures, such as dark soils and surface materials, particularly burned-out and blackened areas.

Often under calm conditions, and especially over flat terrain, heated air parcels do not rise

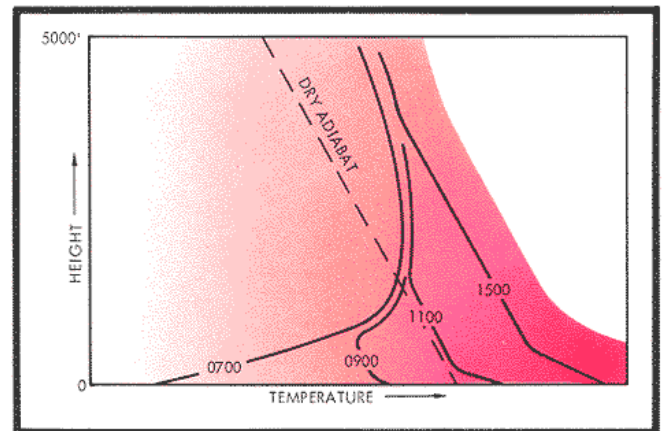

Successive plots of temperature against height on a clear day show that early in the morning a shallow layer of air is heated, and gradually the warmed layer becomes deeper and deeper, reaching its maximum depth about mid-afternoon.

immediately. They have inertia and remain on the surface until some disturbance permits cooler surrounding air to flow in beneath and provide the needed buoyancy. This disturbance might be a sudden gust of wind or some other mechanical force. Dust devils and small whirlwinds are common indicators of this buildup and escape of hot surface air.

Marine Inversion

A common type of warm-season inversion, found particularly along the west coast, is the **coastal or marine inversion**. Here cool, moist air from the ocean spreads over low-lying land. The layer of cool, moist air may vary in depth from a few hundred to several thousand feet. This layer is topped by a much warmer, drier, and relatively unstable air mass. Marine inversions, although they may persist in some areas during the day, are strongest and most noticeable at night. Fog and stratus clouds often form in the cool marine air at night and move inland into coastal basins and valleys. If the cold air is quite shallow, fog usually forms. If the layer is deep, stratus clouds are likely to form.

Night Inversions

Air cooled at night, primarily by contact with cold, radiating surfaces, gradually deepens

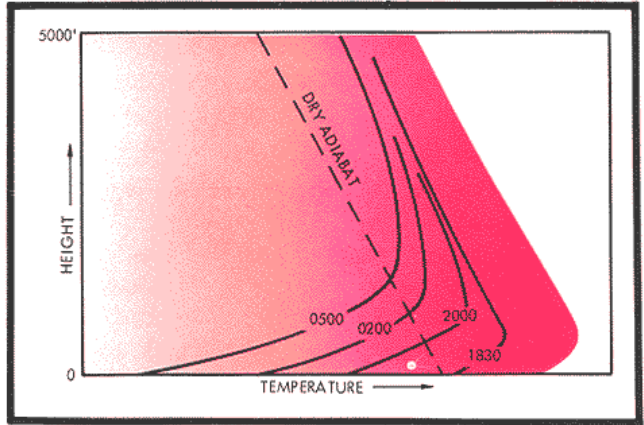

Plots of temperature against height during the night hours show that the air is first cooled next to the ground, forming a weak surface inversion. Then, as cooling continues during the night, the layer of cooled air gradually deepens, causing the inversion to become deeper and stronger.

as the night progresses and forms a **surface inversion**. This is a surface layer in which the temperature increases with height. Such an inversion may involve a temperature change of as much as 25°F. in 250 vertical feet. The cold air is dense and readily flows down slopes and gathers in pockets and valleys. Surface inversions forming at night are commonly referred to as **night inversions**. Night inversions are so important in fire behavior that we should consider them in some detail.

Night inversions are common during clear, calm, settled weather. They are usually easy to identify. Inversions trap impurities, smoke, and factory and traffic fumes, resulting in poor visibility. Smoke from chimneys rises until its temperature matches that of the surrounding air. Then it flattens out and spreads horizontally. If fog forms in the cold air, it is generally shallow ground fog, its depth generally less than that of the inversion. Ground fog in patches in surface depressions along highways is formed in small-scale inversions.

Cloudiness and water vapor in the atmosphere limit the formation and strength of night inversions by reducing the rate of outgoing radiation from the earth.

On windy nights, compared with calm nights, turbulence and mixing distribute the cooling through a deeper layer, and the temperature decrease is less. Winds may reduce and sometimes prevent the formation of a night inversion. The drop in temperature near the

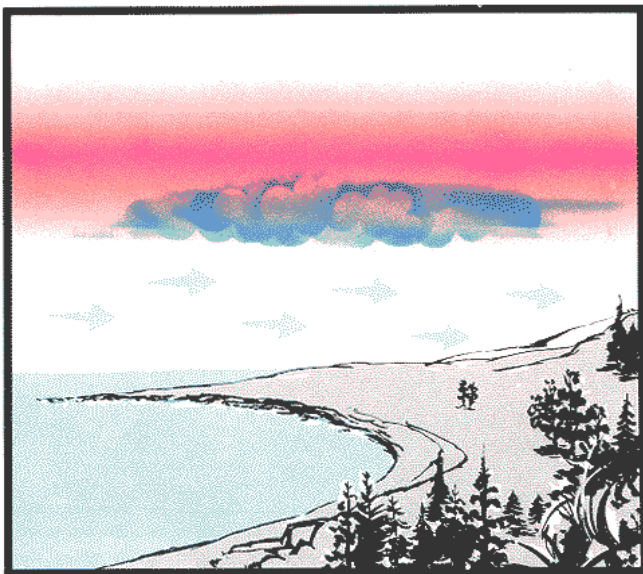

Cool, moist air from the ocean spreads over nearby low-lying land areas beneath the marine inversion.



Smoke released into an inversion layer will rise only until its temperature equals that of the surrounding air; then the smoke flattens out and spreads horizontally.

ground at night is thereby often abruptly stopped or even reversed when the wind picks up.

Night inversions are shallow but more intense when the overall temperature structure of the atmosphere is stable. Under unstable conditions, convection distributes available heat. Inversions are therefore less likely, and those occurring will not be as intense. However, if a night inversion is able to form, mixing is reduced in the lower layers.

Topography plays a decided role in both the formation and intensity of night inversions. Cold air layers are quite shallow on slopes and in open canyons or ravines where the cold, dense air can drain away as it is formed. This descent of cold air results in the formation of deep, cold layers and inversions in valleys. Inversion layers are both more common and intense in lower mountain valleys or in basins with poor air drainage, than in flat areas.

In mountainous areas, the height of the top of night inversions, although it varies from night to night, is usually below the main ridges. The height of the warmest air temperature at the inversion top can be found by measuring temperatures along the slope. From this level, the temperatures decrease as one goes farther up or down the slope. At this level are both the highest minimum temperatures and the least

daily temperature variation of any level along the slope. Here also are the lowest nighttime relative humidity and the lowest nighttime fuel moisture. Because of these characteristics of the average level of the inversion top, it is known as the **thermal belt**. Within the thermal belt, wildfires can remain quite active during the night. Below the thermal belt, fires are in cool, humid, and stable air, often with down slope winds. Above the thermal belt, temperatures decrease with height. The effect of the lower temperatures, however, may be offset by stronger winds and less stable air as fires penetrate the region above the thermal belt.

Night inversions in mountainous country increase in depth during the night. They form early in the evening at the canyon bottom or valley floor and at first are quite shallow. Then the cold layer gradually deepens, the top reaching farther up the slope with the continued cooling from the surface and the flow of cold air from adjoining slopes. A maximum depth is reached during the middle of the night, and the depth may then remain constant or decrease slightly just before sunrise. If the air is sufficiently cold and moist, fog may form.

After sunrise, surface heating begins to warm the cold air, and the inversion top may actually rise slightly from this expansion. As heating destroys the inversion along the slopes,

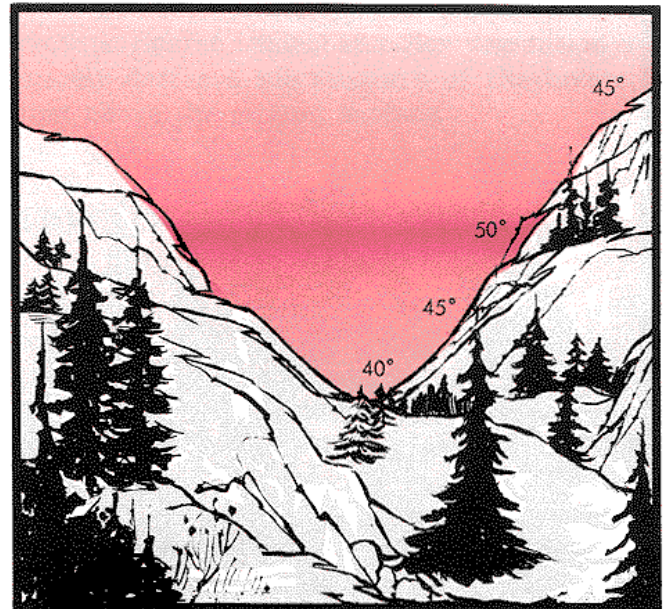

The zone of warm nighttime temperatures near the top of the inversion is known as the thermal belt.

upslope winds begin. The transport of air from the valley bottom up the slopes may actually cause the inversion top to lower over the middle of the valley. Finally, with continued

heating and mixing, the inversion layer is completely dissipated. **The behavior of a fire burning beneath an inversion may change abruptly when the inversion is destroyed.**

EFFECTS OF FORESTS ON TEMPERATURE NEAR THE GROUND

In all situations, vegetation moderates air temperatures within the vegetative layer for several reasons. **First**, it intercepts both incoming and outgoing radiation and therefore has a marked effect on ground temperature; second, green foliage does not warm up as much as ground or dry litter; and **third**, leaf surfaces exchange heat with air through a deeper, less restricted boundary layer. These effects result in less pronounced temperature changes with height above the ground.

In all vegetative cover, the temperature distribution depends upon the nature and density of the vegetation. With plants, such as low brush, the leaves form a nearly continuous upper surface, and this surface acts as the effective ground surface. The maximum daytime temperatures and minimum nighttime temperatures are near the top of the brush or dense plant cover, although temperatures near

the ground are not greatly different.

The crowns of trees in a heavy forest form a nearly continuous cover and the canopy thus becomes, in effect, the air contact surface. The highest daytime temperatures are found near the crown top, and the temperature will decrease gradually between this level and the ground. Maximum air temperatures near the crowns may be 180 to 200 warmer than air temperature near the ground. Above the tree crowns the temperature decreases fairly rapidly with height, although never as rapidly as over bare ground. This is because the temperatures of the tree crown surfaces in contact with the air are lower than bare ground, and because the air circulation around these surfaces is better.

Less dense vegetation will permit more solar radiation to penetrate to the ground than will a dense cover. The degree of partial ground



Crowns of trees in a heavy forest become the effective air contact surface. Air in the crown region had higher daytime temperatures than air beneath the crowns.



Nighttime temperatures in a dense timber stand tend to be lowest near the tops of the crowns, where the principal radiation takes place.

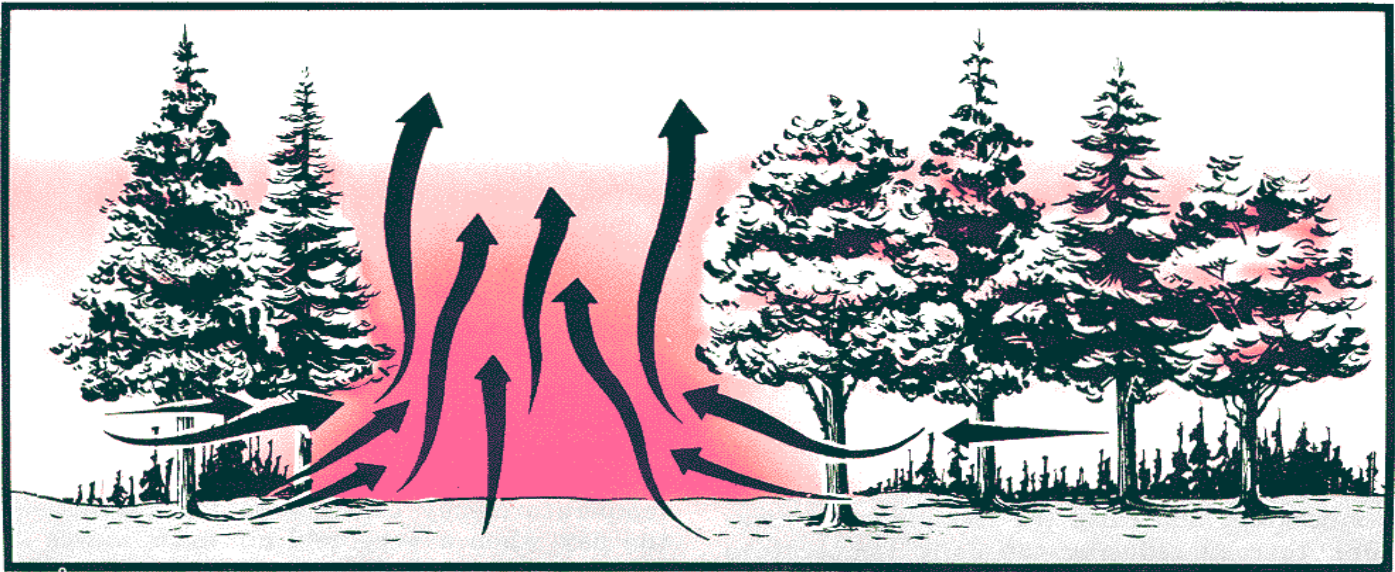

Openings in a timber stand tend to act as chimneys under conditions of strong daytime heating and light winds.

shading provided by less dense vegetation determines; the air temperature distribution between the ground surface and the canopy top. It will range between that found over bare ground and that under a closed canopy.

Air temperatures at the standard 4 1/2-foot height within the forest in the afternoon are likely to be 5° to 8° cooler than the temperatures in nearby cleared areas. Openings in a moderate to dense timber stand may become warm air pockets during the day. These openings often act as natural chimneys and may

accelerate the rate of burning of surface fires, which are close enough to be influenced by these "chimneys."

Night temperatures in dense timber stands tend to be lowest near the top of the crown where the principal radiation takes place. Some cool air from the crowns sinks down to the ground surface, and there is some additional cooling at the surface by radiation to the cooling crowns. Sparse timber or other vegetation will merely decrease the strength of the inversion just above the ground surface.

SEASONAL AND DIURNAL VARIATIONS IN AIR TEMPERATURE

Seasonal temperature patterns are affected principally by **latitude**, **large water bodies**, and the general **circulation patterns**. The latitude effect is, as we have seen, due to the angle at which the sun's rays strike the earth. In general, the seasonal variation of temperatures near the surface is least in equatorial regions, where there is little difference in solar heating through the year. This seasonal variation increases with latitude to both polar regions, where summer days have a maximum of 24 hours of sunshine and winter days a maximum

of 24 hours of darkness. Large water bodies moderate the seasonal temperature cycle because of their great heat capacity. In one area, the general circulation pattern may produce cloudy weather with successive influxes of cold air, and thus a reduction in the monthly or seasonal temperature. In another area, the same pattern may produce opposite effects.

The diurnal temperature variation depends upon all of the factors we have discussed so far. The normal daily pattern at an inland location with level terrain consists of a daily temperature

range of 20-30°F. near the surface, with the highest temperature in mid afternoon and the lowest temperature just after sunrise. The reason for this lag in maximum and minimum temperature was discussed in chapter 1. This diurnal temperature range decreases with altitude above the surface. Various factors alter this pattern.

A primary factor is the character of the surface. In general, those surfaces that become warmest during the day also become coldest at night, and the air temperature above them also has a high daily range. Snow surfaces are an important exception.

Clouds, strong winds, high humidity, and atmospheric instability lower the maximum temperature and raise the minimum temperature, thereby reducing the daily temperature range.

In mountainous terrain, one finds a greater diurnal variation in temperature in the valleys, and less along the slopes (in the thermal belt) and at higher elevations. Aspect affects the solar radiation and therefore the diurnal temperature range and the time of maxima and minima. Maxima will occur earlier, for example,

on east slopes than on west slopes. Even minor shape characteristics of topography have their effects. Concave areas will have a larger daily range than convex areas.

Large water bodies tend to moderate the daily temperature variation just as they moderate the seasonal variation. Coastal areas have a marine, rather than continental, climate.

Diurnal changes in temperature take place within the limitations of air-mass temperature. The passage of a front, evidence that another air mass has moved into the area, is reflected in the temperature pattern. Temperatures drop when a cold air mass moves in, and rise when a warm air mass moves in. In some cases the diurnal pattern is completely obscured. The temperature may continue to fall throughout the day when a very cold air mass moves in rapidly, or may continue to rise throughout the night when a warm air mass moves in. Along the west coast during the summer, a cool, marine air mass is usually found at low levels, and a warm, dry air mass is usually found above. A change in the vertical height of the boundary layer between these two air masses will appear in the temperature patterns along the slopes.

SUMMARY

In this chapter we have seen that temperature varies considerably in both time and space and for various reasons, most of which are related to the heating or cooling of the earth's surface. Temperature is a basic weather element that influences other weather elements. Differences in temperature create differences in air density and atmospheric pressure and therefore cause vertical and horizontal air movement. Through air movement, temperature differences influence the transport of heat, moisture, and atmospheric

pollutants such as smoke, haze, and industrial contaminants. The influence of temperature on atmospheric moisture is fundamental, not only in moisture transport, but in changes of state, particularly evaporation and condensation.

With the understanding of temperature variations that we now have, we are ready to consider atmospheric moisture-humidity in some detail.

Chapter 3

ATMOSPHERIC MOISTURE

Atmospheric moisture is a key element in fire weather. It has direct effects on the flammability of forest fuels, and, by its relationship to other weather factors, it has indirect effects on other aspects of fire behavior. There is a continuous exchange of water vapor between the atmosphere and dead wildland fuels. Dry fuels absorb moisture from a humid atmosphere and give up their moisture to dry air. During very dry periods, low humidity may also affect the moisture content of green fuels. When atmospheric moisture condenses and falls as precipitation, it increases the moisture content of dead fuels, and, by replenishing soil moisture, it provides for the growth of green vegetation.

We have already seen that moisture influences all surface temperatures, including surface fuel temperatures, by controlling radiation in its vapor state and by reflecting and radiating when it is condensed into clouds. The heat energy released in condensation provides the energy for thunderstorms and the violent winds associated with them. Moisture is also necessary for the development of lightning, which in many mountainous areas is a dreaded cause of wildfire.

ATMOSPHERIC MOISTURE

Water is always present in the lower atmosphere in one or more of its three states. It may exist as a **gas** (invisible water vapor), as a **liquid** (rain, drizzle, dew, or cloud droplets), and as a **solid** (snow, hail, sleet, frost, or ice crystals).

In its three states and in its changes from one state to another, water continually and

universally influences the weather. In a later chapter we will consider atmospheric processes involving water that produce clouds and precipitation. In the present chapter we will be concerned primarily with water vapor in the atmosphere - how it gets there, how it is measured, described, and distributed, and how it varies in time and space.

WATER VAPOR IN THE ATMOSPHERE

Moisture as vapor acts the same as any other gas. It mixes with other gases in the air, and yet maintains its own identity and characteristics. It is the raw material in condensation. It stores immense quantities of energy gained in evaporation; this energy is later released in condensation. Much of the energy for thunderstorms, tornadoes, hurricanes, and other strong winds comes from the heat released when water vapor condenses. The availability of water vapor for precipitation largely determines the ability of a region to grow vegetation, which later becomes the fuel for wildland fires.

Moisture in the atmosphere is continually changing its physical state condensing into

liquid, freezing into ice, melting into liquid water, evaporating into gaseous water vapor, and condensing back to liquid. These changes are all related to temperature, the gauge of molecular activity in any substance. At about -460°F . (absolute zero) the molecules of all substances are motionless. As the temperature rises, they move around at increasing speeds. Water molecules move slowly at subfreezing temperatures, more rapidly at melting temperature, and still more rapidly through the boiling stage. However, at any given temperature, individual molecules, whether solid, liquid, or gas, do not have the same speeds or direction of travel. Collisions that change their speeds and directions occur continuously.

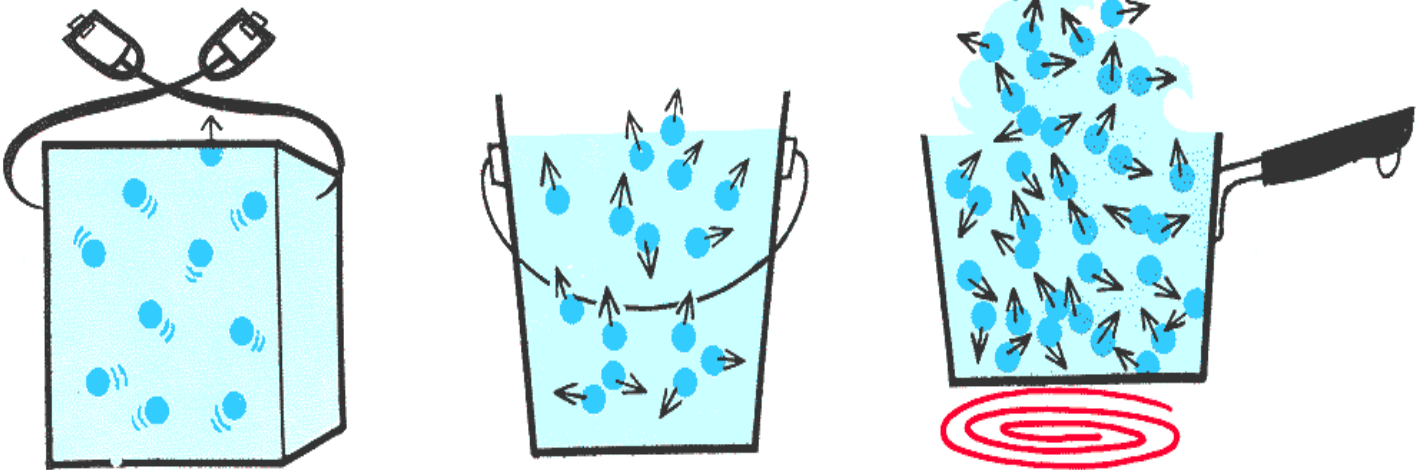

The internal pressure causing water vapor to escape from ice or liquid water varies greatly with the surface temperature; it is very small at cold temperatures and increases rapidly in liquid water through the boiling stage.

Evaporation

Some molecules momentarily acquire a very high speed from the impacts of other molecules. If this collision occurs in liquid water near the surface, and the high speed is in an outward direction, the molecules may escape into the air. This is **evaporation**, the process by which a liquid water molecule becomes a water-vapor molecule. Since molecules with the highest energy content escape, leaving behind in the liquid those with a lower energy content, the average level of energy of this liquid is decreased. The decrease in energy level results in a decrease in temperature of the liquid. Therefore, evaporation is a cooling process. Each molecule escaping into the air by a change of state takes with it nearly 1,000 times the energy needed to raise the temperature of a water molecule 1°F.

The pressure at the water-air boundary resulting from molecular motion in the direction of escape from the liquid is called the vapor pressure of water. This pressure varies only with the temperature of the water and determines

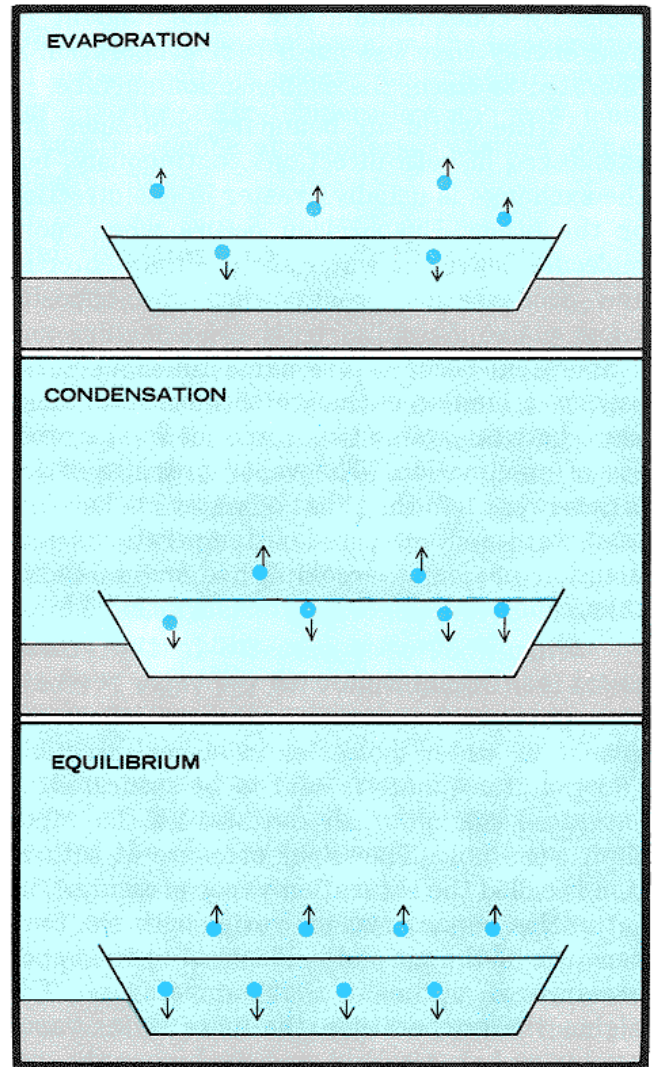

Evaporation occurs when an excess of water molecules leaves a water surface, and condensation occurs when an excess of molecular arms the liquid water. In an equilibrium condition, there is no net exchange in either direction, and the atmosphere is saturated.

the rate at which water molecules escape to the air and become vapor molecules. The water-vapor molecules, which escape to the air, displace air molecules and contribute their proportionate share to the total atmospheric pressure. This portion is called the partial pressure due to water vapor, or for simplicity, the vapor pressure.

Vapor pressure depends on the actual water vapor in the air, and it may vary from near zero in cold, dry air to about 2 inches of mercury in warm, moist air. High values can occur only in the warm, lower layers of the troposphere. The pressure produced by the vapor causes some water-vapor molecules to re-enter water sur-

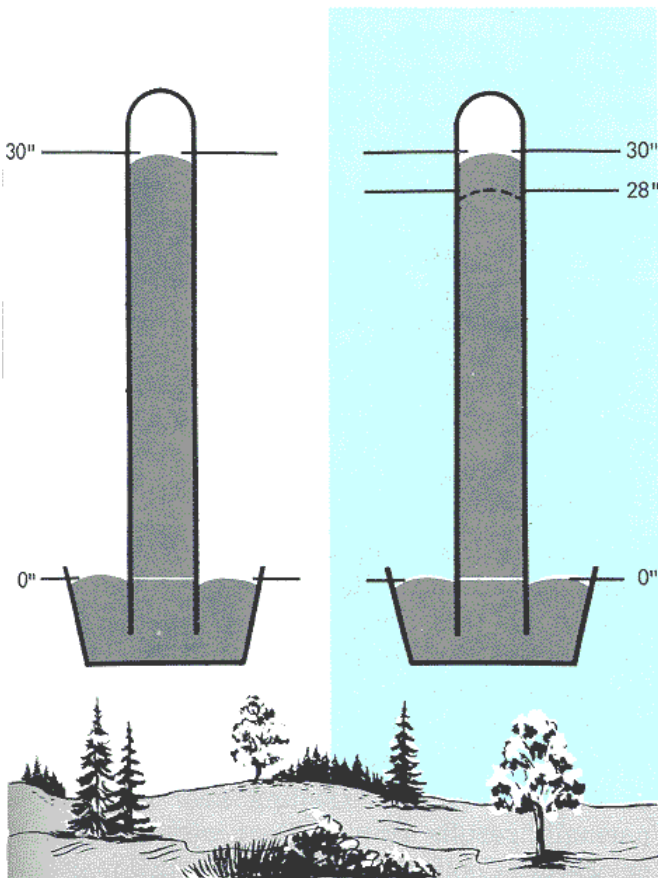

The partial pressure due to water vapor may vary from near zero in cold, dry air to about 2 inches of mercury in warm, moist air.

faces by condensation. The same amount of heat energy that was needed for evaporation is liberated to warm the condensation surface.

At the water-air boundary, molecules are exchanged in both directions continuously, but the exchange is usually greater in one direction or the other. Evaporation occurs when more molecules leave the water surface than enter it, and condensation occurs when the opposite takes place. Actually, both condensation and evaporation occur at the same time. As noted earlier, a similar exchange of molecules takes place between water vapor and ice in the process of sublimation. The vapor pressure of ice is somewhat less than that of water at the same temperature. Hence, at low temperatures sublimation on ice is accomplished more readily than condensation on a water surface.

When the vapor pressure in the atmosphere is in equilibrium with the vapor pressure of a water or ice surface, there is no net exchange of water molecules in either direction, and the atmosphere is said to be saturated. A saturated volume of air contains all the vapor that it can hold. The vapor pressure at saturation is called the **saturation vapor pressure**. The saturation vapor pressure varies with the temperature of the air and is identical to the vapor pressure of water at that temperature. The higher the temperature, the more water vapor a volume of air can hold, and the higher the saturation vapor pressure. Conversely, the lower the temperature, the lower the saturation vapor pressure. Table 1 illustrates how the saturation vapor pressure varies with temperature. In the common range of temperatures in the lower

atmosphere, the saturation vapor pressure just about doubles for each 20°F. increase in temperature. With this understanding of evaporation, condensation, and vapor pressure, we can now define several terms used to indicate the amount of moisture in the atmosphere.

Table 1. – Saturation water vapor pressure

Temperature, °F.	Pressure, inches of mercury
-40	0.006
-30	.010
-20	.017
-10	.028
0	.045 supercooled water
10	.071
20	.110
30	.166

40	.248
50	.362
60	.522
70	.739
80	1.032
90	1.422
100	1.933

212	29.92 boiling water (sea level)

The air near the surface is usually not saturated; therefore, the actual vapor pressure is usually less than the saturation vapor pressure. The actual vapor pressure can be raised to saturation vapor pressure by evaporating more moisture into the air, or, since saturation vapor pressure varies with temperature, the air can be cooled until the saturation vapor pressure is equal to the actual vapor pressure. Evaporation alone does not ordinarily saturate the air except very close to the evaporating surface. Normal circulation usually carries evaporated moisture away from the evaporating surface.

Dew Point

Saturation is usually reached by the air being cooled until its saturation vapor pressure equals the actual vapor pressure. The temperature of the air at that point is called the dew-point temperature, or simply, the **dew point**. Further cooling causes some of the vapor to condense into liquid droplets that form clouds, fog, or dew. Cooling near the surface normally results from contact with cool ground or water. Cooling to the dew point may also occur by lifting moist air to higher altitudes; it is thus cooled adiabatically. For example,

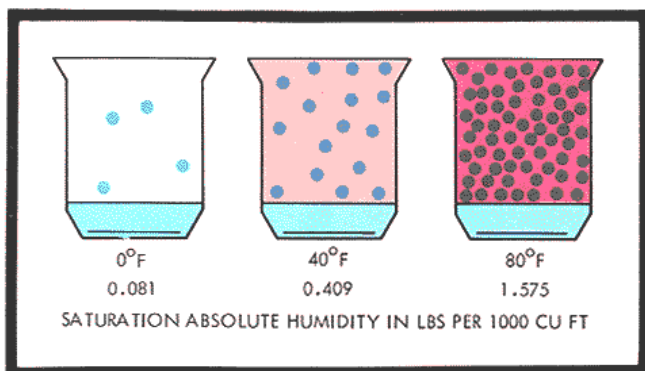

The saturation absolute humidity and saturation vapor pressure both vary with the temperature. The higher the temperature, the more water vapor a volume of air can hold.

consider air with a temperature of 80°F. and a vapor pressure of 0.362 inches of mercury. Referring to table 1, we find that if the air is cooled to 50, the actual vapor pressure will equal the saturation vapor pressure. Therefore, 50° is the dew point.

If the air is cooled below its dew point, condensation occurs because the amount of water vapor in the air exceeds the maximum amount that can be contained at the lower temperature. Under ordinary circumstances the actual vapor pressure cannot exceed the saturation vapor pressure by more than a very small amount.

Absolute Humidity

The actual amount of water vapor in a given volume of air, that is, the weight per volume, such as pounds per 1,000 cubic feet, is called the **absolute humidity**. A direct relationship exists among the dew point, the vapor pressure, and the absolute humidity because, at constant atmospheric pressure, each of these depends only on the actual amount of water vapor in the air. At saturation, the dew point is the same as the temperature, the vapor pressure is the saturation vapor pressure, and the absolute humidity is the saturation absolute humidity.

Table 2 shows the relationship among these three measures of atmospheric moisture. Saturation values of vapor pressure and absolute humidity can be obtained by entering temperature

Table 2. - Dew point, vapor pressure, and absolute humidity

Dew point (temperature) (°F.)	Vapor pressure (saturation) (Inches of Hg.)	Absolute humidity (saturation) (Pounds per M cubic feet)
-40	0.006	0.011
-30	.010	.019
-20	.017	.031
-10	.028	.051
0	.045	.081
10	.071	.125
20	.110	.198
30	.166	.279
40	.248	.409
50	.362	.585
60	.522	.827
70	.739	1.149
80	1.032	1.575
90	1.422	2.131
100	1.933	2.844
110	2.597	3.754

instead of dew point in the first column. Because of these relationships, the temperature of the dew point is a convenient unit of measure for moisture. Air temperature and dew point accurately define atmospheric moisture at any time or place.

Relative Humidity

Saturation of surface air is a condition of favorable fire weather; that is, conducive to low fire danger. Less favorable are conditions of unsaturation, which permit evaporation from forest fuels, increasing their flammability and the fire danger. Therefore, a very useful measure of atmospheric moisture is the **relative humidity**. It is the ratio, in percent, of the amount of moisture in a volume of air to the total amount which that volume can hold at the given temperature and atmospheric pressure. Relative humidity is also the ratio of actual vapor pressure to saturation vapor pressure, times 100. It ranges from 100 percent at saturation to near zero for very dry air. Relative humidity depends on the actual moisture content of the air, the temperature, and the pressure.

The dependence of relative humidity on temperature must be kept in mind. Suppose that we have air at 80°F. and 24 percent relative humidity. Using table 2, we find that the saturation vapor pressure for 800 is 1.032 inches of mercury. We can compute the actual vapor pressure by multiplying 1.032 by 0.24. The actual vapor pressure is 0.248 rounded off. The

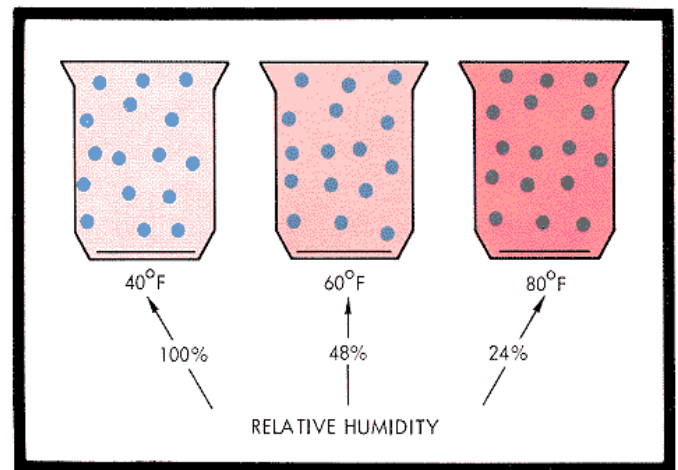

Relative humidity decreases as temperature increases even though the amount of water vapor in the air remains the same.

dew point for this vapor pressure is 40°. We now know that if the air was cooled from 80°F. to 40°, with no other change, the humidity would increase from 24 percent to 100 percent and the air would be saturated. At that temperature the actual vapor pressure would equal the saturation vapor pressure. The absolute humidity in table 2 could be used in a similar manner. Thus, the relative humidity may change considerably with no addition of moisture—just by cooling alone.

MEASURING HUMIDITY

The most widely used device for accurately measuring atmospheric moisture near the surface is the **psychrometer**. It consists of two identical mercurial thermometers. One thermometer is used for measuring the air temperature; the other measures the temperature of evaporating water contained in a muslin wicking surrounding the thermometer bulb. The amount that the evaporating surface will cool is determined by the difference between the vapor pressure and the saturation vapor pressure. The first reading is commonly referred to as the dry-bulb temperature and the second as the wet-bulb temperature. The wet-bulb temperature is the steady value reached during a period of brisk ventilation of the thermometer bulbs. If the air is saturated, the wet-bulb and dry-bulb temperatures are the same.

From the wet- and dry-bulb measurements, computed values of dew-point temperature, absolute humidity, and relative humidity may be read from tables or slide rules. As noted earlier, these moisture relations vary with changes in pressure. The daily pressure changes as shown by the barometer are not large enough to be important, but those due to differences in elevation are significant. They have been considered in the construction of the tables or slide rules. The ones labeled with the correct pressure must be used. Table 3 gives the ranges of land elevations for which **psychrometric tables** for different pressures may be used.

Table 4 is a sample of one of the simplest types of tables. Either relative humidity or dew point may be obtained directly from wet-bulb and dry-bulb readings. As an example, suppose the air temperature (dry-bulb) was 75°F.

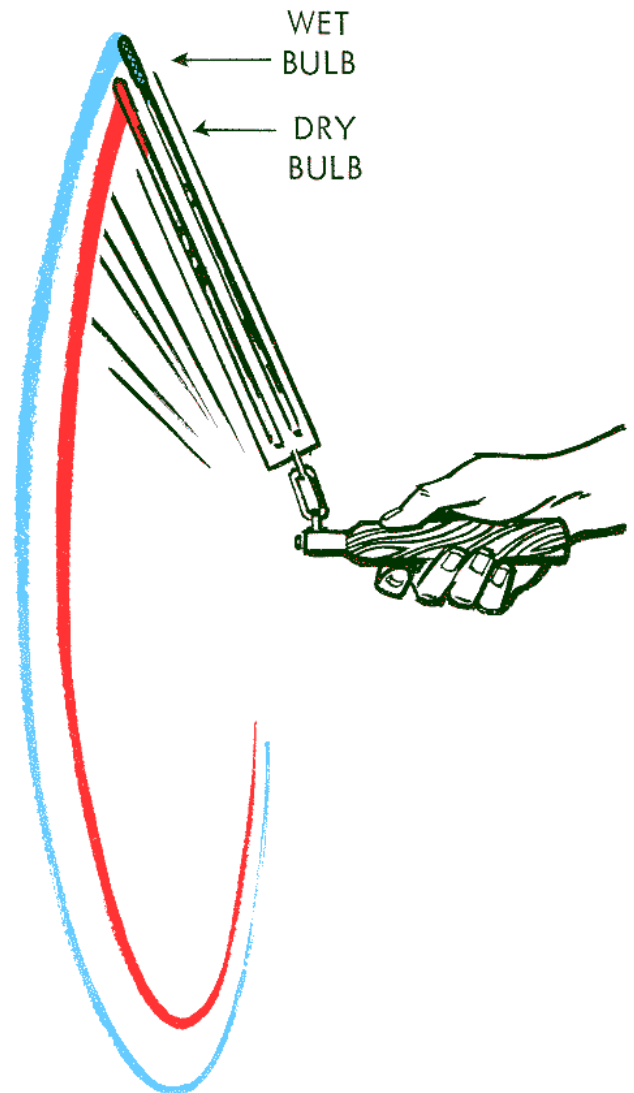

Wet-bulb and dry-bulb temperatures are obtained with a psychrometer. Dew point, relative humidity, and other measures of air moisture may be obtained from these readings.

and the wet-bulb temperature was 64° at a station 1,500 feet above sea level. Entering table 4 (which is the table for 29 inches of mercury) with the dry-bulb reading on the left and the wet-bulb reading at the top, we find at the intersection that the relative humidity is 55 percent (black figure) and the dew point is 58°F. (red figure).

Other tables in common use require that the wet-bulb depression (the dry-bulb temperature minus the wet-bulb temperature) be computed first. One table is entered with this value and the dry-bulb reading to obtain the dew point; another table is entered with the same two readings to obtain the relative humidity.

Table 3. – Psychrometric tables for different

Elevations		Psychrometric table (Inches of hg.)
Elevation above sea level (Except Alaska) (Feet)	(Alaska)	
0-500	0-300	30
501-1900	301-1700	29
1901-3900	1701-3600	27
3901-6100	3601-5700	25
6101-8500	5701-7900	23

Other instruments used to measure relative humidity contain fibers of various materials that swell or shrink with changing relative humidity. One instrument of this type that records a continuous trace of relative humidity is called a **hygrograph**. A more common form in use at fire-weather stations is the **hygrothermograph**, which records both relative humidity and temperature. Other devices, such

as those commonly used for upper-air soundings, employ moisture-sensitive elements that change in electrical or chemical characteristics with changing humidity.

Standard surface measurements of relative humidity, like those of temperature, are made in an instrument shelter 4 1/2 feet above the ground. A properly operated sting psychrometer, however, will indicate dry- and we-bulb readings that agree well with those obtained in the shelter. The only necessary precautions are to select a well-ventilated shady spot, and to whirl the instrument rapidly for a sufficient time to get the true (lowest) wet-bulb temperature. Care must be taken not to allow the wicking to dry out, and not to break the thermometer by striking any object while whirling the psychrometer.

SOURCES OF ATMOSPHERIC MOISTURE

Water vapor in the air comes almost entirely from three sources: Evaporation from any moist surface or body of water, evaporation

from soil, and transpiration from plants. Some water vapor results from combustion. Because the oceans cover more than three-fourths of

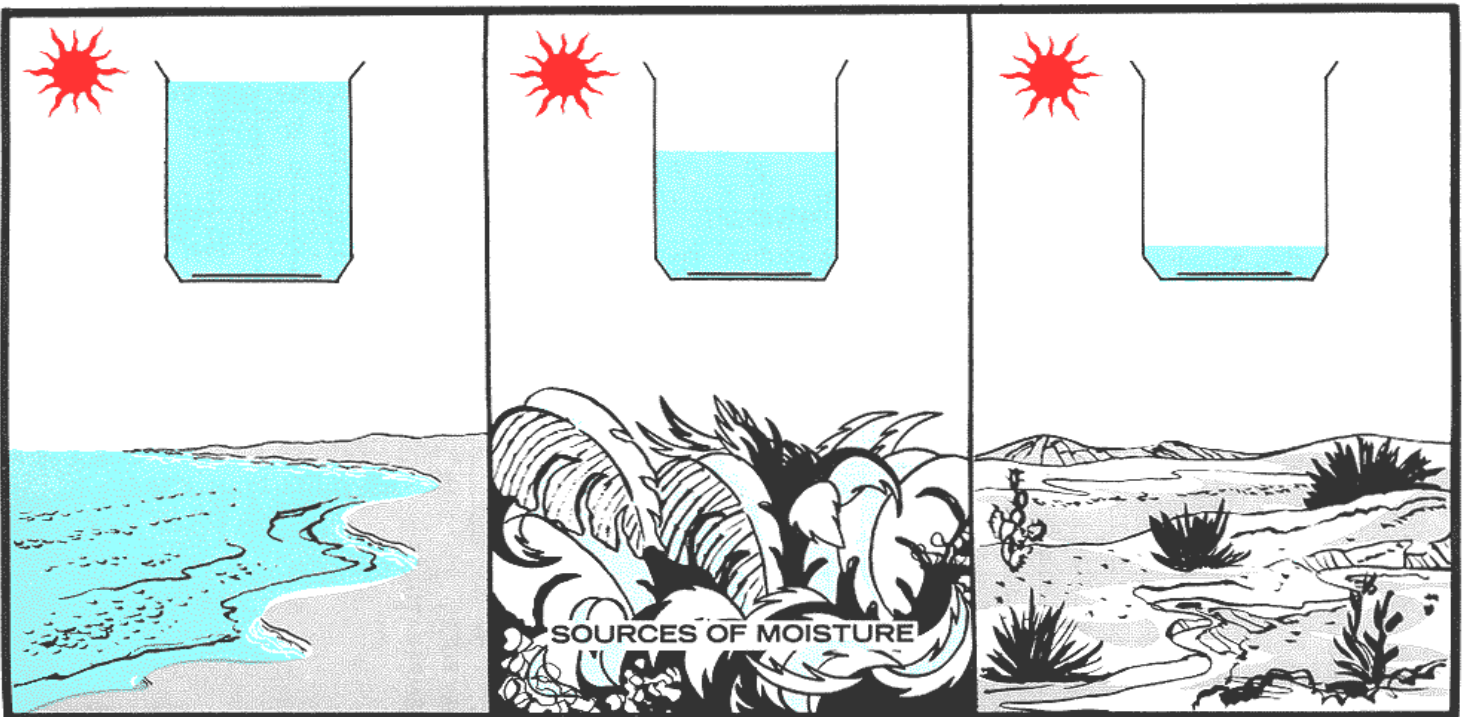

Although the oceans are the principal source of atmospheric moisture, transpiration from plant, is also important. But in and areas, transpiration adds little moisture to the atmosphere.

Table 4. – Relative humidity and dew-point table for use at elevations between 501 and 1900 feet above sea level. Relative humidity in percent is shown in black: dew point in °F. is shown in red.

WET BULB TEMPERATURES

		39	40	41	42	43	44	45	46	47	48	49	50	51	52	53	54	55	56	57	58	59	60	61	62	63	64	65																																	
61	-50	-14	-1	+8	14	19	24	28	31	34	37	40	42	44	47	49	51	53	54	56	58	59	61																																						
62		-25	-6	+4	11	17	22	26	30	33	36	38	41	43	46	48	50	52	54	55	57	59	60	62																																					
63		-38	-14	-1	+8	14	20	24	28	31	34	37	40	42	45	47	49	51	53	55	57	58	60	61	63																																				
64			-27	-7	+4	11	17	22	26	30	33	36	39	41	44	46	48	50	52	54	56	58	59	61	62	64																																			
65				-15	-1	+8	14	20	24	28	31	34	37	40	42	45	47	49	51	53	55	57	59	60	62	63	65																																		
66			-28	-7	+4	11	17	22	26	30	33	36	39	41	44	46	48	49	51	53	54	56	58	60	61	63	64	66																																	
67				-15	-1	+8	15	20	24	28	32	35	38	41	43	46	48	50	52	54	56	57	59	61	62	64	66	67																																	
68				-29	-7	+4	12	18	22	27	30	34	37	40	42	45	47	49	51	53	55	57	59	60	62	63	65	67																																	
69					-15	-1	+8	15	20	25	29	32	35	38	41	44	46	48	50	52	54	56	58	60	61	63	65	66	69																																
70						-29	-7	+4	12	18	23	27	31	34	37	40	43	45	47	50	52	54	55	57	59	61	62	64	66	67	69	70																													
71						-15	0	+9	15	21	25	29	33	36	39	42	44	46	49	51	53	55	57	58	60	62	63	65	67	68	70																														
72						-28	-6	+5	12	18	23	28	31	35	38	40	43	46	48	50	52	54	56	58	60	61	63	65	67	68	70																														
73							-14	0	+9	16	21	26	30	33	36	39	42	45	47	49	51	53	55	57	59	61	62	64	66	67	69	70																													
74								-27	-6	+5	13	19	24	28	32	35	38	41	44	46	48	51	53	55	57	58	60	62	64	65	67	68	70																												
75									-3	+1	10	16	22	26	30	34	37	40	43	45	48	50	52	54	56	58	60	61	63	65	66	68	69	71	72	74	75																								
76										-25	-5	+6	14	20	24	29	32	36	39	42	44	47	49	51	53	55	57	59	61	62	64	66	67	69	70	72	73	75	76																						
77											-57	-12	+2	10	17	22	27	31	35	38	41	43	46	48	50	53	55	57	58	60	62	64	65	67	68	70	71	73	74	76	77																				
78												-23	-4	+7	14	20	25	29	33	36	39	42	45	47	50	52	54	56	58	60	61	63	65	66	68	69	71	72	74	75	77	78																			
79													-48	-11	+3	11	18	23	28	32	35	38	41	44	46	49	51	53	55	57	59	61	63	64	66	67	69	71	72	73	75	76	78	79																	
80														-21	-2	+6	13	19	25	30	34	37	40	43	45	48	50	52	54	56	58	61	62	64	65	67	68	69	71	72	73	75	76	77	79	80	81	82	83	84	85										
81															-40	-9	+4	12	19	24	28	32	36	39	42	45	47	49	52	54	56	58	60	61	63	65	67	68	69	71	72	73	74	75	76	77	78	79	80	81	82	83	84	85							
82																-18	-1	+9	16	22	27	31	34	38	41	44	46	49	51	53	55	57	59	61	63	64	66	68	69	71	72	73	74	75	76	77	78	79	80	81	82	83	84	85							
83																	-34	-7	+3	13	20	25	29	33	36	40	43	45	48	50	52	54	56	58	60	61	63	64	66	68	69	71	72	73	74	75	76	77	78	79	80	81	82	83	84	85					
84																		-15	+1	10	17	23	27	32	35	38	41	44	46	49	51	53	55	57	59	61	62	64	65	67	68	69	71	72	73	74	75	76	77	78	79	80	81	82	83	84	85				
85																			-29	-5	+7	14	21	26	30	34	37	40	43	46	48	51	53	55	57	59	61	62	64	65	67	68	69	71	72	73	74	75	76	77	78	79	80	81	82	83	84	85			
86																				-12	+2	11	18	24	28	32	36	39	42	45	48	50	52	54	56	58	60	62	63	65	66	67	69	71	72	73	74	75	76	77	78	79	80	81	82	83	84	85			
87																					-24	-3	+8	16	22	27	31	35	38	41	44	47	49	52	54	56	58	60	62	64	65	67	69	70	71	72	73	74	75	76	77	78	79	80	81	82	83	84	85		
88																						-50	-10	+4	13	19	25	29	33	37	40	43	46	48	51	53	55	57	59	61	62	64	65	67	69	70	71	72	73	74	75	76	77	78	79	80	81	82	83	84	85
89																							-19	-1	+10	17	23	28	32	36	39	42	45	48	50	52	53	55	57	59	61	62	64	65	67	69	71	72	73	74	75	76	77	78	79	80	81	82	83	84	85
90																								-37	-7	+6	14	21	26	30	34	38	41	44	47	49	52	54	56	58	60	62	64	65	67	69	71	72	73	74	75	76	77	78	79	80	81	82	83	84	85

the earth's surface, they are the most important moisture source, but land sources can also be important locally.

Plants have large surfaces for transpiration; occasionally they have as much as 40 square yards for each square yard of ground area. Transpiration from an area of dense vegetation can contribute up to eight times as much moisture to the atmosphere as can an equal area of bare ground. The amount of moisture transpired depends greatly on the growth activity. This growth activity, in turn, usually varies with the season and with the ground water supply. In areas of deficient rainfall and sparse vegetation, such as many areas in the arid West, both transpiration and evaporation may be almost negligible toward the end of the dry season. This may also be common at timberline and at latitudes in the Far North.

In evaporation from water bodies, soil, and dead plant material, the rate at which moisture is given up to the air varies with the difference between the vapor pressure at the evaporating surface and the atmospheric vapor pressure. Evaporation will continue as long as the vapor pressure at the evaporating surface is greater than the atmospheric vapor pressure. The rate of evaporation increases with increases in the pressure difference. The vapor pressure at the evaporating surface varies with the temperature of that surface. Therefore, evaporation from the surfaces of warm water bodies, warm soil, and dead plant material will be greater than from cold surfaces, assuming that the atmospheric vapor pressure is the same.

Transpiration from living plants does not vary as evaporation from dead plant material. Living plants will usually transpire at their highest rates during warm weather, but an internal regulating process tends to limit the water-loss rate on excessively hot and dry days to the plant's particular current needs. We will discuss evaporation from dead **plant material** and

transpiration from living plants more fully in the chapter on fuel moisture (chapter 11).

In still air during evaporation, water vapor concentrates near the evaporating surface. If this concentration approaches saturation, further evaporation will virtually halt, even though the surrounding air is relatively dry. **Wind** encourages evaporation by blowing away these stagnated layers and replacing them with drier air. After a surface has dried to the point where free water is no longer exposed to the air, the effect of wind on evaporation decreases. In fact, for surfaces like comparatively dry soil or wood, wind may actually help reverse the process by cooling the surfaces and thus lowering the vapor pressure of moisture which these surfaces contain.

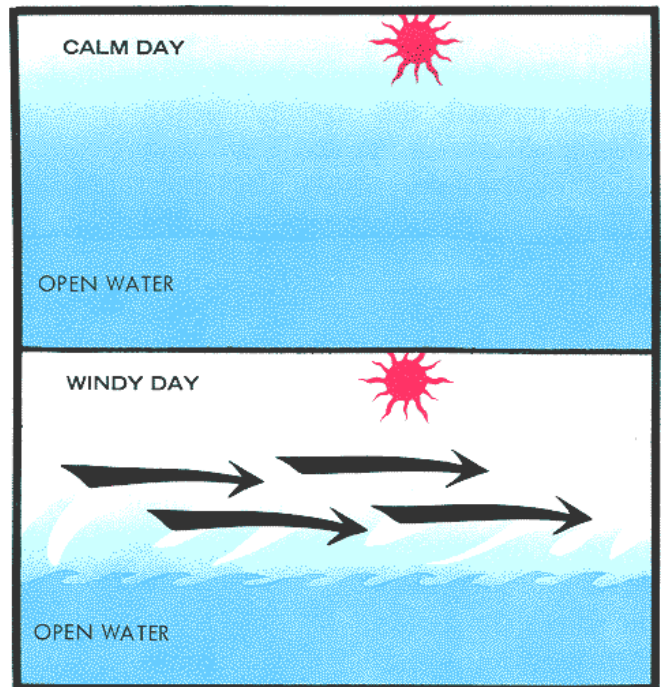

Wind encourages evaporation by blowing away stagnated layers of moist air and by mixing moist air with drier air aloft.

VARIATIONS IN ABSOLUTE HUMIDITY

The actual amount of moisture in the air will vary from one air mass to another, and even within an air mass there will be continuing variations in time and space.

The moisture contents of air masses are basically related to their regions of origin. Air masses originating in continental areas are relatively dry. Those coming from the Atlantic

or the Gulf of Mexico are moist, and those from the Pacific are moist or moderately moist. As these maritime air masses invade the continent, land stations will observe abrupt rises in absolute humidity. As any air mass traverses areas different from its source region, gradual changes take place as evaporation, transpiration, condensation, and precipitation add or subtract moisture.

Through a deep layer within an air mass, the absolute humidity, like the temperature, usually **decreases with height**. There are several reasons for this distribution. **First**, moisture is added to the atmosphere from the surface and is carried upward by convection and upslope and up valley winds. **Second**, when air is lifted, the water vapor, as well as the air, expands proportionately so that the moisture in any given volume becomes less and less. Thus, the absolute humidity decreases as the air is lifted. **Third**, since temperature usually decreases upward, the capacity for air to hold moisture decreases upward. **Finally**, the precipitation process removes condensed moisture from higher levels in the atmosphere and deposits it at the surface.

The normal pattern of decrease of moisture with altitude may be altered occasionally when horizontal flow at intermediate levels aloft brings in moist air. Such flow is responsible for much of the summer thunderstorm activity over large parts of the West. Extremely low absolute humidity is found in subsiding air aloft. This dry air originates near the top of the troposphere and slowly sinks to lower levels. If it reaches the ground, or is mixed downward, it may produce acutely low humidity near the surface and an abrupt increase in fire danger. We will consider **subsidence** in more detail in the next chapter.

If we consider only a very shallow layer of air near the surface, we find that the vertical variation of absolute humidity with height will change during each 24-hour period as conditions favoring evaporation alternate with conditions favoring condensation. During clear days, moisture usually is added to the air by evaporation

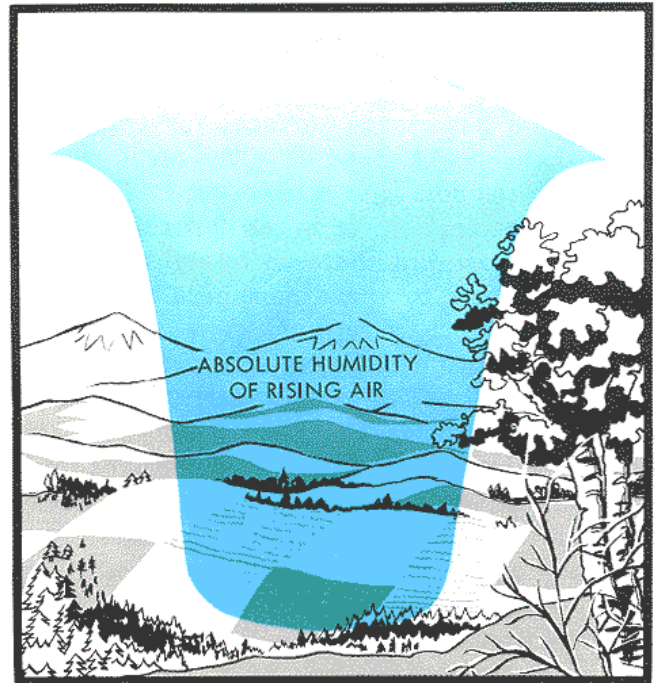

As moist air rises, it expands, and the moisture in a given volume, the absolute humidity, becomes less and less.

from warm surfaces; therefore, the absolute humidity decreases upward.

At night, moisture is usually taken from the air near the surface by condensation on cold surfaces and absorption by cold soil and other substances; thus, the absolute humidity may increase upward through a very shallow layer.

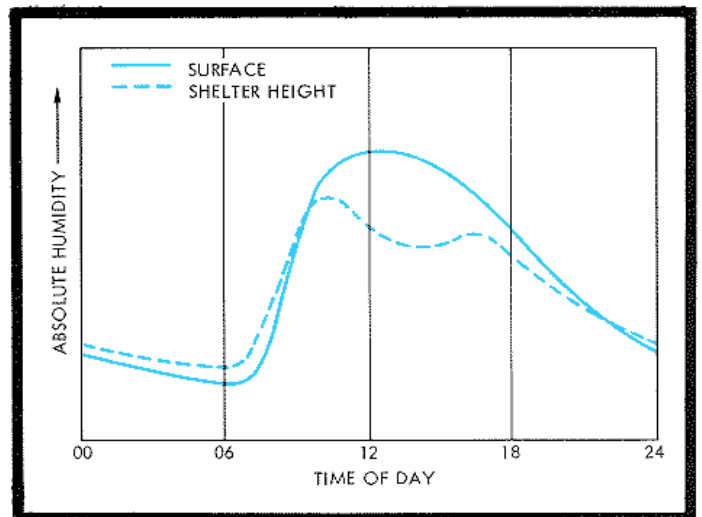

Schematic representation of surface absolute humidity compared to that at shelter height. Air near the surface is likely to contain less moisture than air at shelter height during the night, and more moisture during the day.

DIURNAL AND SEASONAL CHANGES IN RELATIVE HUMIDITY

Relative humidity is much more variable than absolute humidity. It often changes rapidly and in significant amounts from one hour to the next and from place to place. Relative humidity is much more variable because it depends not only on absolute humidity but also on air temperature. It varies directly with moisture content and inversely with temperature. Because of these relationships, it is often not possible to make general statements about relative humidity variations, particularly vertical variations within short distances above the ground.

During the day near the surface, particularly with clear skies, both the temperature and absolute humidity usually decrease with height. These two variables have opposite effects on the relative humidity. Which effect is dominant depends upon the dryness of the surface. The relative humidity usually increases with height over normal surfaces because the effect of the decrease in temperature is greater than that of the decrease in absolute humidity. Over a moist surface, however, the effect of the decrease in absolute humidity may overbalance that of temperature decrease, and the relative humidity in the surface layer will decrease with height.

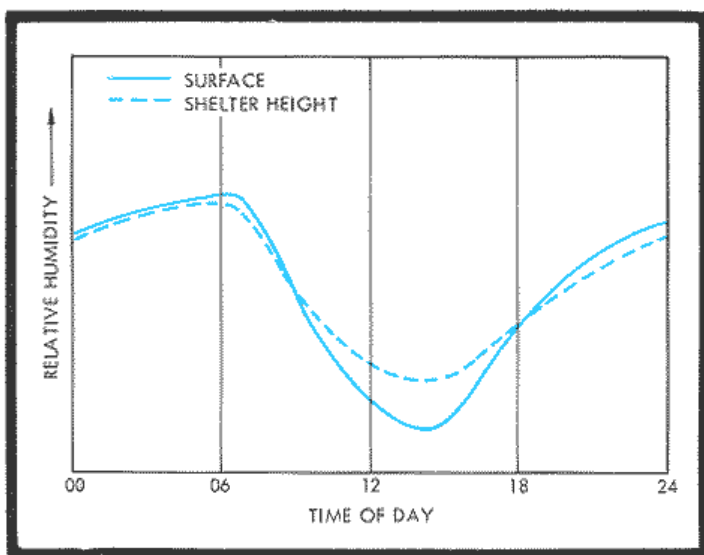

Schematic representation of surface relative humidity compared to that at shelter height. Due to the effect of temperature, relative humidity near the ground is usually lower than at shelter height during the day, and higher at night.

At night, the change of temperature with height usually predominates, and the relative humidity will decrease with height through the lowest layers.

Above the lowest layers, the relative humidity generally increases with height in the day through much of the lower troposphere. Convection alone would account for this increase. As air is lifted, the temperature decreases 5.5°F. per 1,000 feet, and the dew point decreases at about 1°F. per 1,000 feet. Therefore, the dew point and the temperature become 4.5°F. closer per 1,000 feet, and the relative humidity increases until saturation is reached.

A subsiding layer of air in the troposphere warms by the adiabatic process and forms a **subsidence inversion**. The relative humidity will decrease upward through the temperature inversion at the base of the subsiding layer. The marine inversion along the west coast, for example, is a subsidence inversion. The marine air below has low temperatures and high humidities, and the adiabatically heated subsiding air mass above has higher temperatures and lower humidities. This pronounced change in temperature and humidity is evident along the slopes of coastal mountains when the marine inversion is present.

Relative humidity is most important as a fire-weather factor in the layer near the ground, where it influences both fuels and fire behavior. Near the ground, air moisture content, season, time of day, slope, aspect, elevation, clouds, and vegetation all cause important variations in relative humidity.

Since hourly and daily changes of relative humidity are normally measured in a standard instrument shelter, we will consider variations at that level and infer from our knowledge of surface temperatures what the conditions are near the surface around forest fuels.

A typical fair-weather pattern of relative humidity, as shown on a hygrothermograph exposed in a shelter at a valley station or one in flat terrain, is nearly a mirror image of the temperature pattern. Maximum humidity generally occurs about daybreak, at the time of

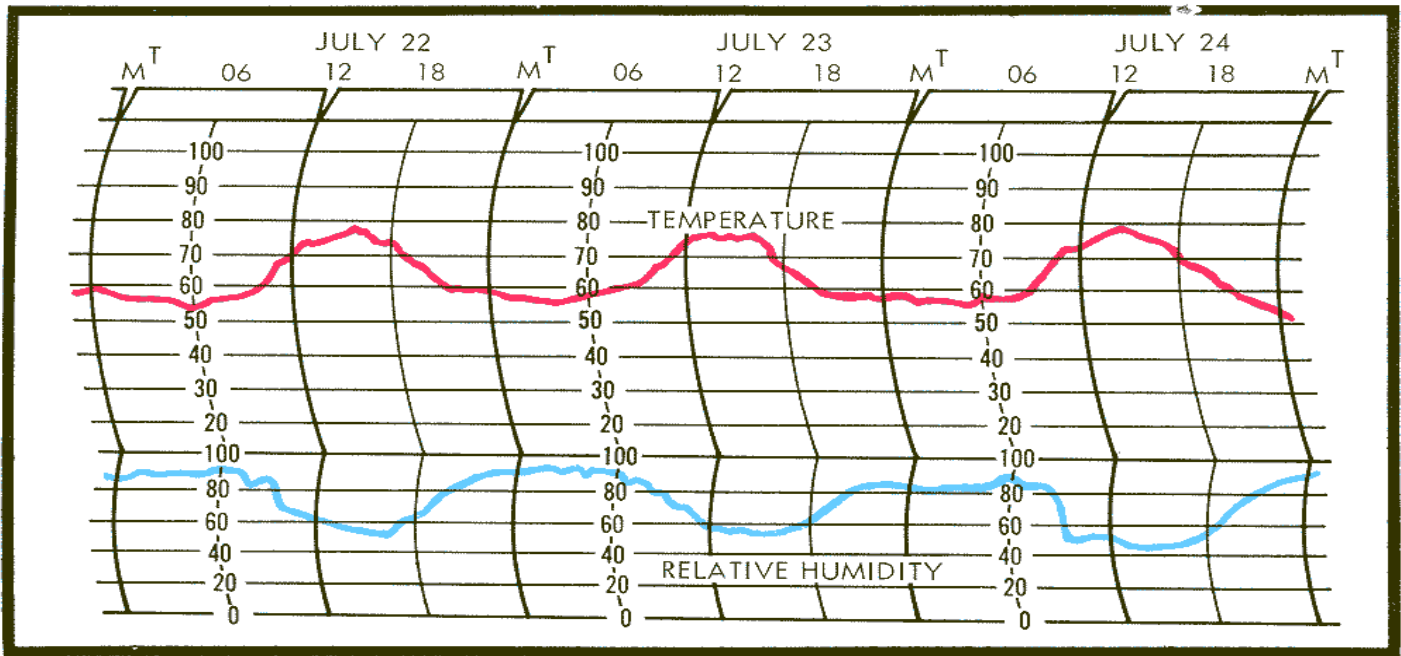

Typical temperature and relative humidity traces for a low-level station are nearly mirror images of each other.

minimum temperature. After sunrise, humidity drops rapidly and reaches a minimum at about the time of maximum temperature. It rises more gradually from late afternoon through the night. The daily range of humidity is usually greatest when the daily range of temperature is greatest. Variations in the humidity traces within an air mass from one day to the next are usually small, reflecting mostly differences in temperatures. But over several days, there may be noticeable cumulative differences in humidity as the air mass gradually picks up or loses moisture.

Seasonal changes in relative humidity patterns are also apparent. In western fire-weather seasons that begin following a moist spring and continue through the summer and early fall, a seasonal change is particularly noticeable. Daily temperature ranges are greatest early in the fire season when the sun is nearly overhead and night skies are clear. Strong nighttime cooling, in combination with ample moisture in the soil and vegetation to contribute moisture to the atmosphere, often boosts night humidities to or near 100 percent. Intensive daytime surface heating and convective transport

of moisture upward combine to drop the relative humidity to low levels in the afternoon.

As the season progresses, soil and vegetation dry out and solar heating diminishes as the sun tracks farther south. Daytime humidities become even lower late in the season, but, with a greater reduction in night humidities, the daily range is reduced, and the fire weather is further intensified. Occasional summer rains may interrupt this progression but do not greatly change the overall seasonal pattern.

In areas that have separate spring and fall fire seasons, the daily temperature extremes are generally not so striking. Also, the cumulative drying of soil and vegetation is not so consistent, except during unusual drought. Because periodic rains generally occur during the seasons, the humidity changes tend to be somewhat variable. In some areas, seasonal increases in relative humidity decrease fire danger during the summer. In the Great Lakes region, particularly, where the many small lakes become quite warm during the summer and transpiration from vegetation is at its peak, daytime relative humidities do not reach as low values

in the same air mass types as they do in spring and fall.

The relative humidity that affects fuels on the forest floor is of ten quite different from that in the instrument shelter, particularly in unshaded areas where soil and surface fuels exposed to the sun are heated intensely, and warm the air surrounding them. This very warm air may have a dew point nearly the same or slightly higher than the air in the instrument shelter, but because it is much warmer, it has a much lower relative humidity.

It is impractical to measure humidity close to the ground with field instruments, but with the aid of tables, the humidity can be estimated from psychrometric readings at the standard height and a dry-bulb temperature reading at the surface. We must assume that the dew point is the same at both levels. Although we know that this may not be exact, it will give a reasonable estimation.

Consider the following example, using table 4, for a pressure of 29 inches:

Height of Measurement	Dry-bulb	Wet-bulb	Dew point	Relative humidity, percent
4 ½ feet	¹ 80	¹ 65	² 56	³ 245
1 inch	¹ 140		² 56	³ 38
	¹ Observed.	² Calculated.	³ Estimated	

The 8-percent relative was obtained from a complete set of tables, using a dry-bulb temperature of 140°F. and a dew point of 56°F.

With similar exposure at night, humidities are likely to be higher near the ground than in the shelter because of radiative cooling of the surface. Often, dew will form on the surface - indicating 100 percent relative humidity-when the humidity at shelter height may be considerably below the saturation level.

These conditions are typical for relatively still air, clear skies, and open exposure. When wind speeds reach about 8 miles per hour, the increased mixing diminishes the difference between surface and shelter-height humidities. Also, under heavy cloud cover or shade, the humidity differences between the two levels tend to disappear because the principal radiating surface is above both levels.

EFFECTS OF TERRAIN, WIND, CLOUDS, VEGETATION, AND AIR MASS CHANGES

Humidity may vary considerably from one spot to another, depending greatly on the topography. In relatively flat to rolling terrain, the humidity measured at a well-exposed station may be quite representative of a fairly large area. There will be local exceptions along streams, irrigated fields, in shaded woods, or in barren areas. In the daytime particularly, circulation and mixing are usually sufficient to smooth out local effects over relatively short distances.

In mountainous topography, the effects of elevation and aspect become important, and humidities vary more than over gentle terrain. Low elevations warm up and dry out earlier in the spring than do high elevations. South slopes also are more advanced seasonally than north slopes. As the season progresses, cumulative drying tends to even out these differences since stored moisture in the surface is depleted, but the differences do not disappear.

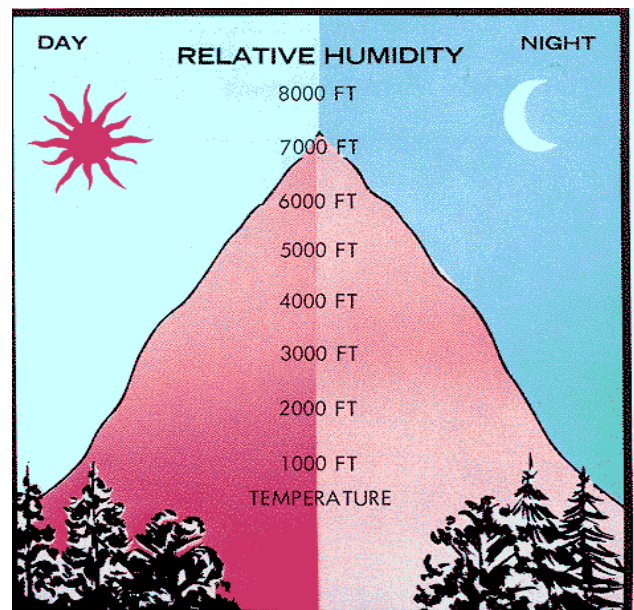

During daytime, relative humidity usually increases upward along slopes, largely because of the temperature decreases. At night, if an inversion is present, relative humidity decreases up the slope to the top of the inversion, then changes little or increases slightly with elevation.

We mentioned earlier that daytime temperatures normally decrease with altitude in the free air. The decrease with height of both temperature and dew point produces higher relative humidities at higher elevations on slopes. The pattern is complicated, however, because of heating of the air next to the slopes, the transport of moisture with upslope winds, and the frequent stratification of moisture into layers, so generalizations are difficult to make.

When nighttime cooling begins, the temperature change with height is usually reversed. Cold air flowing down the slopes accumulates at the bottom. As the night progresses, additional cooling occurs, and by morning, if the air becomes saturated, fog or dew forms. Relative humidity may decrease from 100 percent at the foot of the slope to a minimum value at the top of the temperature inversion-the thermal belt, which was discussed in chapter 2 - and then may increase slightly farther up the slope above the inversion.

Just as south slopes dry out faster because of their higher day temperatures, they also have somewhat lower day relative humidities than north slopes throughout the summer. At upper elevations, though, the difference between north and south slopes becomes negligible because of the good air mixing at these more exposed sites. At night, humidity differences on north and south slopes become slight.

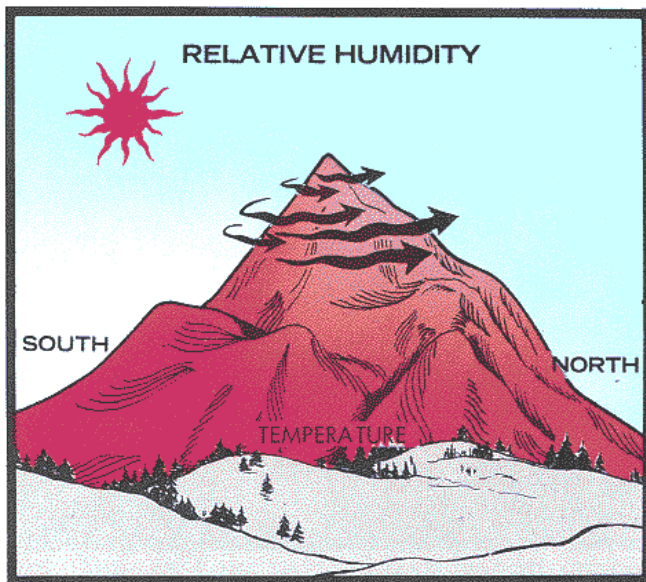

During the day, south slopes have lower relative humidities than north slopes; but at upper elevations, because of good air mixing, the difference is negligible.

In most mountainous country, the daily range of relative humidity is greatest in valley bottoms and least at higher elevations. Thus, while fires on lower slopes may burn better during the day, they often quiet down considerably at night when humidity increases. But at higher elevations, particularly in and above the thermal belt, fires may continue to burn aggressively through the night as humidities remain low, temperatures stay higher, and wind speed is greater.

Again, we should be cautious of generalizations. For example, in the summer in the Pacific coast ranges, higher humidities are usually found on ridge tops during the day than during the night. This anomaly results from slope winds carrying moisture upward from the moist marine air layer during the day. Moist air that is not carried away aloft settles back down at night.

Wind mixes evaporating water vapor with surrounding air and evens out temperature extremes by moving air away from hot and cold surfaces. Thus, diurnal ranges of relative humidity are less during windy periods than during calm periods. Winds also reduce place-to-place differences by mixing air of different moisture contents and different temperatures. Patches of fog on a calm night indicate poor ventilation.

Clouds strongly affect heating and cooling and therefore influence the relative humidity. The humidity will be higher on cloudy days and lower on cloudy nights. Thus, clouds reduce the daily range considerably. Precipitation in any form raises relative humidities by cooling the air and by supplying moisture for evaporation into the air.

Vegetation moderates surface temperatures and contributes to air moisture through transpiration and evaporation-both factors that affect local relative humidity. A continuous forest canopy has the added effect of decreasing surface wind speeds and the mixing that takes place with air movement.

The differences in humidity between forest stands and open areas generally vary with the density of the crown canopy. Under a closed canopy, humidity is normally higher than outside during the day, and lower at night. The

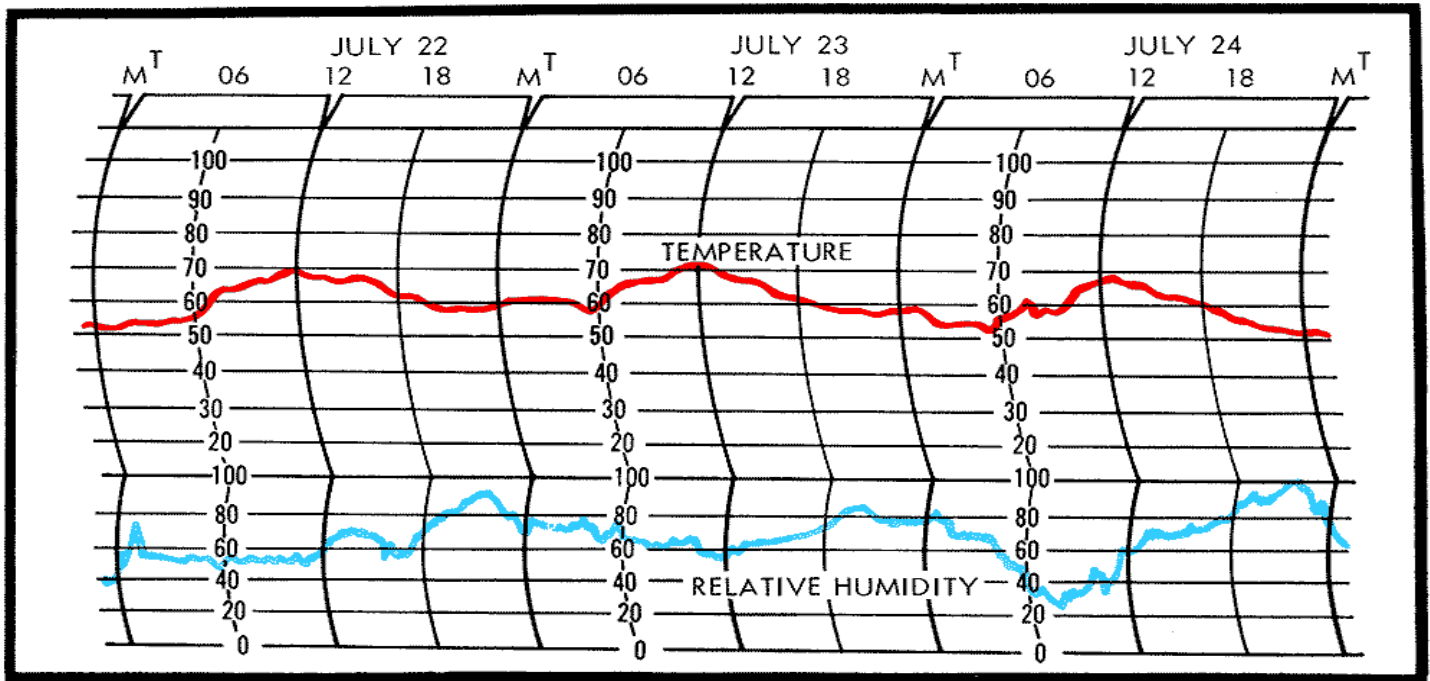

Temperature and relative humidity traces at mountain stations are often less closely related than at valley stations. Changes in absolute humidity are more important at mountain stations.

higher daytime humidities are even more pronounced when there is a green understory. Deciduous forests have only slight effects on humidity during their leafless period.

Two factors lessen the humidity difference between forest stands and forest openings. Overcast skies limit both heating and cooling, and drought conditions decrease the amount of moisture available for evaporation and transpiration.



Openings of up to about 20 yards in diameter do not have daytime relative humidities much different from under the canopy—except at the heated ground surface. As mentioned in the previous chapter, these openings serve as chimneys for convective airflow, and surface air is drawn into them from the surrounding forest. At night in small openings, the stagnation coupled with strong radiation can cause locally high humidities.



The daytime humidities in larger clearings are much like those in open country. If the airflow is restricted, however, temperatures may rise slightly above those at exposed stations, and humidities will be correspondingly lower. In the afternoon, these may range from 5 to 20 percent lower in the clearing than within a well-shaded forest. Night humidities are generally similar to those at exposed sites, usually somewhat higher than in the woods.

Relative humidity is normally higher under a closed canopy than in the open during the day, and lower at night.

Open forest stands have humidity characteristics somewhere between those of exposed sites and closed stands, depending on crown density. During dry weather, especially after prolonged dry spells, the differences in relative humidity between forested and open lands become progressively less.

This discussion of relative humidity variations has so far considered changes only within an air mass. As we will see later in the chapter on air masses and fronts, the amount of moisture in the air is one of the air-mass characteristics. Air masses originating over water bodies will have higher moisture contents than those originating over continents.

When a front passes, and a different air mass arrives, a change in absolute humidity can be expected. The change in relative humidity, however, will depend greatly on the air-mass temperature. A warm, dry air mass replacing a cool, moist one, or vice versa, may cause a large change in relative humidity. A cool, dry air mass replacing a warm, moist one, however, may actually have a higher relative humidity if its temperature is appreciably lower.

Along the west coast, when a lower marine layer is topped by a warm, dry, subsiding air mass, the inversion layer is actually the boundary between two very different air masses. Inland, where the inversion intersects the

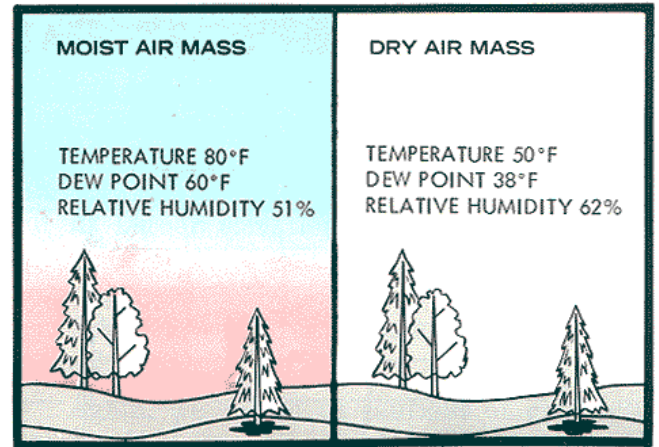

A cool, dry air mass may actually have a higher relative humidity than a warm, moist air mass.

coast ranges, very abnormal relative humidity patterns are found. In these inland areas, the inversion is usually higher in the day and lower at night; however, along the coastal lowlands, the reverse is usually true. Along the slopes of the adjacent mountains, some areas will be in the marine air during the day and in the dry, subsiding air at night. The relative humidity may begin to rise during the late afternoon and early evening and then suddenly drop to low values as dry air from aloft moves down the slopes. Abrupt humidity drops of up to 70 percent in the early evening have been observed.

SUMMARY

In this chapter we have considered atmospheric moisture in some detail. We have seen that moisture escapes into the atmosphere through evaporation from water bodies and soil, and through transpiration from vegetation. Atmospheric humidity is usually measured with a psychrometer and can be described in several ways. The dew-point temperature and the absolute humidity represent the actual moisture in the air, while the relative humidity indicates the degree of saturation at a given temperature.

We have also seen that absolute humidity varies in space and time for several reasons; however, relative humidity does not necessarily

change in the same manner, because relative humidity is very dependent upon air temperature. The temperature effect frequently overrides the absolute humidity effect; therefore, relative humidity usually varies inversely with temperature.

While temperature and moisture distributions in the layer of air near the ground are important in fire weather because of their influence on fuel moisture, the distributions of temperature and moisture aloft can critically influence the behavior of wildland fire in other ways. The first of these influences will be seen in the next chapter when we consider atmospheric stability.

Chapter 4

ATMOSPHERIC STABILITY

Wildfires are greatly affected by atmospheric motion and the properties of the atmosphere that affect its motion. Most commonly considered in evaluating fire danger are surface winds with their attendant temperatures and humidities, as experienced in everyday living. Less obvious, but equally important, are vertical motions that influence wildfire in many ways. Atmospheric stability may either encourage or suppress vertical air motion. The heat of fire itself generates vertical motion, at least near the surface, but the convective circulation thus established is affected directly by the stability of the air. In turn, the indraft into the fire at low levels is affected, and this has a marked effect on fire intensity.

Also, in many indirect ways, atmospheric stability will affect fire behavior. For example, winds tend to be turbulent and gusty when the atmosphere is unstable, and this type of airflow causes fires to behave erratically. Thunderstorms with strong updrafts and downdrafts develop when the atmosphere is unstable and contains sufficient moisture. Their lightning may set wildfires, and their distinctive winds can have adverse effects on fire behavior.

Subsidence occurs in larger scale vertical circulation as air from high-pressure areas replaces that carried aloft in adjacent low-pressure systems. This often brings very dry air from high altitudes to low levels. If this reaches the surface, going wildfires tend to burn briskly, often as briskly at night as during the day.

From these few examples, we can see that atmospheric stability is closely related to fire behavior, and that a general understanding of stability and its effects is necessary to the successful interpretation of fire-behavior phenomena.

ATMOSPHERIC STABILITY

Atmospheric stability was defined in chapter I as the resistance of the atmosphere to vertical motion. This definition and its explanation were based on the **parcel method** of analysis appropriate to a vertical temperature and moisture sounding through the troposphere.

This method employs some assumptions: (1) The sounding applies to an atmosphere at rest; (2) a small parcel of air in the sampled atmosphere, if caused to rise, does not exchange mass or heat across its boundary; and (3) rise of the parcel does not set its environment in motion. We learned that lifting under these conditions is **adiabatic lifting**.

Three characteristics of the sounding then determine the stability of the atmospheric layer

in which the parcel of air is embedded. These are: (1) The temperature lapse rate through the layer; (2) temperature of the parcel at its initial level; and (3) initial dew point of the parcel.

Adiabatically lifted air expands in the lower pressures encountered as it moves upward. This is a cooling process, and the rate of cooling with increase in altitude depends on whether or not the temperature reaches the dew point and consequent saturation. As long as the air remains unsaturated, it cools at the constant dry-adiabatic lapse rate of 5.5°F. per 1,000 feet of rise. Rising saturated air cools at a lesser rate, called the **moist-adiabatic** rate. This rate averages about 3°F. per 1,000 feet, but, as we will see later, it varies considerably.

STABILITY DETERMINATIONS

The degree of stability or instability of an atmospheric layer is determined by comparing its temperature lapse rate, as shown by a sounding, with the appropriate adiabatic rate. A temperature lapse rate less than the dryadiabatic rate of 5.5°F. per 1,000 feet for an unsaturated parcel is considered **stable**, because vertical motion is damped. A lapse rate greater than dry-adiabatic favors vertical motion and is **unstable**. In the absence of saturation, an atmospheric layer is **neutrally stable** if its lapse rate is the same as the dry-adiabatic rate. Under this particular condition, any existing vertical motion is neither damped nor accelerated.

In the case of a saturated parcel, the same stability terms apply. In this case, however, the comparison of atmospheric lapse rate is made with the moist-adiabatic rate appropriate to the temperature encountered.

Layers of different lapse rates of temperature may occur in a single sounding, varying from superadiabatic (unstable), usually found over heated surfaces, to dry-adiabatic (neutral), and on through inversions of temperature (very stable). In a saturated layer with considerable convective motion, the lapse rate tends to become moist-adiabatic.

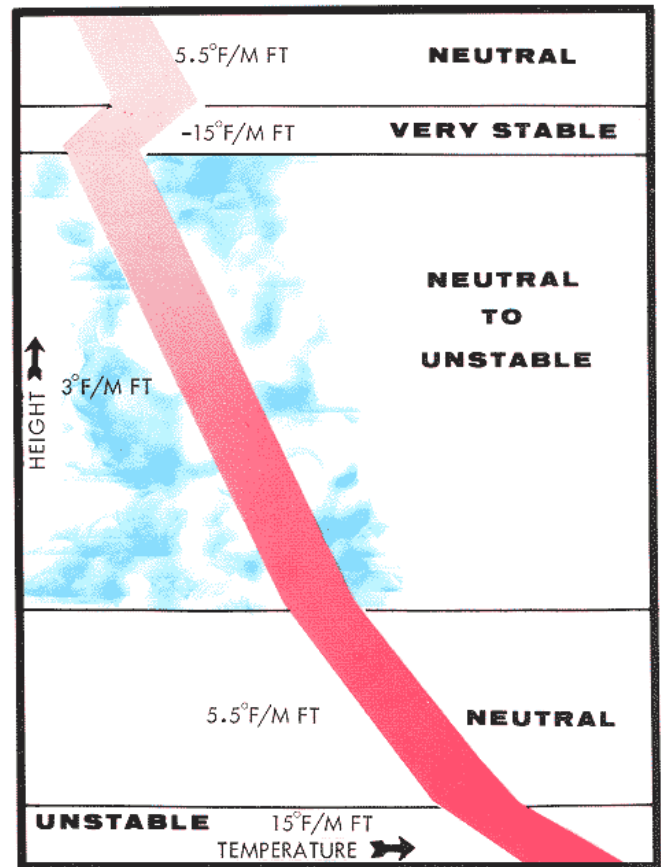

Atmospheric stability of any layer is determined by the way temperature varies through the layer and whether or not air in the layer is saturated.

The adiabatic process is reversible. Just as air expands and cools when it is lifted, so is it equally compressed and warmed as it is lowered. Hence, adiabatic processes and stability determinations for either upward or downward moving air parcels make use of the appropriate dry- or moist-adiabatic lapse rates. The temperature structure of the atmosphere is always complex. As mentioned above, the moist-adiabatic lapse rate is variable-not constant as is the dry-adiabatic rate.

Adiabatic Chart

To facilitate making stability determinations, therefore, meteorologists analyzing upper-air observations use a thermodynamic diagram called an **adiabatic chart** as a convenient tool for making stability estimates. The basic portion of the chart is a set of gridlines of temperature and pressure (or height) on which the measured temperature and moisture structure of the atmosphere can be plotted. The moisture is plotted as dew-point temperature. Also printed on the chart is a set of dry-adiabatic and a set of moist-adiabatic lines. By referring to these adiabats, the lapse rates of the various layers or portions of the atmosphere can be compared to the dry-adiabatic rate and the moist-adiabatic rate. In later chapters we will consider other ways in which the adiabatic chart is used.

Stability determinations from soundings in the atmosphere are made to estimate the subsequent motion of an air parcel that has been raised or lowered by an external force. In a stable atmosphere, the parcel will return to its original position when the force is removed; in an unstable atmosphere, the parcel will accelerate in the direction of its forced motion; and in a neutrally stable atmosphere, it will remain at its new position.

Stability of Unsaturated Air

We can illustrate use of the adiabatic chart to indicate these processes by plotting four hypothetical soundings on appropriate segments of a chart. We will first consider unsaturated air to which the constant dry-adiabatic lapse rate applies.

Assume for simplicity, that each of our four soundings has a lapse rate indicated dia-

The ADIABATIC CHART

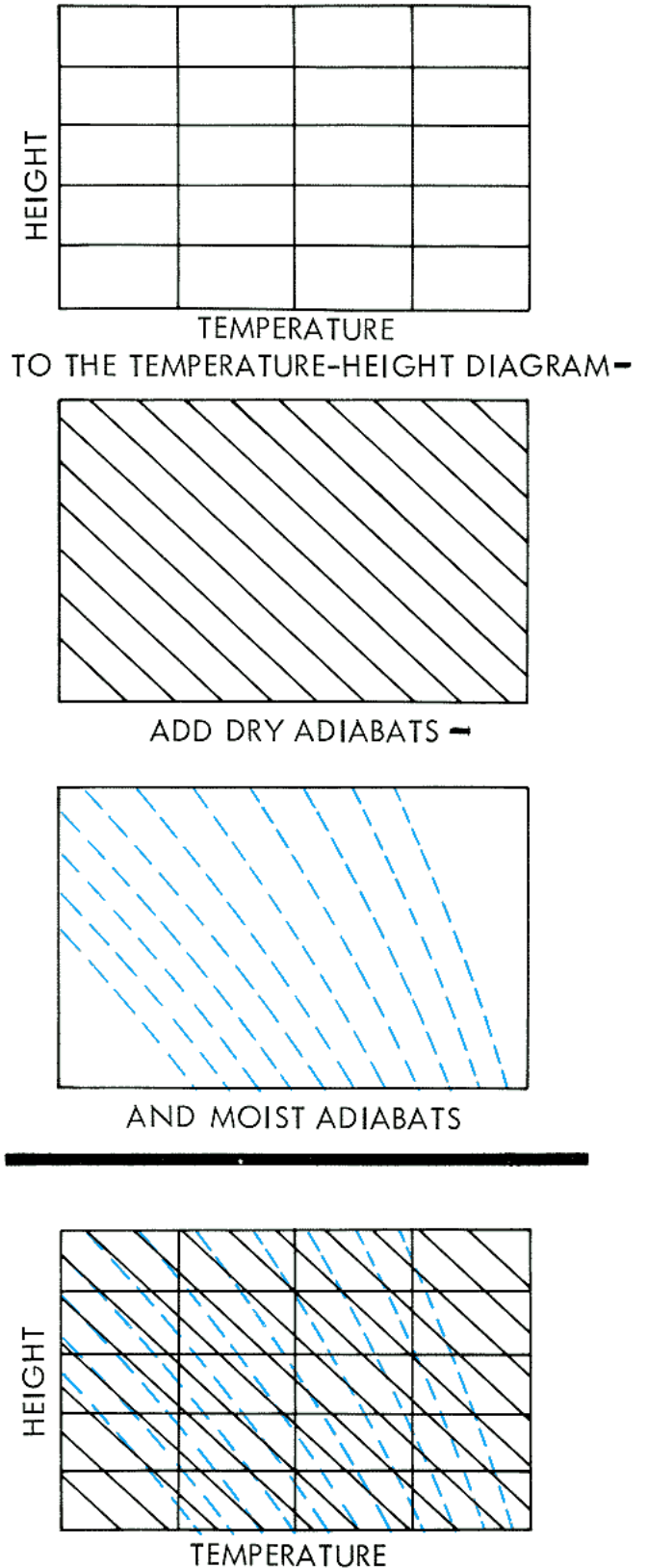

To determine stability, the meteorologist plots temperature and moisture soundings on an adiabatic chart and compares the lapse rates of various layers to the dry adiabats and moist adiabats.

grammatically by a solid black line. Note also in the accompanying illustration that each shows the temperature at 3,000 feet to be 50°F. For our purposes, let us select a parcel of air at this point and compare its temperature with that of its environment as the parcel is raised or lowered by external forces. If it remains unsaturated, the parcel will change in temperature at the dry-adiabatic rate indicated on the chart by red arrows.

The sounding plotted in (A) has a lapse rate of 3.5°F. per 1,000 feet. As the parcel is lifted and cools at its 5.5° rate, it thus becomes progressively colder and more dense than its environment. At 5,000 feet, for example, its temperature would be 39°F., but the temperature of the surrounding air would be 43°F. Gravity thus returns the parcel to its point of origin when the external force is removed. Moved downward, the parcel warms at the dry adiabatic rate and becomes warmer than its

environment. At 1,000 feet, for example, the parcel temperature would be 61°F., but the temperature of the environment would be only 57°F. Buoyancy forces the parcel back up to its original level. The damping action in either case indicates stability.

The parcel in (B) is initially in an inversion layer where the temperature increases at the rate of 3°F. per 1,000 feet of altitude. If the parcel is lifted, say 1,000 feet, its temperature will decrease 5.5°F., while the temperature of the surrounding air will be 3°F. higher. The parcel will then be 8.5°F. colder and will return to its original level as soon as the lifting force is removed. Similarly, a lowered parcel will become warmer than the surrounding air and will also return to its original level. Thus, inversions at any altitude are very stable.

Next, let us consider (C) where the parcel is embedded in a layer that has a measured lapse rate of 5.5°F. per 1,000 feet, the same as

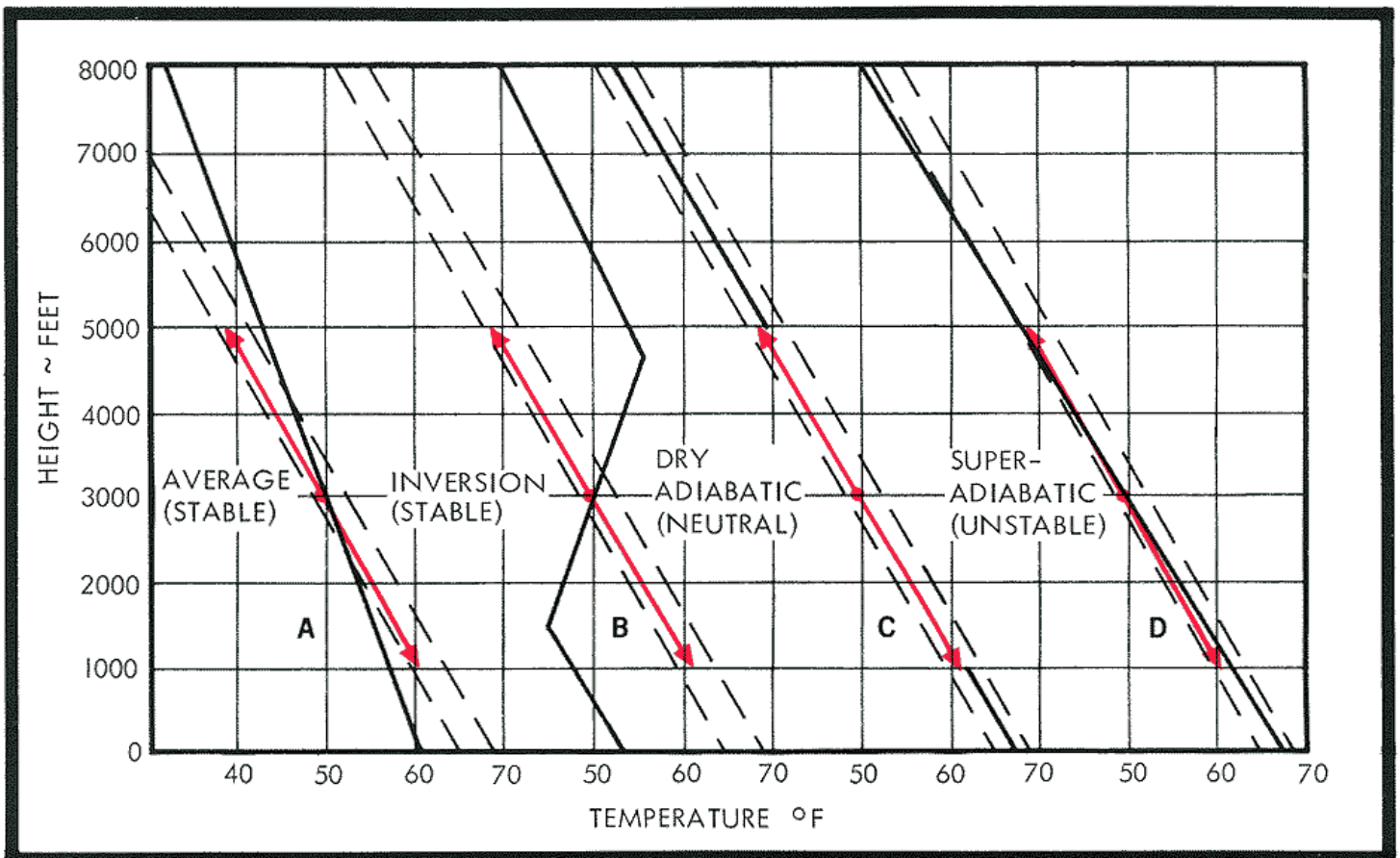

In unsaturated air, the stability can be determined by comparing the measured lapse rate (solid black lines) to the dry-adiabatic lapse rate (dashed black lines). The reaction of a parcel to lifting or lowering may be examined by comparing its temperature (red arrows for parcel initially at 3,000 feet and 50°F.) to the temperature of its environment.

the dry-adiabatic rate. If moved upward or downward in this layer, the parcel will change in temperature at the same rate as that of its environment and, therefore, will always be in temperature equilibrium with the surrounding air. The parcel will come to rest at its new level when external forces are removed. Technically, such a layer is neutrally stable, but we will see, after we consider an unstable case, that a neutrally stable layer is a potentially serious condition in fire weather.

In the last example (D) in unsaturated air, the plotted temperature lapse rate is 6°F. per 1,000 feet, which is greater than the dry adiabatic rate. Again, if our parcel is lifted, it will cool at the dry-adiabatic rate or 0.5° less per 1,000 feet than its surroundings. At an altitude of 5,000 feet, for example, the temperature of the parcel would be 39°F., while that of its surroundings would be 38°F. Thus, the parcel is warmer and less dense than the surrounding air, and buoyancy will cause it to accelerate upward as long as it remains warmer than the surrounding air. Moved downward, the parcel would similarly cool more rapidly than the surrounding air and accelerate downward. Hence, an atmospheric layer having a lapse rate greater than the dry-adiabatic rate is conducive to vertical motion and overturning, and represents an unstable condition.

Lapse rates greater than the dry-adiabatic rate, we learned in chapter 2, are called super-adiabatic. But since they are unstable, the air tends to adjust itself through mixing and overturning to a more stable condition. Super-adiabatic lapse rates are not ordinarily found in the atmosphere except near the surface of the earth on sunny days. When an unsaturated layer of air is mixed thoroughly, its lapse rate tends toward neutral stability.

The term "neutral" stability sounds rather passive, but we should be cautious when such a lapse rate is present. The temperature structure of the atmosphere is not static, but is continually changing. Any warming of the lower portion or cooling of the upper portion of a neutrally stable layer will cause the layer to become unstable, and it will then not only permit, but will assist, vertical motion. Such changes are easily brought about. Thus, we should consider the terms stable, neutral, and unstable in a relative, rather than an absolute,

sense. A stable lapse rate that approaches the dry-adiabatic rate should be considered relatively unstable.

Warming of the lower layers during the daytime by contact with the earth's surface or by heat from a wildfire will make a neutral lapse rate become unstable. In an atmosphere with a dry-adiabatic lapse rate, hot gases rising from a fire will encounter little resistance, will travel upward with ease, and can develop a tall convection column. A neutrally stable atmosphere can be made unstable also by advection; that is, the horizontal movement of colder air into the area aloft or warmer air into the area near the surface. Once the lapse rate becomes unstable, vertical currents are easily initiated. Advection of warm air aloft or cold air near the surface has the reverse effect of making the atmosphere more stable.

So far we have considered adiabatic cooling and warming and the degree of stability of the atmosphere only with respect to air that is not saturated. Rising air, cooling at the dry-adiabatic lapse rate, may eventually reach the dew-point temperature. Further cooling results in the condensation of water vapor into clouds, a change of state process that liberates the latent heat contained in the vapor. This heat is added to the rising air, with the result that the temperature no longer decreases at the dry-adiabatic rate, but at a lesser rate which is called the moist-adiabatic rate. On the average, as mentioned earlier, this rate is around 3°F. per 1,000 feet, but it varies slightly with pressure and considerably with temperature. The variation of the rate due to temperature may range from about 2°F. per 1,000 feet at very warm temperatures to about 5°F. per 1,000 feet at very cold temperatures. In warmer air masses, more water vapor is available for condensation and therefore more heat is released, while in colder air masses, little water vapor is available.

Stability of Saturated Air

Let us now consider a situation in which an air parcel is lifted and cooled until it reaches saturation and condensation. For this, we need to know both the initial temperature of the parcel and its dew-point temperature. This stability analysis of a sounding makes use of both

the dry-adiabatic and moist-adiabatic lines shown on the adiabatic chart. For this example, assume a sounding, plotted on the accompanying chart, showing a temperature lapse rate of 4.5°F. We will start with a parcel at sea level where the temperature is 80°F. and the dew point is 62°.

The 80°F. temperature and 62° dew point indicate that the parcel is initially unsaturated. As the parcel is lifted, it will cool at the dry-adiabatic rate until saturation occurs. The parcel dew-point temperature meanwhile decreases, as we learned in chapter 3, at the rate of 1°F. per 1,000 feet. If we draw a line on the adiabatic chart with a slope of -1°F. starting at the surface 62° dew point, we find that this line intersects the dry-adiabatic path of the parcel. The parcel temperature at this point is therefore at the dew point. The altitude of the point is thus at the **condensation level**.

In our example, condensation occurs at 4,000 feet above sea level at a temperature of 58°. The atmosphere is stable at this point because the parcel temperature is lower than that

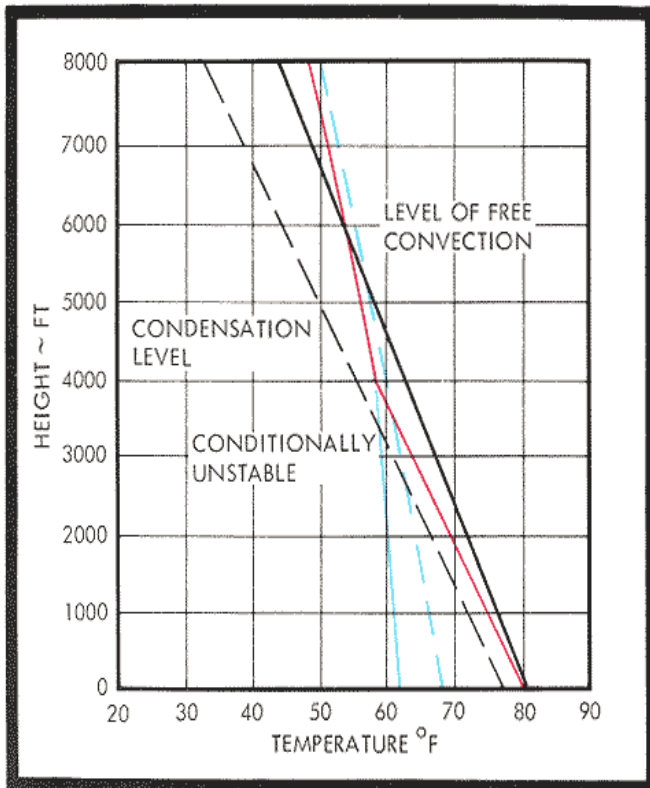

A lapse rate between the dry- and moist-adiabatic rates is conditionally unstable, because it would be unstable under saturated conditions but stable under unsaturated conditions. The temperature of a parcel raised from near the surface will follow the dry-adiabatic rate until saturation, then follow the moist-adiabatic rate. At the level where the parcel temperature exceeds the environment temperature, the parcel will begin free ascent.

shown by the sounding for the surrounding air. If the parcel is forced to rise above the condensation level, however, it then cools at the moist-adiabatic rate, in this case about 2.5°F. per 1,000 feet. At this rate of change, the parcel temperature will reach the temperature of the surrounding air at 6,000 feet. The level at which the parcel becomes warmer than the surrounding air is called the **level of free convection**. Above this level, the parcel will become buoyant and accelerate upward, continuing to cool at the moist-adiabatic rate, and no longer requiring an external lifting force.

Conditional Instability

The atmosphere illustrated by the above example, which has a lapse rate lying between the dry and moist adiabats, is said to be **conditionally unstable**. It is stable with respect to a lifted air parcel as long as the parcel remains unsaturated, but it is unstable with respect to a lifted parcel that has become saturated. In our example, the measured lapse rate of the layer is 4.5°F. This layer is, therefore, stable with respect to a lifted parcel as long as the parcel temperature follows the dry-adiabatic rate. It is unstable with respect to a lifted saturated parcel, because the temperature of the saturated parcel would follow the lesser moist-adiabatic rate, in this case about 2.5°F. per 1,000 feet.

A saturated parcel in free convection loses additional moisture by condensation as it rises. This, plus the colder temperature aloft, causes the moist-adiabatic lapse rate to increase toward the dry-adiabatic rate. The rising parcel will thus eventually cool to the temperature of the surrounding air where the free convection will cease. This may be in the vicinity of the tropopause or at some lower level, depending on the temperature structure of the air aloft.

Reliance on the parcel method of analyzing atmospheric stability must be tempered with considerable judgment. It is true that from the plotted temperature lapse rates on the adiabatic chart one can read differences between temperatures of parcels and the surrounding air. These are based, however, on the initial assumptions upon which the method is founded. One of these, for example, is that there is no

energy exchange between the parcel and the surrounding air. Vertical motion is, however, often accompanied by various degrees of mixing and attendant energy exchange, which makes this assumption only an approximation. The usual practice of plotting the significant turning points from sounding data and connecting them with straight lines

also detracts from precision. These are additional reasons for considering stability in a relative sense rather than in absolute terms.

The temperature of the parcel and the environment, and the dew-point temperature of the parcel used in this example, are summarized below;

Altitude	Environment temperature	Parcel temperature	Dew-point temperature
Sea level	80	80 *	62
2000'	71	69 * Dry-adiabatic lapse rate	60
4000' Condensation level	62	58 *	58
6000' Level of free convection	53	53 ~ Moist-adiabatic laps	53
8000'	44	48 ~	48

LAYER STABILITY

Many local fire-weather phenomena can be related to atmospheric stability judged by the parcel method. Equally important, however, are weather changes that occur when whole layers of the atmosphere of some measurable depth and of considerable horizontal extent are raised or lowered. Here again, it is necessary to employ some assumptions with respect to conservation of mass and energy, and the assumption that the adiabatic processes still apply. However, it is often possible to employ these concepts with somewhat greater confidence here than in the case of parcel-stability analyses. Let us first examine how the stability of an air layer changes internally as the layer is lifted or lowered.

When an entire layer of stable air is **lifted** it becomes increasingly **less stable**. The layer stretches vertically as it is lifted, with the top rising farther and cooling more than the bottom. If no part of the layer reaches condensation, the stable layer will eventually become dry-adiabatic. Let us consider an example:

We will begin with a layer extending from 6,000 to 8,000 feet with a lapse rate of 3.5°F. per 1,000 feet, and raise it until its base is at 17,000 feet. Because of the vertical stretching upon reaching lower pressures, the layer would be about 3,000 feet deep at its new altitude and the top would be at 20,000 feet. If the air in the layer remained unsaturated, its temperature would have decreased at the dry-adiabatic rate. The temperature of the top of the layer would have decreased 5.5×12 , or 66°F. The temperature of the bottom of the layer would have decreased 5.5×11 , or 60.5°F.

Originally, the difference between the bottom and top was 7°F., but after lifting it would be $66 - 60.5 = 5.5^\circ\text{F.}$ greater, or 12.5°F. Whereas the original lapse rate was 3.5°F. per 1,000 feet, it is $12.5 / 3$, or 4.2°F. per 1,000 feet after lifting. The layer has become less stable.

Occasionally, the bottom of a layer of air being lifted is more moist than the top and reaches its condensation level early in the lift-

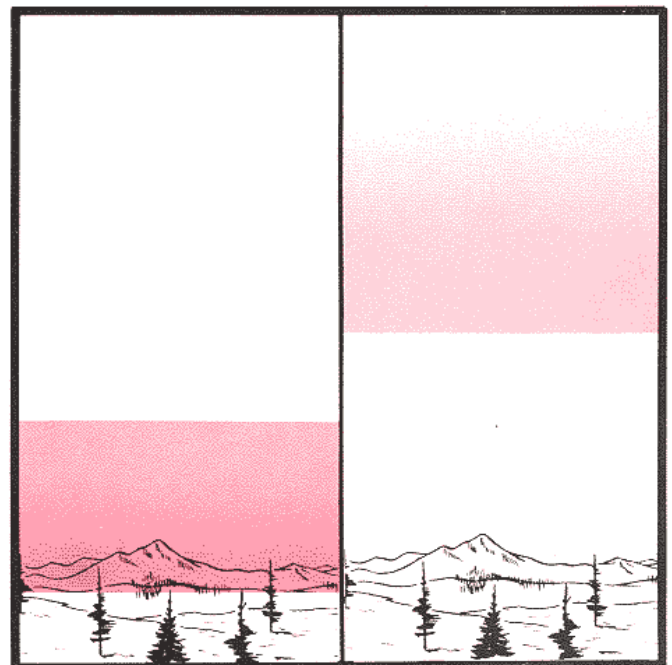

A lifted layer of air stretches vertically, with the top rising farther and cooling more than the bottom. If the layer is initially stable, it becomes increasingly less stable as it is lifted. Similarly, a subsidizing layer becomes more stable.

ing. Cooling of the bottom takes place at the slower moist-adiabatic rate, while the top continues to cool at the dry-adiabatic rate. The layer then becomes increasingly less stable at a rate faster than if condensation had not taken place.

A **descending** (subsiding) layer of stable air becomes **more stable** as it lowers. The layer compresses, with the top sinking more and

warming more than the bottom. The adiabatic processes involved are just the opposite of those that apply to rising air.

Since the lapse rate of the atmosphere is normally stable, there must be some processes by which air parcels or layers are lifted in spite of the resistance to lifting provided by the atmosphere. We will consider several such processes.

LIFTING PROCESSES

A common process by which air is lifted in the atmosphere, as is explained in detail in the next chapter, is **convection**. If the atmosphere remains stable, convection will be suppressed. But we have seen that surface heating makes the lower layers of the atmosphere unstable during the daytime. Triggering mechanisms are required to begin convective action, and they usually are present. If the unstable layer is deep enough, so that the rising parcels reach their condensation level, cumulus-type clouds will form and may produce showers or thunderstorms if the atmosphere layer above the con-

densation level is conditionally unstable. Wildfire also may be a source of heat which will initiate convection. At times, the fire convection column will reach the condensation level and produce clouds. Showers, though rare, have been known to occur.

Layers of air commonly flow in response to pressure gradients. In doing so, if they are lifted up and over mountains, they are subjected to what is called **orographic lifting**. This is a very important process along our north-south mountain ranges in the western regions and the Appalachians in the East, because the general airflow is normally from a westerly direction. If the air is initially stable, and if no condensation takes place, it sinks back to its original level after passing over a ridge. If it is neutrally stable, the air will remain at its new level after crossing the ridge. In an unstable atmosphere, air given an initial uplift in this way keeps on rising, seeking a like temperature level, and is replaced by sinking colder air from above. If the condensation level is reached in the lifting process, and clouds form, initially stable air can become unstable. In each case, the internal depth and lapse rate of the layer will respond as indicated above.

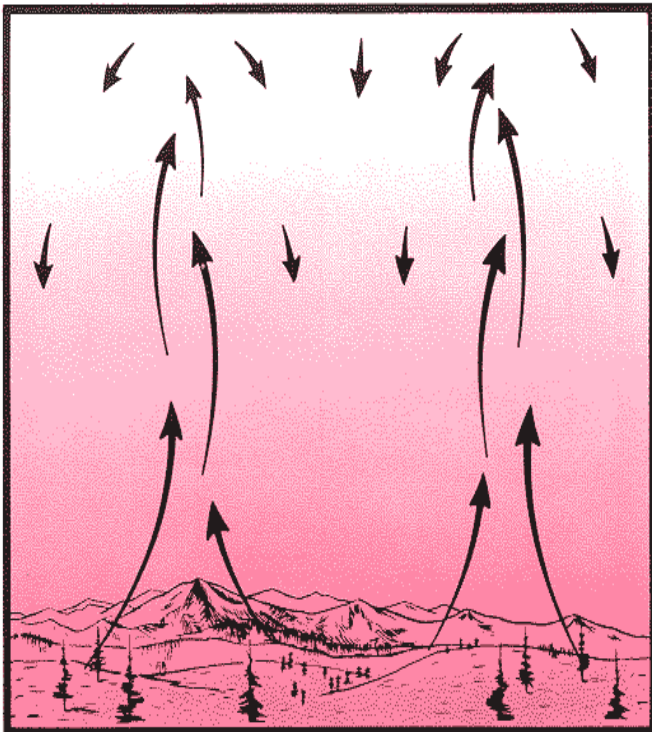

Convection is a process by which air is lifted in the atmosphere. Surface heating during the daytime makes the surface layer of air unstable. After its initial inertia is overcome, the air is forced upward by the more dense surrounding air.

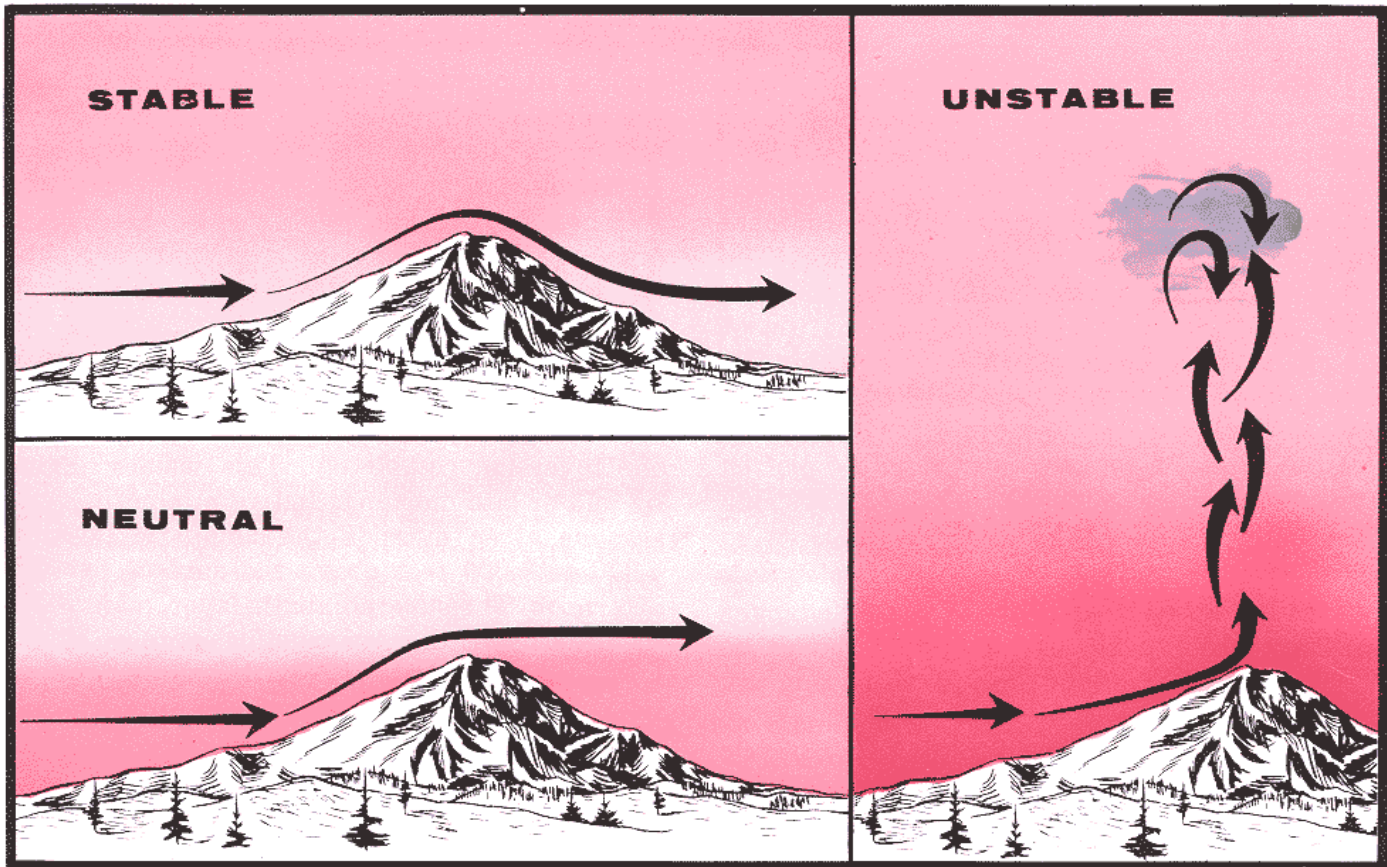

As air is lifted over mountain, the resulting airflow depends to some extent upon the stability of the air. These simple airflows may be complicated considerably by daytime heating and, in some cases, by wave motion.

Turbulence associated with strong winds results in mixing of the air through the turbulent layer. In this process, some of the air near the top of the layer is mixed downward, and that near the bottom is mixed upward, resulting in an adiabatic layer topped by an inversion. At times, the resultant cooling near the top of the layer is sufficient to produce condensation and the formation of stratus, or layerlike, clouds.

The airflow around surface **low-pressure** areas in the Northern Hemisphere is counter-clockwise and spirals inward. In the next chapter we will see why this is so, but here we will need to consider the inflow only because it produces upward motion in low-pressure areas. Airflow into a Low from all sides is called convergence. Now, the air must move. It is prevented from going downward by the earth's surface, so it can only go upward. Thus, low-pressure areas on a surface weather map are regions of upward motion in the lower atmosphere.

In surface **high-pressure** areas, the airflow is clockwise and spirals outward. This airflow away from a High is called **divergence**. The air must be replaced, and the only source is from aloft. Thus, surface high-pressure areas are regions of sinking air motion from aloft, or **subsidence**. We will consider subsidence in more detail later in this chapter.

Frequently, two or more of the above processes will act together. For example, the stronger heating of air over ridges during the daytime, compared to the warming of air at the same altitude away from the ridges, can aid orographic lifting in the development of deep convective currents, and frequently cumulus clouds, over ridges and mountain peaks. Similarly, orographic and frontal lifting may act together, and frontal lifting may combine with convergence around a Low to produce more effective upward motion.

DIURNAL AND SEASONAL VARIATIONS IN STABILITY

Stability frequently varies through a wide range in different layers of the atmosphere for various reasons. Layering aloft may be due to an air mass of certain source-region characteristics moving above or below another air mass with a different temperature structure. The inflow of warmer (less dense) air at the bottom, or colder (more dense) air at the top of an air mass promotes instability, while the inflow of warmer air at the top or colder air at the surface has a stabilizing effect. The changes in lapse rate of a temperature sounding plotted on an adiabatic chart frequently correspond closely to the layering shown in upper-wind measurements.

At lower levels, stability of the air changes with surface heating and cooling, amount of cloud cover, and surface wind all acting together. We will consider first the changes in stability that take place during a daily cycle and the effects of various factors; then we will consider seasonal variations.

Diurnal changes in surface heating and cooling, discussed in chapter 2, and illustrated in particular on pages 27, 28, produce daily changes in stability, from night inversions to daytime superadiabatic lapse rates, that are common over local land surfaces. During a typical light-wind, fair-weather period, radiation cooling at night forms

a stable inversion near the surface, which deepens until it reaches its maximum development at about daybreak. After sunrise, the earth and air near the surface begin to heat, and a shallow superadiabatic layer is formed. Convective currents and mixing generated in this layer extend up to the barrier created by the inversion. As the day progresses, the unstable superadiabatic layer deepens, and heated air mixing upward creates an adiabatic layer, which eventually eliminates the inversion completely. This usually occurs by mid or late morning. Active mixing in warm seasons often extends the adiabatic layer to 4,000 or 5,000 feet above the surface by midafternoon. The superadiabatic layer, maintained by intense heating, is usually confined to the lowest few hundreds of feet, occasionally reaching 1,000 to 2,000 feet over bare ground in midsummer.

As the sun sets, the ground cools rapidly under clear skies and soon a shallow inversion is formed. The inversion continues to grow from the surface upward throughout the night as surface temperatures fall. The air within the inversion becomes increasingly stable. Vertical motion in the inversion layer is suppressed, though mixing may well continue in the air above the inversion. This mixing allows radia-

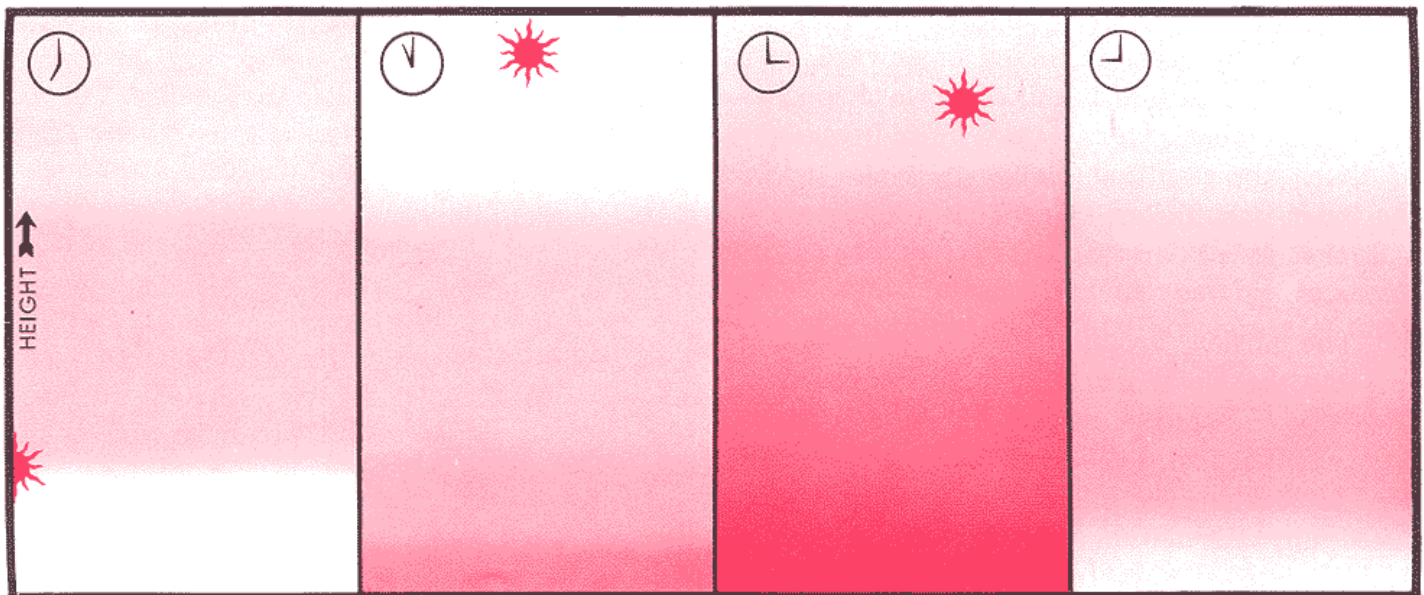

On a typical fair-weather summer day, stability in the lower atmosphere goes through a regular cycle. Cooling at night near the surface stabilizes the layer of air next to the ground. Warming during the daytime makes it unstable.

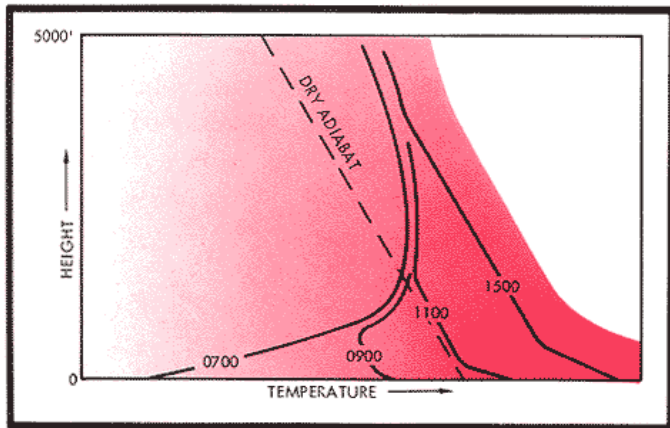

A night surface inversion (0700) is gradually eliminated by surface heating during the forenoon of a typical clear summer day. A surface superadiabatic layer and a dry-adiabatic layer above deepen until they reach their maximum depth about mid afternoon.

tional cooling above the inversion to lower temperatures in that layer only slightly during the night.

This diurnal pattern of nighttime inversions and daytime superadiabatic layers near the surface can be expected to vary considerably. Clear skies and low air moisture permit more intense heating at the surface by day and more intense cooling by radiation at night than do cloudy skies. **The lower atmosphere tends to be more unstable on clear days and more stable on clear nights.**

Strong winds diminish or eliminate diurnal variations in stability near the surface. Turbulence associated with strong wind results in mixing, which tends to produce a dry-adiabatic lapse rate. Mechanical turbulence at night prevents the formation of surface inversions, but it may produce an inversion at the top of the mixed layer. During the day, thermal turbulence adds to the mechanical turbulence to produce effective mixing through a relatively deep layer. Consequently, great instability during the day, and stability at night occur when surface winds are light or absent.

Stability in the lower atmosphere varies locally between surfaces that heat and cool at different rates. Thus, dark-colored, barren, and rocky soils that reach high daytime temperatures contribute to strong daytime instability and, conversely, to strong stability at night. Areas recently blackened by fire are subject to about the maximum diurnal variation in surface temperature

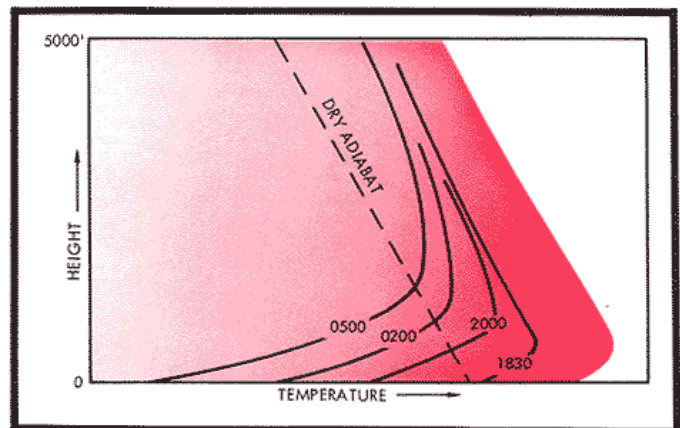

The ground cools rapidly after sundown and a shallow surface inversion is formed (1830). This inversion deepens from the surface upward during the night, reaching its maximum depth just before sunrise (0500).

and the resulting changes in air stability. Vegetated areas that are interspersed with openings, outcrops, or other good absorbers and radiators have very spotty daytime stability conditions above them.

Topography also affects diurnal changes in the stability of the lower atmosphere. Air in mountain valleys and basins heats up faster during the daytime and cools more rapidly at night than the air over adjacent plains. This is due in part to the larger area of surface contact, and in part to differences in circulation systems in flat and mountainous topography. The amount of air heating depends on orientation, inclination, and shape of topography, and on the type and distribution of ground cover. South-facing slopes reach higher temperatures and have greater instability above them during the day than do corresponding north slopes. Both cool about the same at night.

Instability resulting from superheating near the surface is the origin of many of the important convective winds which we will discuss in detail in chapter 7. On mountain slopes, the onset of daytime heating initiates upslope wind systems. The rising heated air flows up the slopes and is swept aloft above the ridge tops in a more-or-less steady stream.

Over level ground, heated surface air, in the absence of strong winds to disperse it, can remain in a layer next to the ground until it is disturbed. The rising air frequently spirals upward in the form of a whirlwind or dust

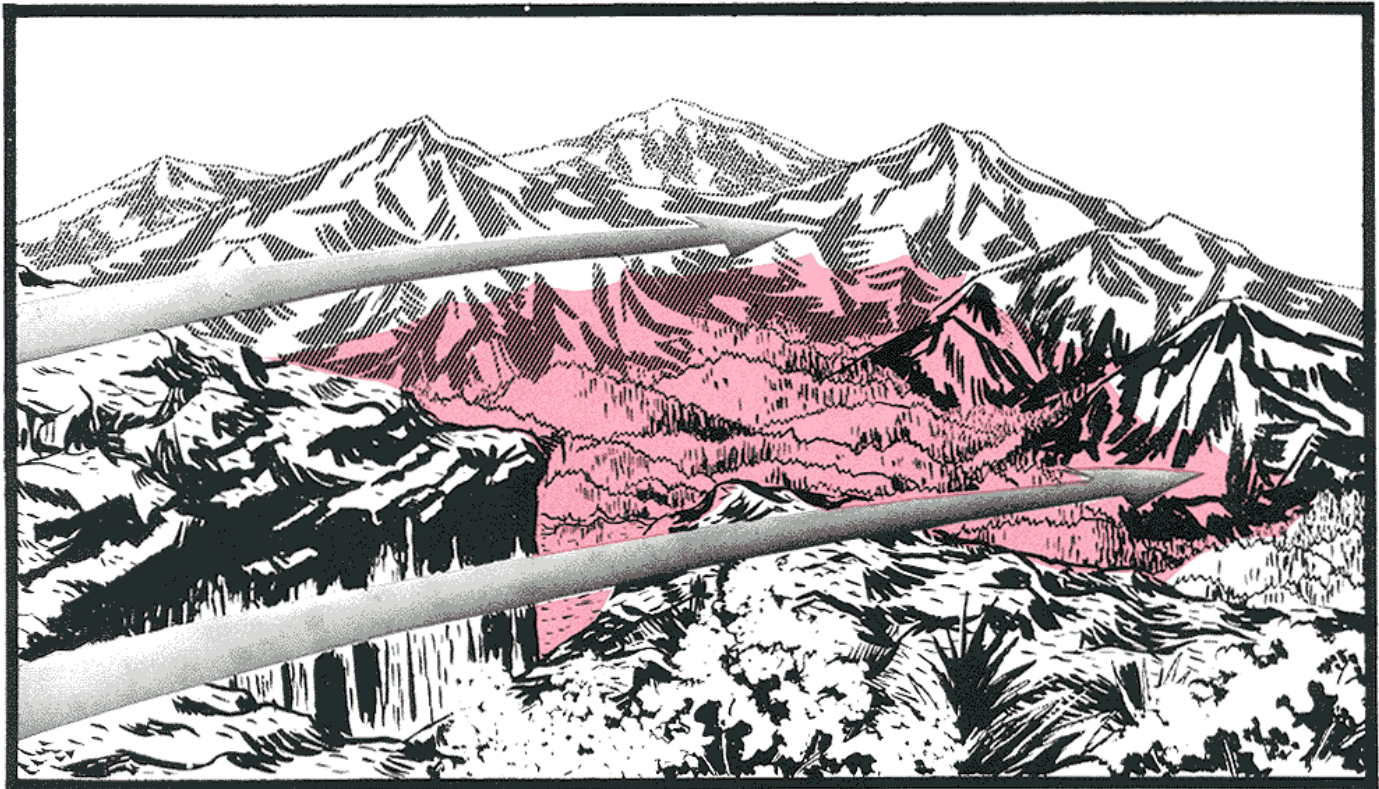

Strong heating may produce a pool of superheated air in poorly ventilated basins. If upper winds are unable to provide the triggering mechanism needed to overcome inertia and release the instability in this superadiabatic layer, a potentially explosive fire weather situation develops.

devil. In other cases, it moves upward as intermittent bubbles or in more-or-less continuous columns. Pools of superheated air may also build up and intensify in poorly ventilated valleys to produce a highly unstable situation. They persist until released by some triggering mechanism which overcomes inertia, and they may move out violently.

The amount of solar radiation received at the surface during the summer is considerably greater than in the winter. As explained in chapter 1, this is due to the difference in solar angle and the duration of sunshine. Temperature profiles and stability reflect **seasonal variation** accordingly. In the colder months, inversions become more pronounced and more persistent, and superadiabatic lapse rates occur only occasionally.

In the summer months, superadiabatic conditions are the rule on sunny days. Greater variation in stability from day to day may be expected in the colder months because of the greater variety of air masses and weather situations that occur during this stormy season.

In addition to the seasonal effects directly caused by changes in solar radiation, there is also an important effect that is caused by the lag in heating and cooling of the atmosphere as a whole. The result is a predominance of cool air over warming land in the spring, and warm air over cooling surfaces in the fall. Thus, the steepest lapse rates frequently occur during the spring, whereas the strongest inversions occur during fall and early winter.

SUBSIDENCE

Air that rises in the troposphere must be replaced by air that sinks and flows in beneath that which rises. Local heating often results in small-scale updrafts and downdrafts in the same vicinity.

On a larger scale, such as the up-flow in low-pressure systems, adjacent surface high-pressure systems with their divergent flow normally supply the replacement air. The

outflow at the surface from these high-pressure areas results in sinking of the atmosphere above them. **This sinking from aloft is the common form of subsidence.**

The sinking motion originates high in the troposphere when the high-pressure systems are deep. Sometimes these systems extend all the way from the surface up to the tropopause. Deep high-pressure systems are referred to as **warm Highs**, and subsidence through a deep layer is characteristic of warm Highs.

Subsidence occurs in these warm high-pressure systems as part of the return circulation compensating for the large upward transport of air in adjacent low-pressure areas. If the subsidence takes place without much horizontal mixing, **air from the upper troposphere may reach the surface quite warm and extremely dry.**

For example, the saturation absolute humidity of air in the upper troposphere with a temperature of -50° to -60°F . is less than 0.02 pounds per 1,000 cubic feet. In lowering to the surface, this air may reach a temperature of 70°F . or higher, where saturation would represent 1.15 pounds or more of water per 1,000 cubic feet. If no moisture were added to the air in its descent, the relative humidity would then be less than 2 percent.

Subsiding air may reach the surface at times with only very little external modification or addition of moisture. Even with considerable gain in moisture, the final relative humidity can be quite low. The warming and drying of air sinking adiabatically is so pronounced that saturated air, sinking from even the middle troposphere to near sea level, will produce relative humidities of less than 5 percent. Because of the warming and drying, subsiding air is characteristically very clear and cloudless.

Subsidence in a warm high-pressure system progresses downward from its origin in the upper troposphere. In order for the sinking motion to take place, the air beneath must flow outward, or diverge. Thus, **horizontal divergence** is an integral part of subsidence in the troposphere. The descent rate is observed by following the progress of the subsidence inversion on successive upper-air soundings.

The accompanying chart shows a simplified illustration of the subsidence inversion on 3

successive days. The temperature lapse rate in the descending layer is nearly dry-adiabatic, and its bottom surface is marked by a temperature inversion. Two features, a temperature inversion and a marked decrease in moisture, identify the base of a subsiding layer. Below the inversion, there is an abrupt rise in the moisture content of the air.

The rate of descent of subsiding air varies widely. It is typically fastest at higher levels and becomes progressively slower near the surface. It is commonly about 5,000 feet in 6 hours around the 30,000-foot level, and about 500 feet in 6 hours at the 6,000-foot level.

Frequently, the subsiding air seems to lower in successive stages. When this happens, a sounding will show two or more inversions with very dry air from the top down to the lowest inversion. This air may be drier than can be measured with standard sounding equipment.

Subsiding air seldom reaches the surface as a broad layer. Often, it sinks to the lower troposphere and then stops. We need, therefore, to consider ways in which the dry air no longer lowering steadily over a broad area can affect the surface.

Along the west coast in summer we generally find a cool, humid advected marine layer 1,000-2,000 feet thick with a warm, dry subsiding layer of air above it. This subsidence inversion is usually low enough so that coastal mountains extend up into the dry air. The higher topographic elevations will experience warm temperatures and very low humidities both day and night. Some mixing of moisture upward along the slopes usually occurs during the daytime with upslope winds.

As the marine layer moves inland from the coast during clear summer days, it is subjected to intensive heating and becomes warmer and warmer until finally the subsidence inversion is wiped out. The temperature lapse rate from the surface to the base of the dry air, or even higher, becomes dry-adiabatic. Then, convective currents can be effective in bringing dry air from aloft down to the surface and mixing the more moist air from near the surface to higher levels.

This process can well take place in other regions when the subsidence inversion reaches low-enough levels so it can be eliminated by

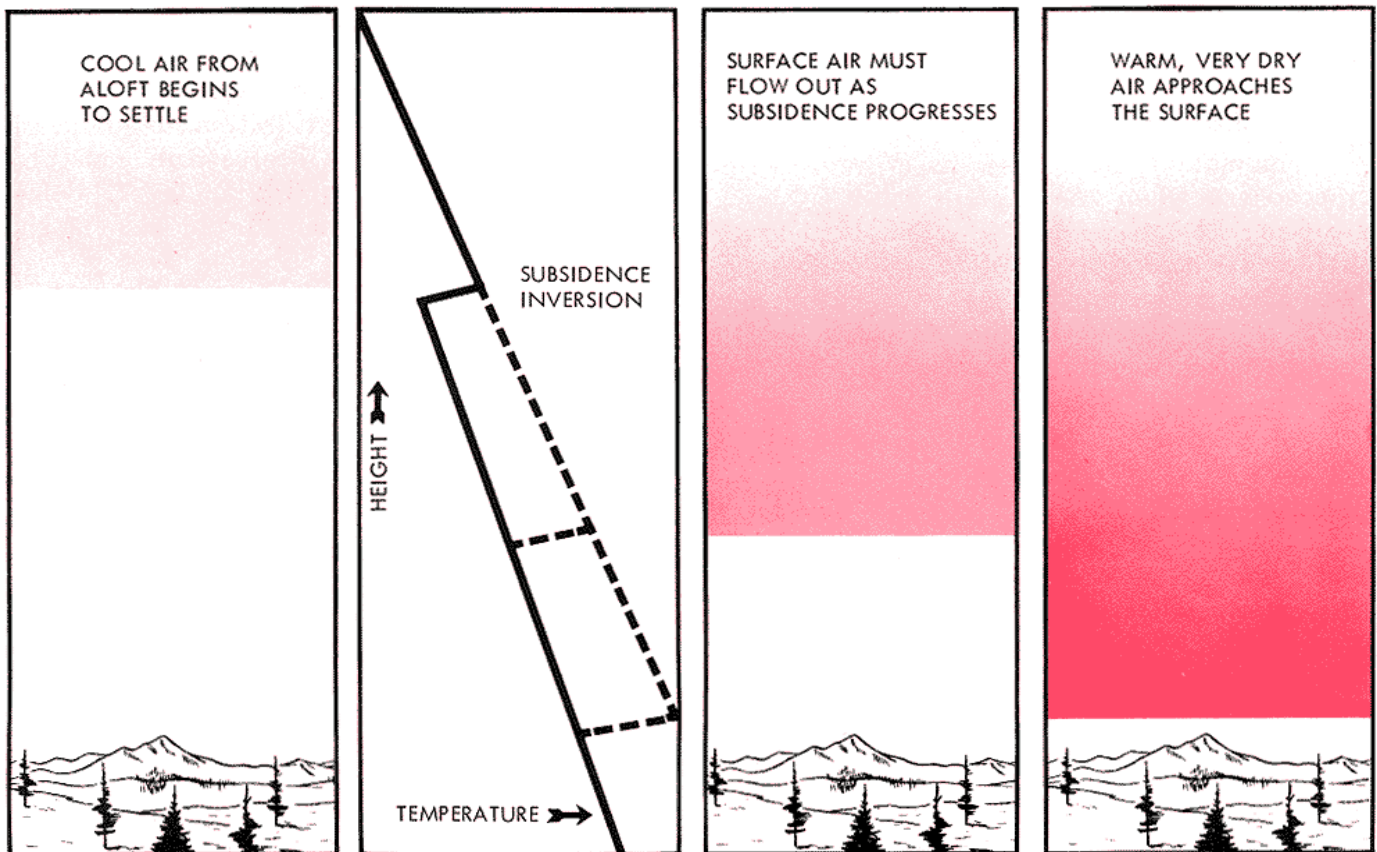

The descent of a subsidence inversion may be followed on successive soundings, as shown by dashed lines. As the more humid surface air flows outward, the drier air aloft is allowed to sink and warm adiabatically.

surface daytime heating, The inversion will be wiped out only in local areas where surface heating is intense enough to do the job. If the heating is not sufficient to eliminate the inversion, the warm, dry air cannot reach the surface by convection. Convective currents in the layer beneath the inversion may be effective in eating away the base of the inversion and mixing some of the dry air above with the more humid air below. This process will warm and dry the surface layer somewhat, but humidities cannot reach the extremely low values characteristic of a true subsidence situation.

Another method by which dry, subsiding air may reach the surface is by following a sloping downward path rather than a strictly vertical path. A vertical sounding may show that the subsiding air is much too warm to reach the surface by sinking vertically, because the layer beneath it is cooler and denser. However, if surface air temperatures are warmer downstream, the subsiding air can sink

dry-adiabatically to lower levels as it moves downstream and may eventually reach the surface. This process is most likely to occur around the eastern and southern sides of a high-pressure area where temperatures increase along the air trajectory. By the time the sinking air reaches the surface, it is likely to be on the south, southwest, or even west side of the High.

Subsiding air may reach the surface in a dynamic process through the formation of mountain waves when strong winds blow at right angles to mountain ranges. Waves of quite large amplitude can be established over and on the leeward side of ranges. Mountain waves can bring air from great heights down to the surface on the lee side with very little external modification. These waves may also be a part of the foehn-wind patterns, which we will touch off only briefly here since they will be treated in depth in chapter 6.

In the mountain areas of the West, **foehn winds**, whether they are the **chinook** of the

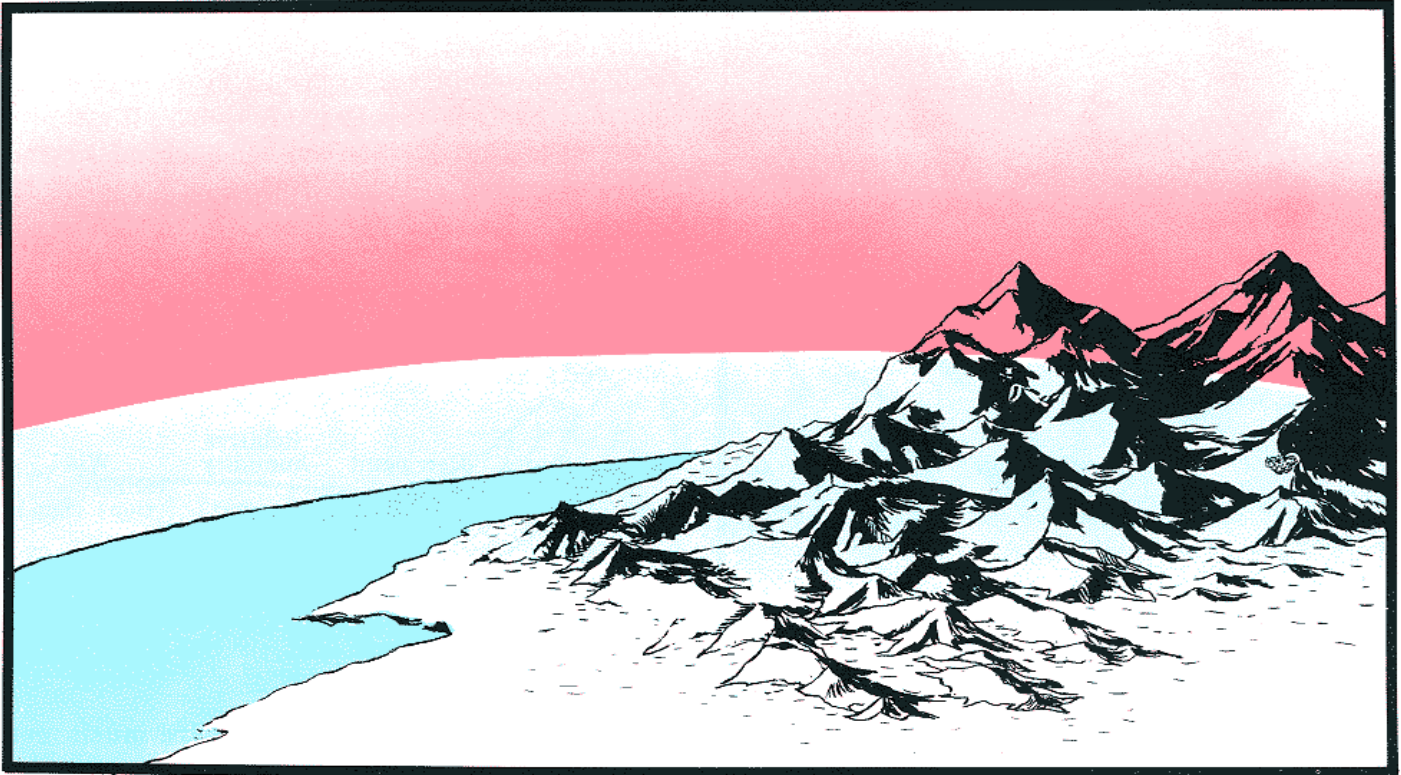

Along the west coast in summer, high elevations in the coastal mountains, extending into the dry, subsiding air have warm temperatures and very low humidities both day and night, while lower coastal slopes are influenced by the cool, humid marine layer.

eastern slopes of the Rockies, the **Santa Ana** of southern California, or the **Mono** and northeast wind of central and northern California, are all associated with a high-pressure area in the Great Basin. A **foehn** is a wind flowing down the leeward side of mountain ranges where

air is forced across the ranges by the prevailing pressure gradient.

Subsidence occurs above the High where the air is warm and dry. The mountain ranges act as barriers to the flow of the lower layer of air so that the air crossing the ranges comes

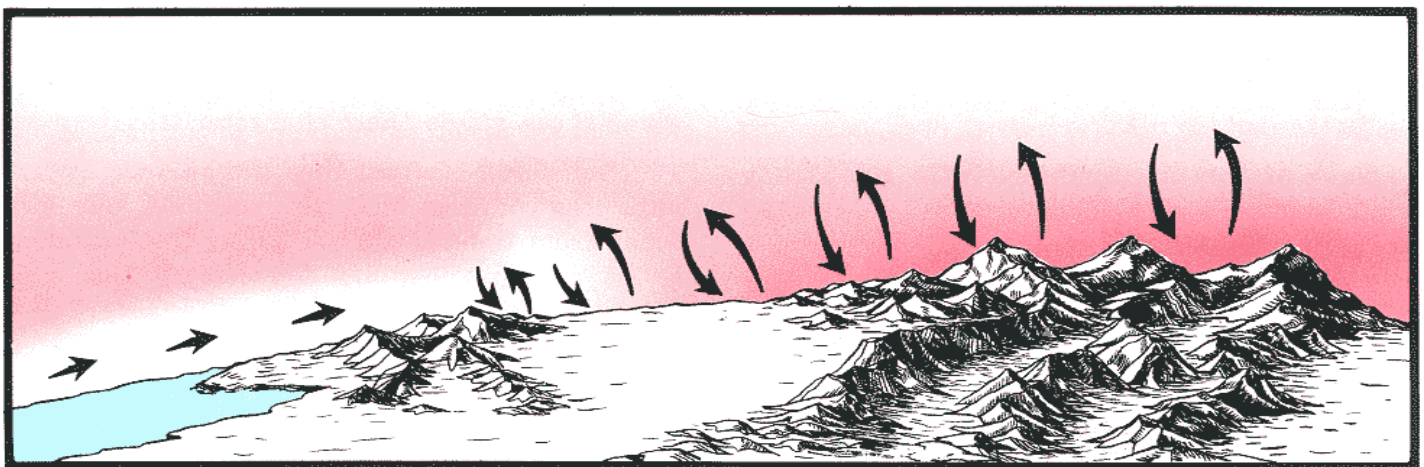

Heating of the west coast marine layer as it moves inland on clear summer days may destroy the subsidence inversion. As a dry-adiabatic lapse rate is established, convective mixing can bring dry air from aloft down to the surface, and carry more moist air from the surface to higher levels.

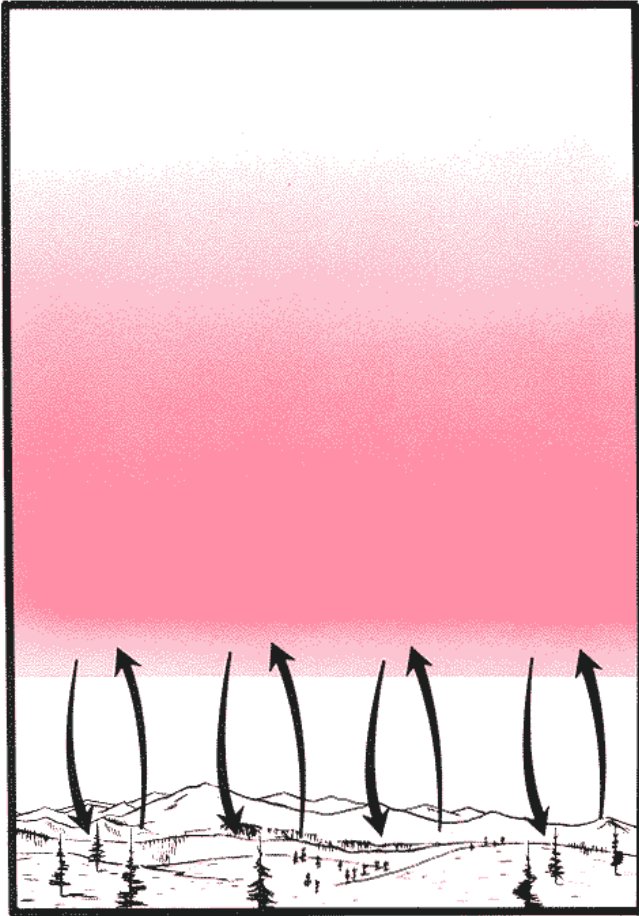

Daytime convective currents may eat away the base of a subsidence inversion and mix some of the dry air above with the more humid air below. This process will warm and dry the surface layer slightly, but humidities cannot reach extremely low values unless the subsiding air reaches the surface.

from the dryer layer aloft. If the pressure gradient is favorable for removing the surface air on the leeward side of the mountain, the dry air from aloft is allowed to flow down the lee slopes to low elevations. **The dryness and warmth of this air combined with the strong wind flow produce the most critical fire-weather situations known anywhere.**

Mountain waves, most common and strongest in the West, are also characteristic of flow over eastern and other mountain ranges. When they occur with foehn winds, they create a very spotty pattern. The strongest winds and driest air are found where the mountain waves dip down to the surface on the leeward side of the mountains.

An example of a severe subsidence condition associated with chinook winds, and in which mountain waves probably played an important part, is the Denver, Colo., situation of December 1957. On December 9, chinook winds were reported all along the east slope of the Rocky Mountains in Wyoming and Colorado. Surface relative humidity at Denver remained at 3 percent or below from noon until midnight that day. The Denver observation at 1900 hours showed:

Temperature	Dew point	Relative humidity	Wind
(°F.)	(°F.)	(Percent)	(Direction) (m.p.h.)
60	-29	1	W 22

The extremely low dew point indicates that the air must have originated in the high troposphere.

Cases of severe subsidence are much more frequent in the western half of the country than in the eastern regions. Most of the Pacific coast area is affected in summer by the deep semi-permanent Pacific High. This provides a huge reservoir of dry, subsiding air which penetrates the continent in recurring surges to produce long periods of clear skies and dry weather. Fortunately, marine air persists much of the time in the lower layer along the immediate coast and partially modifies the subsiding air before it reaches the surface.

In the fall and winter months, the Great Basin High is a frequent source of subsiding air associated with the foehn winds, discussed above. It is the level of origin of this air that gives these winds their characteristic dryness.

Subsiding air reaching the surface is perhaps less common in eastern regions, but does occur from time to time. Usually the subsiding air is well modified by convection. But subsidence is often a factor in the severe fire weather found around the periphery of Highs moving into the region east of the Rockies from the Hudson Bay area or Northwest Canada mostly in spring and fall. It also occurs during summer and early fall periods of drought, when the Bermuda High extends well westward into the country.

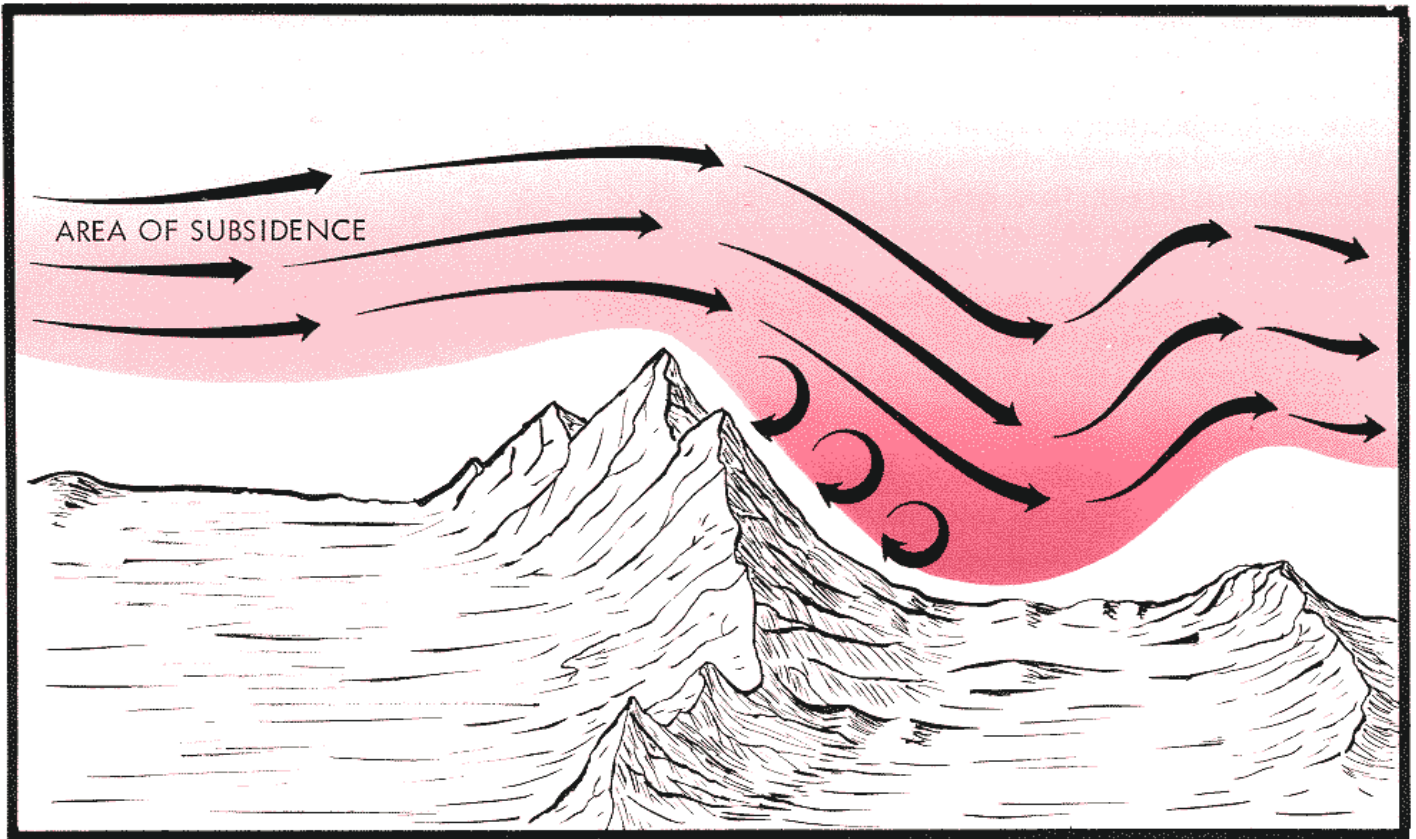

Subsiding air above a High windward of a mountain range may be carried with the flow aloft and brought down to the leeward surface, with little modification, by mountain waves.

LOCAL INDICATORS OF STABILITY

The continent-wide network of weather stations that make regular upper-air soundings gives a broad general picture of the atmospheric structure over North America. These soundings show the major pressure, temperature, and moisture patterns that promote stability, instability, or subsidence, but they frequently do not provide an accurate description of the air over localities at appreciable distances from the upper-air stations. We need, therefore, to supplement these observations with local measurements or with helpful indicators.

At times, it may be possible to take upper-air observations with portable instruments in fixed-wing aircraft or helicopters. In mountainous country, temperature and humidity measurements taken at mountaintop and valley-bottom stations provide reasonable estimates of the lapse rate and moisture conditions in the air layer between the two levels. In areas where inversions form at night, similar measurements indicate the strength of the inversion. The heights of surface or low-level

inversions can be determined by traversing slopes that extend through them. The height at which rising smoke flattens out may indicate the base of a low-level inversion. The tops of clouds in the marine layer along the Pacific coast coincide with the base of the subsidence inversion. The height of the cloud tops provides a good estimate of the height of the inversion.

Other visual indicators are often quite revealing. Stability in the lower layers is indicated by the steadiness of the surface wind. A steady wind is indicative of stable air. Gusty wind, except where mechanical turbulence is the obvious cause, is typical of unstable air. Dust devils are always indicators of instability near the surface. Haze and smoke tend to hang near the ground in stable air and to disperse upward in unstable air.

Cloud types also indicate atmospheric sta-

bility at their level. Cumulus-type clouds contain vertical currents and therefore indicate instability. The heights of cumulus clouds indicate the depth and intensity of the instability. The absence of cumulus clouds, however, does not necessarily mean that the air is stable. Intense summer heating can produce strong convective currents in the lower atmosphere, even if the air is too dry for condensation and cloud formation. Generally, though, the absence of clouds is a good indication that subsidence is occurring aloft. Even if scattered cumulus clouds are present during the day and are not developing vertically to any great extent, subsidence very likely is occurring above

the cumulus level. Stratus-type cloud sheets indicate stable layers in the atmosphere.

In mountainous country, where fire lookouts on high peaks take observations, a low dew-point temperature may provide the only advance warning of subsidence. Hygrothermograph records and wet- and dry-bulb temperature observations show a sharp drop in relative humidity with the arrival of subsiding air at the mountaintop. Early morning dew-point temperatures of 20°F. or lower in summer or early fall may signal the presence of subsiding air, and provide a warning of very low humidities at lower elevations in the afternoon.

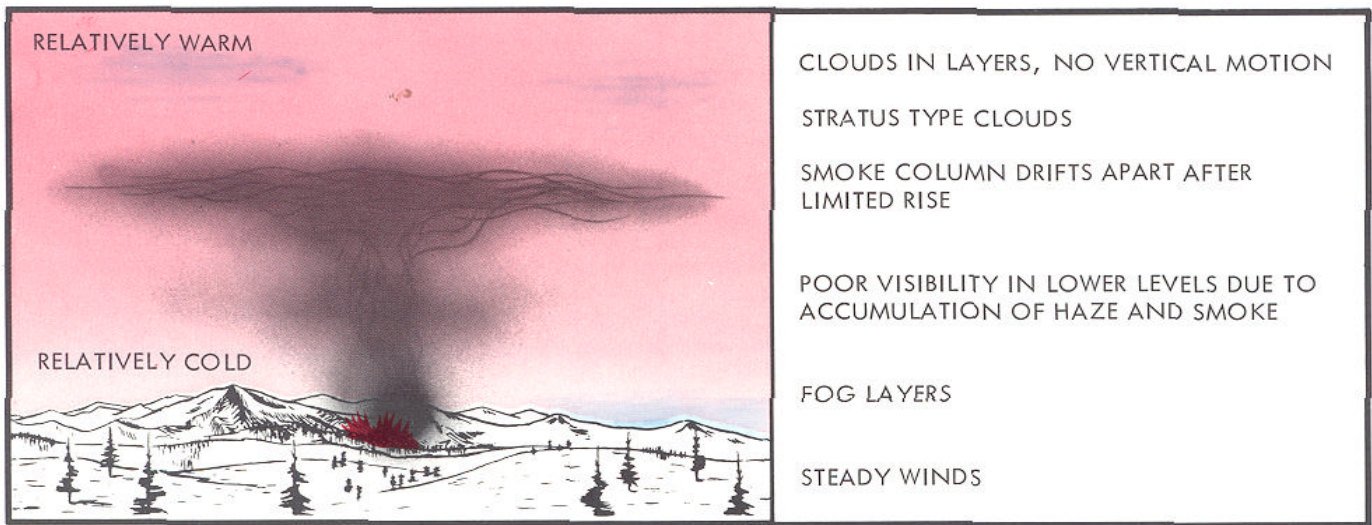

Visible indicator of a stable atmosphere.

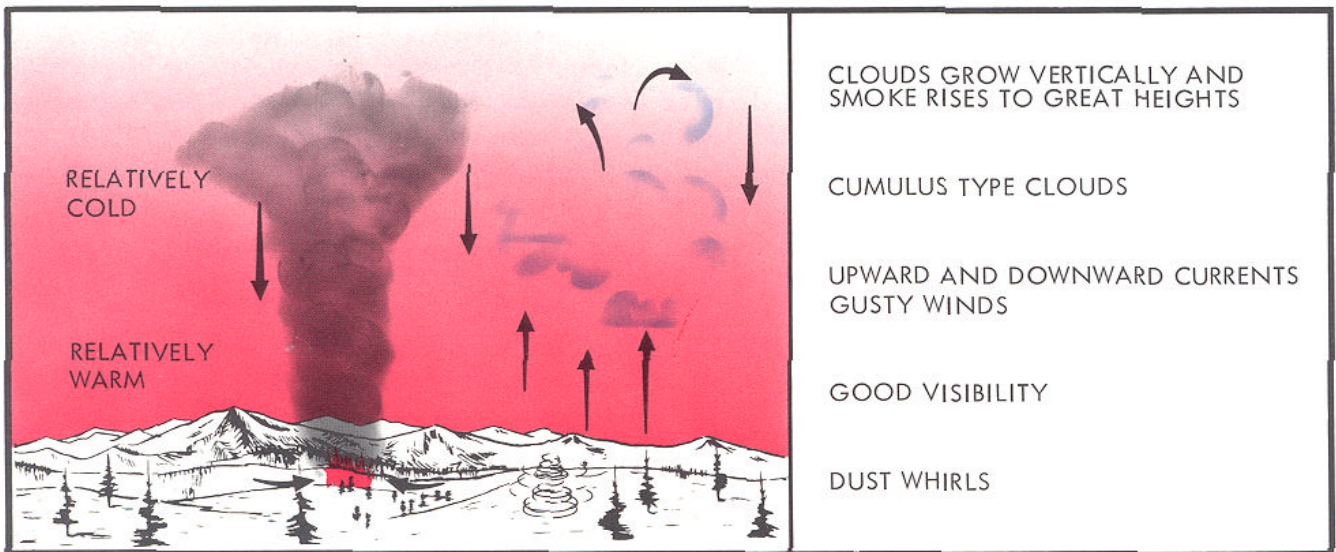

Visible indicator of a stable atmosphere.

SUMMARY

In this chapter we have seen how the distribution of temperature vertically in the troposphere influences vertical motion. A large decrease of temperature with height indicates an unstable condition which promotes up and down currents. A small decrease with height indicates a stable condition which inhibits vertical motion. Where the temperature increases with height, through an inversion, the atmosphere is extremely stable.

Between stable and unstable lapse rates we may have a conditionally unstable situation in which the atmosphere's stability depends upon whether or not the air is saturated. During condensation in saturated air, heat is released which warms the air and may produce instability; during evaporation, heat is absorbed and may increase stability.

Atmospheric stability varies with local heating, with wind speed, surface characteristics, warm- and cold air advection, and many

other factors. We can use type of cloud, wind-flow characteristics, occurrence of dust devils, and other phenomena as indicators of stability.

Subsidence is the gradual lowering of a layer of air over a broad area. When it begins at high levels in the troposphere, the air, which has little initial moisture, becomes increasingly warmer with resulting lower relative humidity as it approaches the surface. If some mechanism is present by which this warm, dry air can reach the surface, a very serious fire situation can result.

The first four chapters have been concerned with basic physical laws and with the statics of the atmosphere-its temperature and moisture and their distribution both horizontally and vertically, and to some extent its pressure. In the next chapter, we will consider pressure distributions more thoroughly and see how they are related to atmospheric circulation.

Chapter 5

GENERAL CIRCULATION

Local fire-weather elements-wind, temperature, moisture, and stability-respond continually to the varying patterns of pressure systems and to the changing properties of huge masses of air moving in generally predictable circulations over the earth's surface. These broadscale circulations determine the regional patterns of rapidly changing fire weather-long term trends resulting in periods of wetness or drought and above or below-normal temperatures, and in seasonal changes in fire weather. If we are to become acquainted with these variations in fire weather, we must understand how they are brought about, and the settings in which they take place.

The response to overall airflow applies also to local fuel conditions, so an understanding of general air circulation within the troposphere is essential to a usable knowledge of wildland fire behavior.

GENERAL CIRCULATION

So far we have been concerned principally with the static properties of the atmosphere-its temperature, moisture, and pressure. In this chapter we will begin a more detailed consideration of the dynamics of the atmosphere-its motion-which was introduced in chapter 1.

We learned in chapter 1 that the atmosphere is a gaseous mantle encasing the earth held there by gravity-and rotating with the earth. Within this huge envelope of air there are motions of a variable nature. If forces were not present to act on the atmosphere and upset its equilibrium, there would be no atmospheric motion-no circulation. The pressure exerted by the weight of the atmosphere would be the same everywhere at a given level. But disturbing forces are present. The earth is not

heated uniformly, and the resultant unequal heating of the atmosphere causes compensating air motions, which tend to reduce the horizontal temperature differences.

The actual motions that are developed within the atmosphere are extremely complex and are not yet fully understood. Theories and models, which have been derived, are not wholly accepted because they do not completely account for all of the observed atmospheric motions. Most of the major features of the global circulations are rather well understood. Therefore, future modifications of present-day theories resulting from further research will not seriously affect our understanding of the general circulation as it relates to fire weather.

PRIMARY CIRCULATION

In equatorial regions the earth's surface receives more solar energy from the sun than it radiates back to space, and therefore acts as a heat source for the air in these regions. In polar regions the earth's surface radiates more energy into space than it receives from the sun. Since equatorial regions do not get hotter and hotter, and since polar regions do not become progressively colder, **there must be some net transport of heat energy from equatorial to polar regions.** Just how this is accomplished is one of the major features of the general circulation that is not completely understood. This transport could be accomplished by closed horizontal "cells" with north-south flow, by large-scale eddies, or, perhaps, by both methods. We will consider both methods.

Convective Circulation

Let us suppose that the earth's surface was uniform, that the earth did not rotate, and that it was uniformly heated around the entire Equator.

Certainly this is a very hypothetical situation, but let us accept it for the sake of development of our discussion. We know that regions of warm surfaces, which warm the air overlying them, are characterized by rising air. The warming air expands and is forced aloft by the cooler, denser air flowing in from adjacent areas.

In equatorial regions the warm air would rise to near the tropopause, reach a level of the same air density, then spread out and flow both north and south. As it moved toward the poles, it would cool by radiation and sink as its density increased. In the polar regions it would descend and begin to move toward the Equator.

In this hypothetical case the transport of heat could take place by simple convective circulation. At the earth's surface there would be a permanent low-pressure belt around the earth at the Equator and a high-pressure area at each pole.

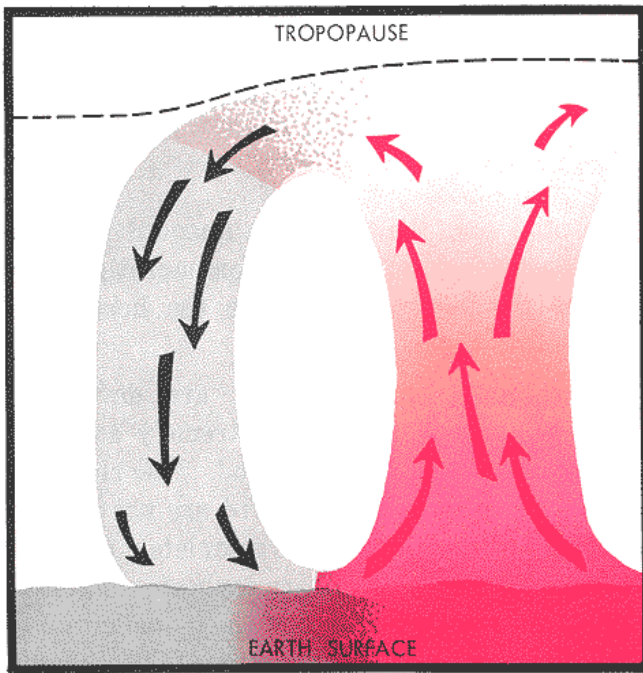

In a simple convective circulation, warm air expands and is forced aloft. As it cools, it descends and returns to the heat source.

Since the earth does rotate, and since the sun is its single source of energy, this simple convective pattern cannot exist. The real circulation patterns are the result of the unequal

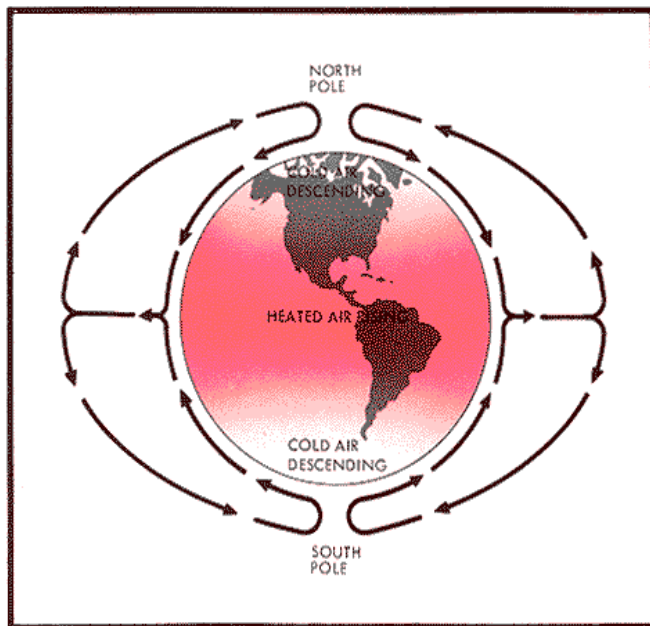

If the general circulation could be represented by a simple convective circulation, heated air at the Equator would rise to near the tropopause, then spread out both north and south. Toward the poles, it would cool, and finally descend and move back to the Equator.

heating mentioned above combined with the effect of the earth's rotation and the unequal partitioning of heat due to the uneven distribution of land and sea areas. Before we discuss the circulation on a rotating earth with a uniform surface, we will need to consider why and how the earth's rotation affects airflow.

How the Earth's Rotation Affects Airflow: Coriolis Force

If a map of air, or any other body, moves in a straight line as viewed from a position in space, its path as viewed from a position on the earth is curved. The curvature indicates a deflection to the right in the Northern Hemisphere and a deflection to the left in the Southern Hemisphere. The reason for the deflection is that the earth, rotating toward the east on its axis, turns underneath the moving air or body. This deflective force is called the Coriolis force. It is an apparent rather than a real force, but since we are stationed on earth and view motions from the earth, the deflection is real from all earthbound positions.

To visualize the Coriolis force, let us consider a large disk or merry-go-round, rotating in a counterclockwise direction, as representing the Northern Hemisphere. A boy tossing a ball from the center outward would find that the ball made a straight path in space, but traced a curved path on the disk below showing a deflection toward the right. Although more difficult to visualize, it is a fact that if the boy were stationed at any place on the rotating disk and tossed the ball in any horizontal direction, the ball would trace a curved path on the disk with a deflection to the right.

On the rotating earth, an air current in the Northern Hemisphere starting as a southerly wind, that is, moving toward the north, would be deflected to the right and become a southwest or west wind. Likewise, a north wind deflected to the right becomes a northeast or east wind. Since the northward airflow aloft just north of the equatorial region becomes nearly a true westerly flow, the northward movement is slowed and the air "piles up" at about latitude 30°N. The air also loses considerable heat by radiation.

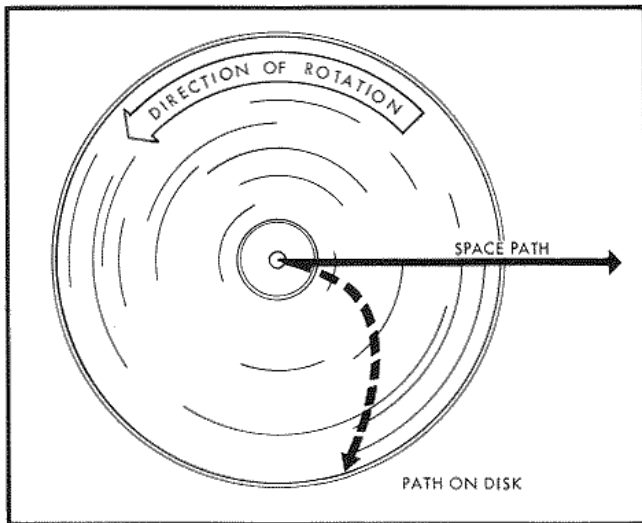

A ball tossed horizontally from the center (or, in fact any location) on a large, counterclockwise rotating disk will take a straight path in space, but, because of the Coriolis force, the path traced on the disk will show a deflection to the right.

Because of the piling up and the heat loss, some of the air descends, producing a surface high-pressure belt, while the rest continues in the westerly current aloft. Air that has descended flows both northward toward the pole and southward toward the Equator at the surface. Again, the effect

of the earth's rotation comes into play. The northward-flowing current is turned to the right and becomes the prevailing westerlies of middle latitudes. The southward-flowing current, also deflected to the right, becomes the **northeast trades of the low latitudes**.

The air aloft that gradually moves northward continue to lose heat. In the polar regions it descends, gives up additional heat to the surface, and flows southward. This current is also turned to the right by the Coriolis force and becomes the polar easterlies of high latitudes. The cold air gradually pushes southward and finally meets the northward-flowing tropical air in what is referred to as the polar front zone. The polar and tropical air masses, which have different densities, tend to resist mixing. Instead, the lighter tropical air flows up and over the forward edge of the denser polar air.

This type of cellular circulation causes air to accumulate in the polar region. When the

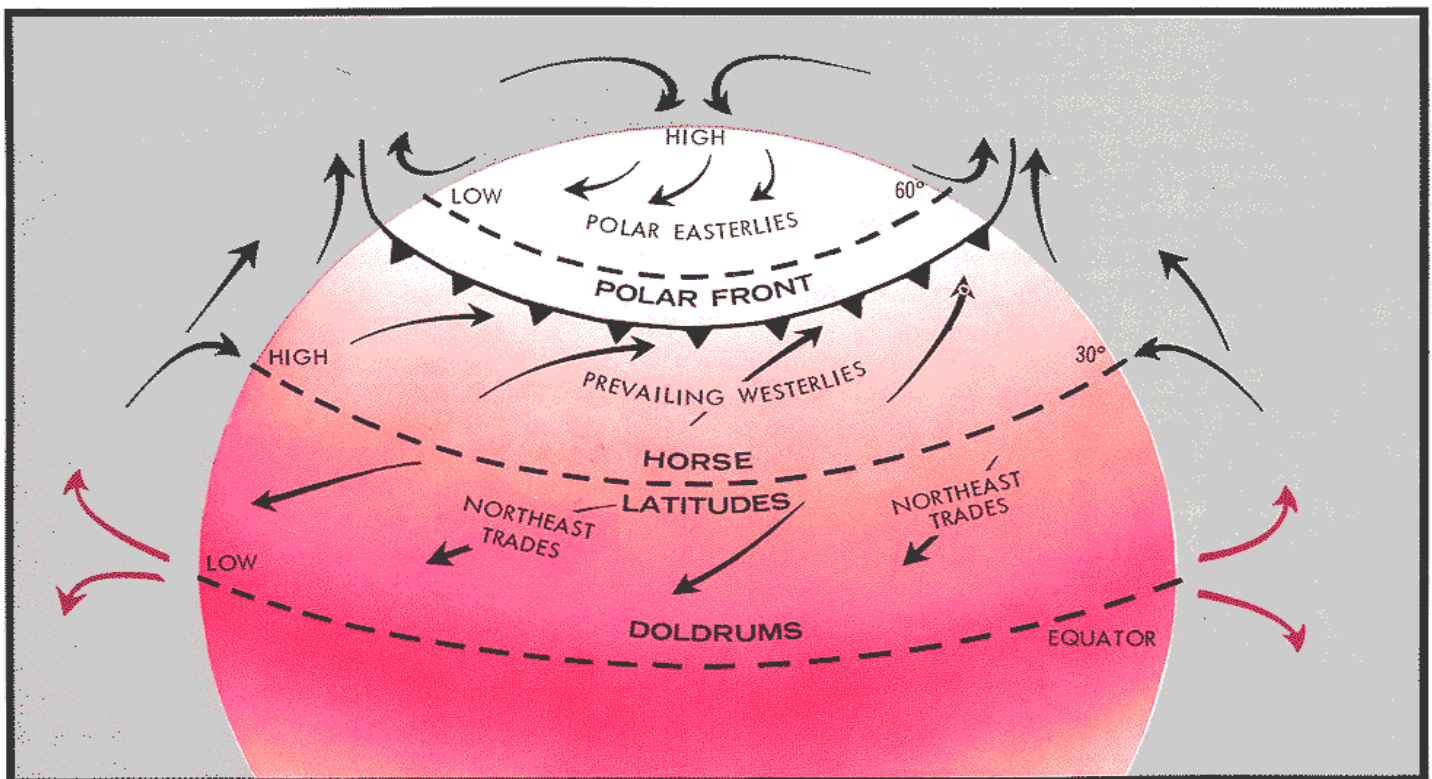

On a rotating earth with a uniform surface, the general circulation of the Northern Hemisphere would be composed of the trade winds, prevailing westerlies, and polar easterlies.

mass becomes great enough, the polar front zone is pushed southward, and the cold polar air penetrates to fairly low latitudes in a "polar outbreak". In this simplified circulation system, heat energy is carried northward by the airflow aloft, and cold air moves southward in cold outbreaks to maintain a balance of energy between equatorial and polar regions.

This primary circulation system results in the formation of several well-defined major regional circulation patterns or **wind belts**, some of which we have already mentioned. These are known as: Doldrums, trade winds, horse latitudes, prevailing westerlies, polar front zone, and polar easterlies.

The equatorial region of warm and moist rising air currents is referred to as the **doldrums**. It is a region of light surface winds, considerable cloudiness, and widespread shower activity. When the doldrum belt moves north from the Equator, as it does in the summer and early fall, it becomes the "breeding ground" for tropical storms and hurricanes.

Near latitude 30°N. is a region of descending air and high pressures known as the horse latitudes. As we will see later, the high atmospheric pressure in this region is usually best developed over the oceans. The high-pressure areas are characterized by light variable winds, little cloudiness, and little rainfall. Between the doldrums and the horse latitudes is the belt of trade winds-northeast trades in the Northern Hemisphere and southeast trades in the Southern Hemisphere.

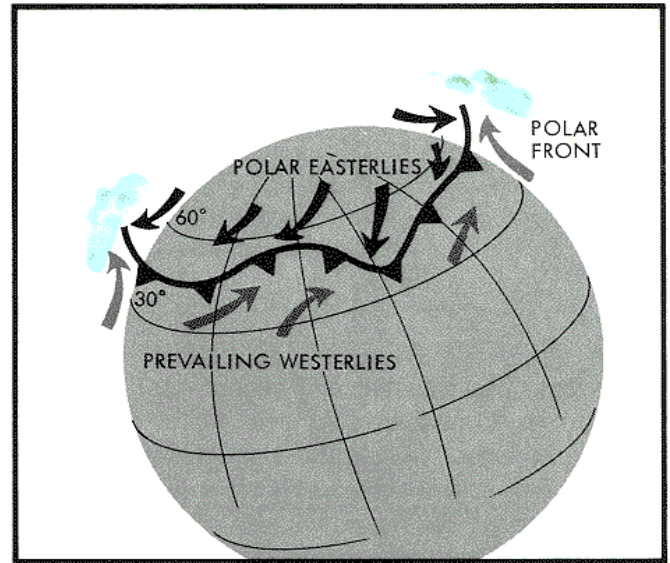

The polar front zone is an area of storminess, cloudiness, and precipitation, and its position is extremely variable.

The belt of westerlies extends from about 30°N. to about 55°N. North of here are the polar easterlies mentioned earlier. The **polar front zone**, between the prevailing westerlies and polar easterlies, is a zone of storminess, cloudiness, and precipitation. Its position around the hemisphere is extremely variable. Sometimes it plunges far southward into middle latitudes with cold air outbreaks; at other times it is carried far northward with intrusions of tropical air to high latitudes. We will see later that it is tied to the circulation aloft, particularly to the meandering stream of westerly winds in the upper troposphere.

PRESSURE PATTERNS

The simple primary circulation described above should result in a band of low pressure around the earth in the equatorial region, a band of high pressure about latitude 30°N., a band of low pressure in the polar front zone, and an area of high pressure in the polar region. However, if we study the distribution of pressure over the Northern Hemisphere we do not find the bands to be entirely uniform. Instead we find **pressure cells**-areas with higher or lower pressure than the surrounding region. Some of these are semi permanent cells, which remain relatively fixed; others are migratory.

The weather is closely related to these pressure cells and other pressure patterns. If we are to understand and predict the weather, we need to determine the **distribution of atmospheric pressure**.

Atmospheric pressure was introduced to us in chapter 1. We learned that the atmosphere has mass and that atmospheric pressure is the result of the force of gravity acting on this mass. Atmospheric pressure can be measured by balancing the weight of the atmosphere against that of a column of mercury. This is done with a mercurial barometer. Another type

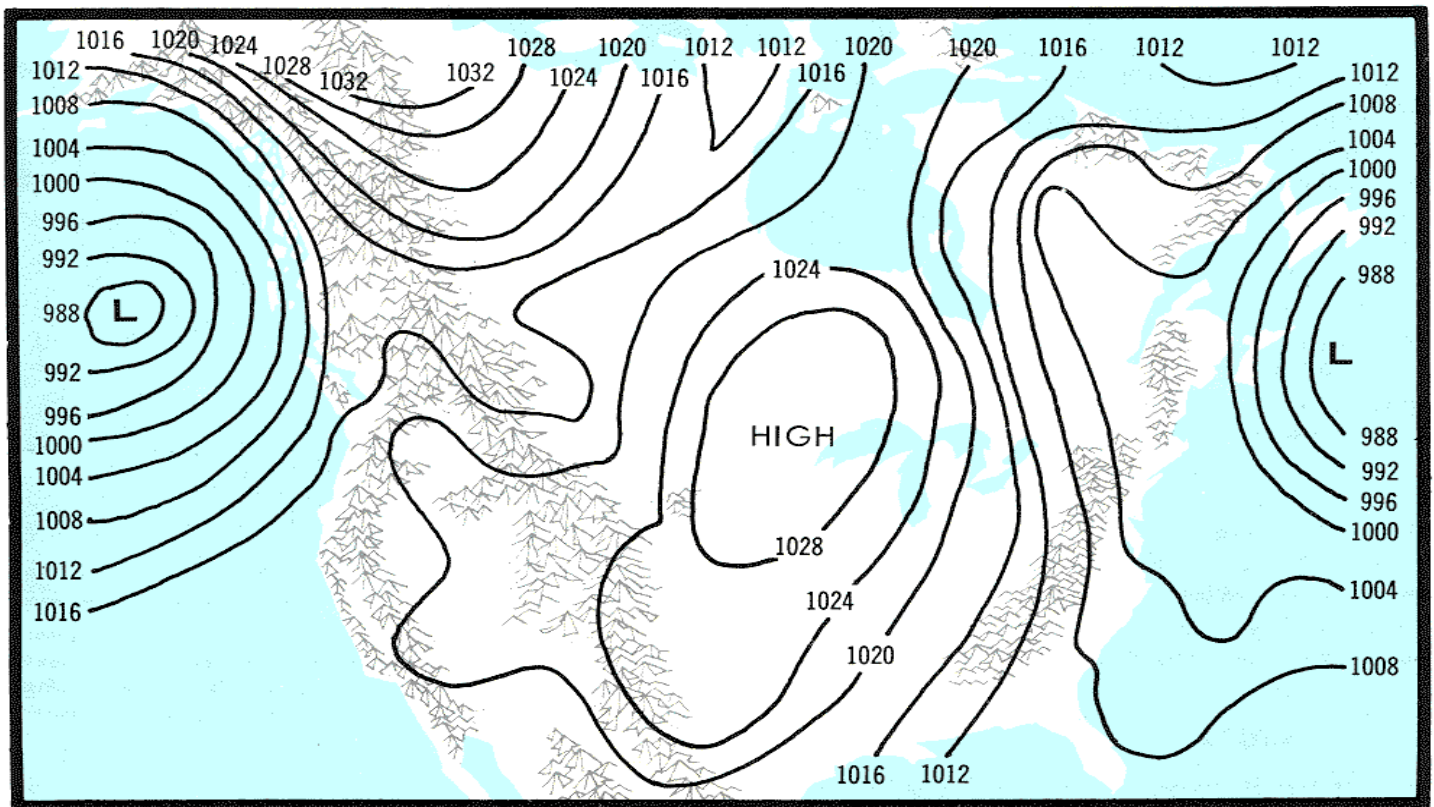

A surface weather map is a graphical picture of the pressure distribution obtained by drawing lines, called isobars, through points of equal sea-level pressure. Isobars outline areas of high and low pressure.

of barometer, called an aneroid, has a partially vacuated metallic cell, so constructed that the sides tend to collapse under increasing atmospheric pressure and to expand with decreasing pressure. This movement is magnified by levers and is transmitted to a hand or pen, which indicates the pressure reading on a scale. We also learned in chapter I that atmospheric pressure at any location varies with time and decreases with altitude.

Constant-Level, Constant-Pressure Charts

To study the pressure distribution, we need, first of all, pressure measurements taken simultaneously at a number of stations. Meteorologists refer to these as synoptic observations. Secondly, since stations are at different elevations and we wish to compare one pressure measurement with another, we need to correct the pressures to a common level, usually sea level. This is done by adding to the station pressure the weight of a hypothetical column

of air extending from the level of the station down to sea level. Corrected readings are collected at a central point and plotted on a weather map. **Such weather maps are called synoptic charts.**

A graphical picture of the pressure distribution is obtained by drawing lines, called isobars, through points of equal pressure. Isobars are labeled in millibars (mb.) and are drawn usually for intervals of 4 mb., although the interval may vary with the map scale. Isobars may be thought of as contours of pressure, somewhat similar to contours of elevations on a topographic map.

Pressure patterns aloft are also important in determining the structure of the atmosphere. They are portrayed in a slightly different way, however. Instead of determining pressure variations at a constant level, such as is done on the sea-level chart just described, the variations in the height of a **constant-pressure** surface are charted. The pressure surfaces used in the

troposphere are 850 hPa. (about 5,000 feet), 700 mb. (about 10,000 feet), 500 mb. (about 18,000 feet), and 300 mb. (about 30,000 feet).

The heights above sea level, usually in tens of meters, of the pressure surface at a number of stations are plotted on a weather map. Contours of height for 60-meter intervals are drawn through points of equal height. These contours are strictly analogous to the contours on a topographic map. The only difference is that the constant pressure chart depicts the height of a pressure surface, while the topographic map depicts the height of the ground surface above sea level.

For our purpose, it makes little difference whether we think of pressure distribution in terms of a constant-level or constant-pressure chart. Areas of high pressure on a constant level chart would appear as areas of high heights on a constant-pressure chart, and low-pressure areas would show up as low heights.

Lows, Troughs

When a weather map is analyzed as described above, we find certain configurations, or

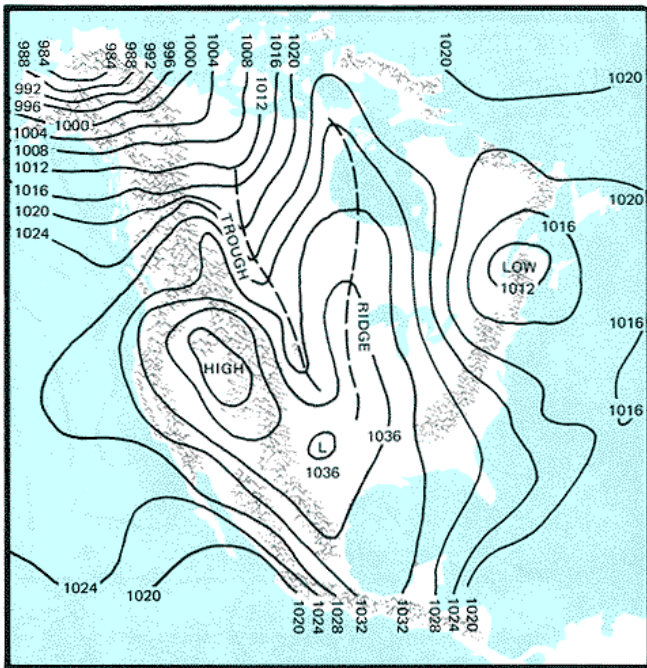

Air around a low flows counterclockwise in the northern Hemisphere and spirals inward. This converging airflow produces rising motion, and, if sufficient moisture is present, precipitation will result.

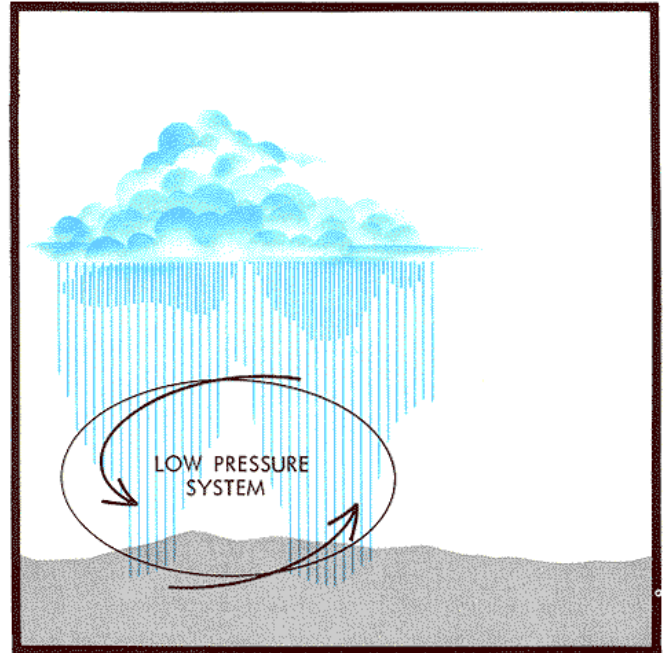

A line of low pressure is referred to as a trough, and a line of high pressure is referred to as a ridge. The curvature of the isobars in a trough is cyclonic; in a ridge, anticyclonic.

patterns. On a sea-level chart we will find areas that have a lower pressure than the surrounding region. These are called **low-pressure centers** or areas, or simply **Lows** for short. They are also called **cyclones** because the air flows around them in a cyclonic direction (counterclockwise in the Northern Hemisphere). Lows are usually characterized by inward and rising air motion, which results in cooling and increased relative humidity. Sufficient lifting with adequate moisture will produce condensation of water vapor into clouds and may result in precipitation. Latent energy released by the condensation adds to the energy of the circulation system.

A line of low pressure is referred to as a **trough**. The pressure along the line is lower than the pressure on either side. The isobars show a cyclonic curvature at the trough line but do not form a closed circulation. The characteristics of a trough are similar to those of a Low. Frequently a trough delineates the boundary between two different airflows and is a common place for the development of storm centers.

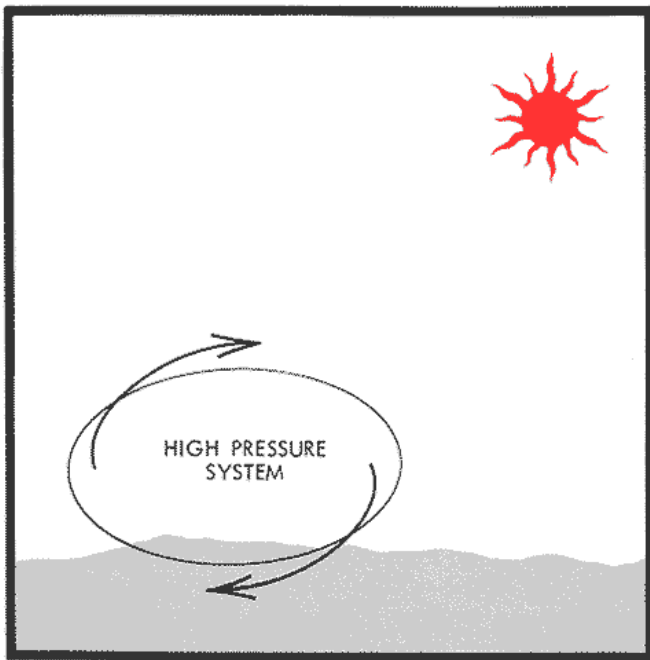

Circulation around a High is clockwise in the Northern Hemisphere and spirals outward. This divergent flow is accompanied by downward motion, with the result that cloudiness and precipitation are minimum/

Highs, Ridges

High-pressure cells are another type of pressure pattern observed on analyzed weather maps. A **high-pressure area** is surrounded on all sides by lower pressure. We call it a **High** for short. It may also be referred to as an anticyclone because the windflow around a High is anticyclonic (clockwise in the Northern Hemisphere). The airflow in a High is generally outward and descending. For this reason, Highs are usually areas of minimum cloudiness and little or no precipitation. If the air descends from very high altitudes, it may be extremely dry.

Ridges are lines of high pressure. The pressure is higher along the ridge than on either side. The curvature of isobars at a ridgeline is anticyclonic, but the isobars do not form a closed circulation. Ridges exhibit characteristics similar to Highs, with descending air and a minimum of cloudiness and precipitation.

PRESSURE AND WIND RELATIONS

Air always moves in response to pressure differences. As it moves, its speed and direction of motion are governed by a combination of forces. These include the pressure-gradient force, which causes air to move from high to low pressure; the **Coriolis force**, which causes a deflection to the right in the Northern Hemisphere; an outwardly directed centrifugal force if air is flowing in a curved path; and friction, which opposes all air movement near the surface of the earth.

Airflow can take place along a straight or curved path. Let us consider first the simpler case, that is, straight flow at a level high enough in the atmosphere so that friction with the earth's surface is negligible. For this case, only two of the forces mentioned above need be considered the pressure-gradient force and the Coriolis force.

Pressure gradient may be defined as the change of pressure per unit distance, for example, millibars per 100 miles. On the sea level map, as mentioned above, isobars are drawn for specific intervals of pressure. The

closer the isobar spacing, the stronger the pressure gradient, and vice versa. The pressure gradient force tends to make air flow across the isobars from high to low pressure. But, as the air moves, it is deflected to the right by the Coriolis force. This force acts in a direction perpendicular to the airflow, and its magnitude depends upon both the speed of the airflow and upon the latitude. The reason for this is that the Coriolis force is caused by the rotation of the earth's surface beneath the airflow, and the rotation of the surface around a vertical axis depends upon the latitude. This rotation, and therefore the latitudinal effect of the Coriolis force, is greatest at the poles and decreases to zero at the Equator.

Geostrophic, Flow

Balance between the pressure-gradient force and the Coriolis force is achieved when these two forces oppose each other with equal magnitudes. The resulting flow is then parallel to the isobars, rather than across the isobars. If these forces are diagrammed, the pressure-gradient

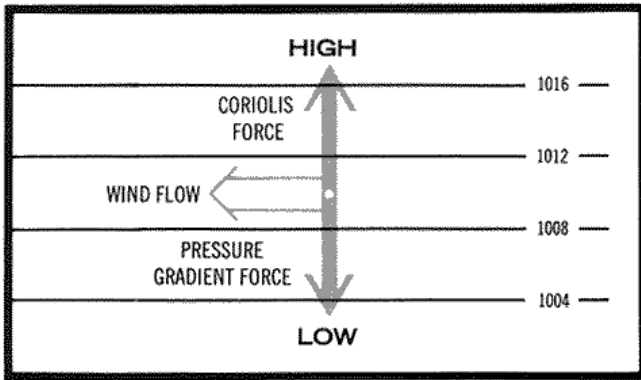

Geostrophic flow occurs in regions of straight-line isobars. The pressure-gradient force from high to low pressure balances the Coriolis force, which is at right angles to the flow. The flow is parallel to the isobars, with high pressure on the right.

force is drawn at right angles to the isobars in the direction of low pressure. The Coriolis force is drawn at right angles to the line of motion and is directed toward the right in the Northern Hemisphere.

At a given latitude the speed of the airflow, increases with an increased pressure gradient - a decrease in the distance between isobars. With equal pressure gradients, a greater air speed will occur at lower latitudes than at higher latitudes because of the influence of latitude on the Coriolis force.

Straight flow, which occurs in regions of straight-line isobars, is termed geostrophic flow and implies balance between the pressure gradient and Coriolis forces.

Gradient Flow: Highs and Lows

In most areas on a weather map the isobars are curved rather than straight. The result is

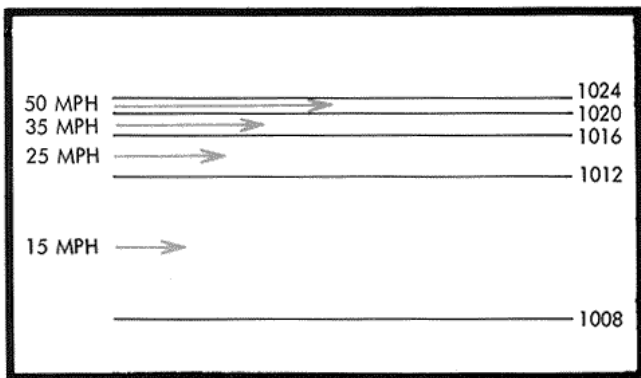

At a given latitude, the speed of the airflow increases with increased pressure gradient; that is, with a decrease in the distance between isobars.

that as air moves, the direction of the pressure gradient force changes, and so does the airflow, to follow the curving isobars. Here, an additional force must be considered-the outwardly directed centrifugal force. For steady motion, a balance must exist between the pressure-gradient force, the Coriolis force, and the centrifugal force. When these forces are in balance, the airflow is still parallel to the isobars, but it is known as gradient flow. As with geostrophic flow, high pressure is on the right in the Northern Hemisphere, as one looks downstream. Therefore, the direction of flow is always clockwise around a high-pressure center and counterclockwise around a Low.

The balance of forces for gradient flow is more complicated than for geostrophic flow. If the forces around a Low were diagrammed, the pressure-gradient force is drawn at right angles to the isobars and directed inward. The Coriolis force is at right angles to the airflow and directed toward the right, which is outward, and the centrifugal force is at right angles to the isobars and directed outward. When the

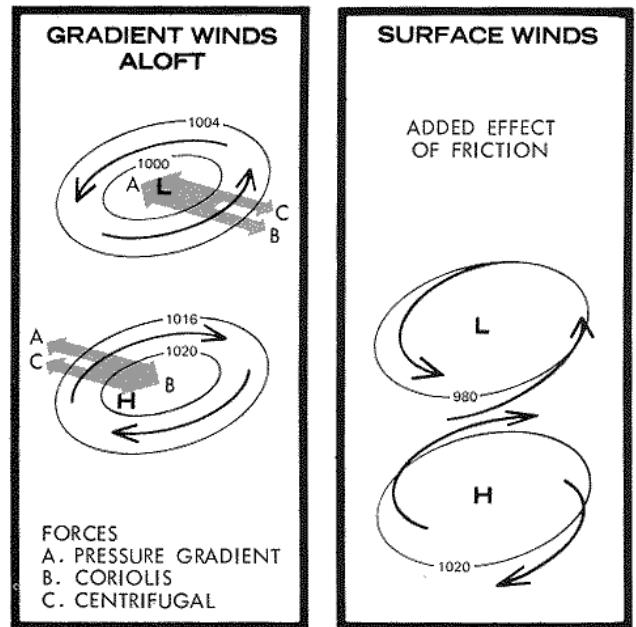

Left. - In a low the pressure-gradient force tends to balance the Coriolis and centrifugal forces, and the resultant flow is cyclonic (counterclockwise in the Northern Hemisphere). In a High the Coriolis force tends to balance the pressure-gradient and centrifugal forces, and the resultant flow is anticyclonic. Right. - Friction with the earth's surface causes air to flow spirally outward across the isobars from a High and spirally inward around a Low.

three forces are in balance; the pressure-gradient force balances the sum of the Coriolis and centrifugal forces.

If the forces around a High are diagrammed, the centrifugal force is, of course, still directed outward. But now the pressure gradient force is directed outward, and the Coriolis force is directed inward. This means that the sum of the pressure-gradient and centrifugal forces balances the Coriolis force.

In both low- and high-pressure systems, the speed of the wind increases with increased pressure gradient; that is, with closer spacing of the isobars. Because the centrifugal force is added to the pressure-gradient force in a High, and subtracted from it in a Low, the wind speed in a High will be greater than in a Low with the same pressure gradient. In spite of this, we find higher wind speeds in Lows because the pressure gradients are usually much stronger.

One other characteristic difference also exists. In a low-pressure system, increased pressure gradients and increased air speeds may occur as the center is approached. We can have, and of ten do observe, very strong wind speeds near the center of Lows. In a High,

however, because of the balance of forces there is a limiting value of wind speed that cannot be exceeded as the center is approached. We find, therefore, that Highs have low wind speeds and weak pressure gradients near their centers.

Friction

So far we have considered straight flow and curved flow at levels high enough in the atmosphere so that the force of friction could be disregarded. But when we consider airflow near the ground, we must account for the friction force. The effect of friction on airflow is to retard the movement. Therefore, friction is a force acting in a direction opposite to the airflow. Since the Coriolis force varies with the wind speed, a reduction in the wind speed because of friction produces a reduction in the Coriolis force.

For steady motion there must be a balance among the pressure-gradient, centrifugal, Coriolis, and friction forces. The resulting balanced motion is a flow directed slightly across the isobars from high to low pressure. The amount of deviation depends upon the roughness of the terrain and will vary from 10 to 15 degrees over water to 25 to 45 degrees over

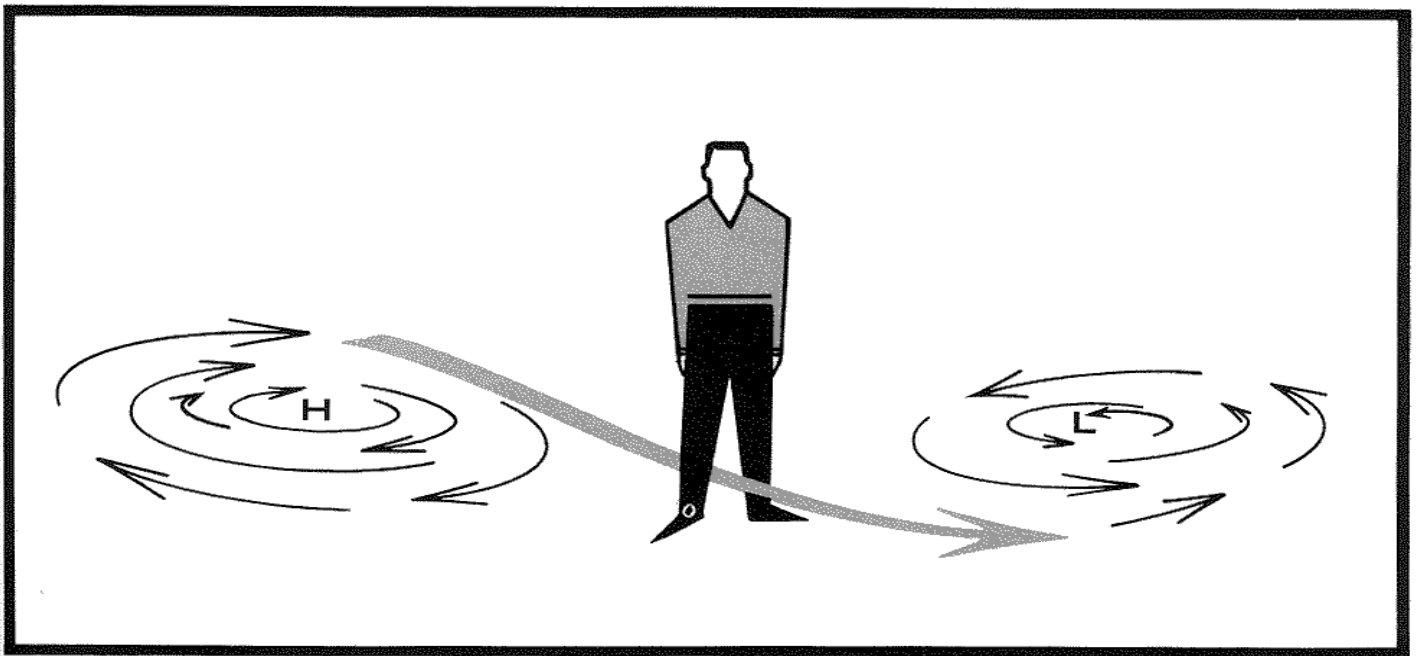

“Back to the wind, high pressure on the right” is a useful rule. Because of friction, air near the surface flows from high- to low-pressure areas. Air accumulated near the surface in low centers is forced aloft; the removal of air from High centers requires downward displacement of air.

land. The speed of the airflow is always lower with friction than without friction.

Friction assists in the transfer of air from high- to low-pressure areas. Because of friction, air flows spirally outward from a High and spirally inward around a Low near the surface. A person standing with his back to the wind has high pressure to his right and a little to the rear, and low-pressure on his left and a little forward. The effect of friction is, of course, greatest near the surface and decreases upward in the atmosphere. The depth of its influence varies directly with surface roughness and with atmospheric instability.

CIRCULATION PATTERNS AT UPPER LEVELS

Our discussion of Highs, Lows, troughs, ridges, and the relationship between pressure and wind has been concerned primarily with the surface map, which is a constant-level map. The same terms and the same relationships apply to constant pressure charts used to portray the upper-air circulations described earlier. The balance of forces for airflow on a constant-pressure chart is similar to that on a constant-level chart. The only difference is that the pressure-gradient force is represented by the gradient of height of the constant-pressure surface. The friction force is disregarded on upper-air charts.

The circulation patterns in the middle and upper troposphere are quite different from those near the surface. They are less complicated because the effects of local heating of land and water, and of topography on air movements are greatly reduced. The major or large-scale hemispheric circulations are more in evidence. Troughs and ridges are common, but completely closed circulations-Highs and Lows-tend to decrease in frequency with altitude.

Circumpolar Westerlies

Except for a deep layer of easterly flow in equatorial regions, which reaches to the upper troposphere, the airflow aloft in the Northern Hemisphere consists of a broad belt of **westerly winds** extending from the subtropics to the polar regions. This belt of westerlies forms a large **circumpolar vortex**. An upper-air chart of the

Generally, at altitudes higher than 2,000 feet above the surface, the effect of friction can be disregarded. Above this altitude, the airflow tends to be more nearly parallel to the isobars.

The development of new pressure systems, and the intensification or decay of existing systems, as well as the migrations of these systems, cause many deviations in observed wind speeds and directions. Additional deviations develop because of local terrain. The combined effects of these influences can be seen by comparing the observed surface winds with the sea-level isobars on a surface weather map.

Northern Hemisphere will show that this is not a smooth circular vortex; instead, it is a meandering current forming waves of varying amplitude and wavelength. These horizontal waves appear as part of the pattern of an upper-air chart.

Meteorologists classify the waves into two categories: **Long waves** which usually number three to seven around the hemisphere, and short waves which are superimposed on the pattern of long waves. The long waves move slowly. They may drift eastward slowly; remain stationary for a number of days, and even retrograde on occasion. The westerly current in a long-wave **ridge** may go far to the north and allow tropical air to be carried to high latitudes. In a long-wave **trough**, the westerlies may go far to the south and allow cold polar air to reach low latitudes.

A persistent long-wave pattern plays an important role in prolonged periods of abnormal weather. The region beneath a long-wave ridge is likely to experience clear, dry weather with above-normal temperatures. The region beneath a long-wave trough is likely to have cloudy, wet weather with below-normal temperatures.

Two types of long-wave patterns in the belt of westerlies are distinguished. One is a large-amplitude, short-wavelength pattern, called **meridional**. It is effective in carrying tropical air to high latitudes and polar air to low latitudes. The other is a small-amplitude, long-wavelength pattern, called **zonal**, in which

the principal movement of Highs and Lows in mid-latitudes is west to east.

Short waves are smaller, rapidly moving oscillations, which proceed through the long wave pattern. They move northward around long-wave ridges and southward through long wave troughs. The speed of the short waves is usually slower than the wind speed aloft, indicating that the air moves through the waves. The short waves are associated with migratory Lows and Highs at the surface, and their movement is about the same speed as the surface systems.

Long waves cannot be shown by lines because the exact positions are usually obscured by short waves. Generally, what one sees are

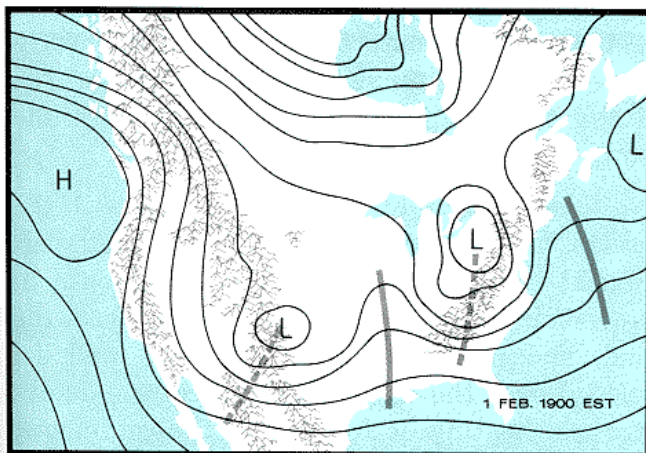
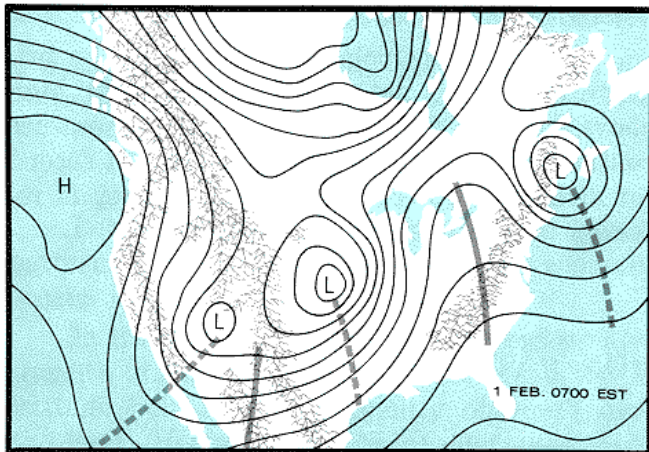

These two 500 mb. charts, 12 hours apart, illustrate short wave moving through the long-wave pattern. Short waves are indistinct in the long-wave ridge position in the Gulf of Alaska. Short-wave troughs, shown by dashed lines, tend to deepen in the long-wave trough position, which extends into Northern Mexico. Short-wave ridges, shown by solid lines, are indistinct in the long-wave trough, but develop as they move out of the trough, as did the one, which moved, from the southwest and Northern Mexico into the Mississippi Valley.

the short-wave troughs and ridges. The long-wave trough positions are usually identified by the place where short-wave troughs deepen. The same applies to long-wave ridge positions and short-wave ridges.

The migration of large-scale eddies - the Highs and Lows - is **the second method of transporting** excess heat away from lower latitudes (mentioned at the beginning of this chapter). The cyclonically rotating Lows in their travel from lower to higher latitudes on the east side of long-wave troughs are effective in pulling warm tropical air far north ahead of them and cold polar air far south behind them. The Lows eventually dissipate at high latitudes. Cold polar Highs moving south, usually on the west side of long-wave troughs, eventually merge with semi-permanent Highs in the horse latitudes. Thus, these large cyclonic and anticyclonic eddies are mechanisms by which warm air is transported northward and cold air is transported southward across the middle-latitude belt of westerlies.

Closed circulations are sometimes found within the troughs and ridges aloft. Contours may indicate a closed High in a large-amplitude, long-wave ridge. Closed Lows may be found in long-wave troughs, and occasionally in short-wave troughs.

Jet Stream

Within the belt of westerlies there is often a core of very strong winds, called a jet stream. This fast-flowing river of air near the tropopause has wind speeds of 50 to 150 or 200 m.p.h. It is usually 100 to 400 miles wide and 3,000 to 7,000 feet deep. When more than one jet stream occurs, the principal one is the polar-front jet stream associated with the surface polar front. It meanders in a wavelike pattern as part of the general westerly flow. Like the polar front, it is stronger in some places than others. It rarely encircles the entire hemisphere as a continuous river of air. More frequently, it is found in segments 1,000 to 3,000 miles long.

The north-south temperature gradient in the upper troposphere is concentrated in the jet-stream region. In fact, the jet stream is found only in those areas where a marked temperature gradient has developed. Below the

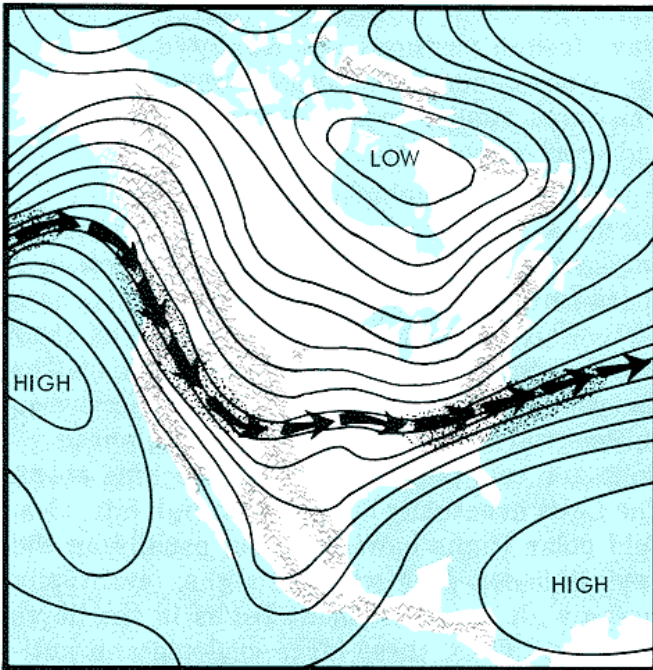

The jet stream, as shown on a constant-pressure chart in the upper troposphere, is meandering, fast-flowing river of air embedded in the belt of westerlies. The stippling shows the regions of strongest winds that move along the jet stream.

jet, the region to the right is warm as one faces downstream, and the region to the left is cold. Above the jet stream, the warm and cold regions are reversed.

The mean position of the jet stream, and the belt of westerlies in which it is embedded, shifts south in the winter and north in the summer with the seasonal migration of the polar front. As it moves southward in the winter it also moves to higher altitudes and, on the average, its speed increases. The seasonal position of the jet stream is related to seasonal weather. During some summers its mean position may not be as far north as usual, and this position reflects summers that are cooler than normal. Similarly, during winters that are milder than normal, the jet stream does not move as far south as usual.

Although the polar jet stream is the primary one, other jet streams may exist high above surface fronts where the temperature contrast between air masses is sharp. A second jet stream south of the polar front jet is referred to as the subtropical jet.

TYPICAL CIRCULATION PATTERNS

The circulations that we observe are the combined results of the primary and secondary circulations, which, in turn, are produced by the uneven heating of the earth because of differences in latitude and in the distribution of land and water masses.

Semi-permanent Centers

As mentioned earlier, the nonuniform character of the earth's surface results in cells of high pressure in the horse latitudes and cells of low pressure in the polar front zone, rather than continuous belts. Some high- and low-pressure systems appear so consistently in certain areas that they are considered semi-permanent and are given names.

Those of interest to us are the **Pacific High** in the Pacific, the **Azores-Bermuda High** in the Atlantic, the **Aleutian Low** in the Northern Pacific, and the **Icelandic Low** in the Northern Atlantic. These may be displaced from their normal positions occasionally, and at times portions;

will break off and become migratory, especially the Lows. Usually though, these semi-permanent centers will remain stationary and quite strong for several days or weeks. The Highs tend to be more persistent than the Lows.

The strength of these cells varies with the season, and the development of other, less permanent cells is also a function of seasons. In the summer, the oceans are colder than the land, and high-pressure centers are well developed over the oceans. Low pressure, due to stronger heating, is found over the continents. Over Southern Asia a semi-permanent Low develops in summer and a similar Low on a smaller scale is found in our Southwest. During the winter, the continents are colder than the oceans. A seasonal High develops in Siberia, and high pressure is common over North America. The semi-permanent Lows over the warmer oceans are well developed.

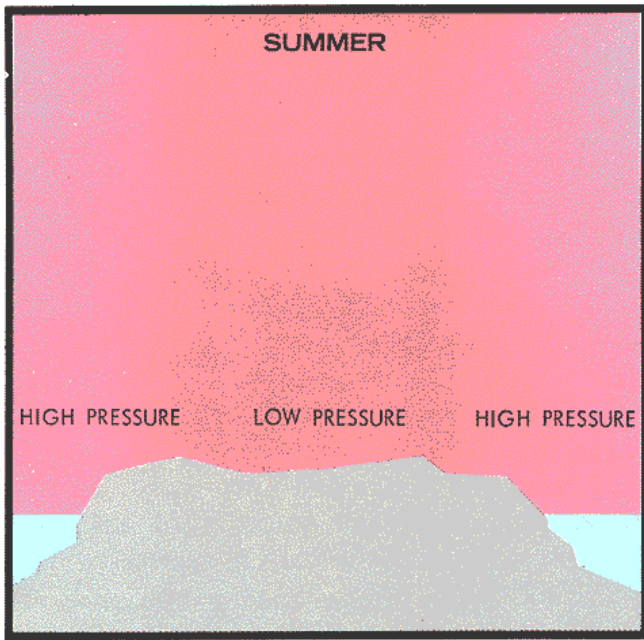

In summer the continents are warmer than the oceans, and there is a tendency for lower pressure over the continents and relatively higher pressure over the adjacent oceans.

Let us consider the summer and winter patterns over North America and the adjacent means in more detail.

In the summer, because of the comparative warmth of the land, high pressure in the horse latitude belt is not frequently observed over the land. However, the Azores-Bermuda High

often extends into the Southeastern States. The Pacific High and the Azores-Bermuda High are strong and rather far north as compared to their winter positions. The Icelandic Low is weak. The Aleutian Low is not present in the Aleutian area, but low pressure is found over Northeastern Siberia. The intense summer heat over the dry Southwest forms a low-pressure area known as the **California Heat Low**. Temperature contrasts between equatorial and polar regions are smaller in summer than in winter. Pressure gradients are weak, and the resulting air motion is slow compared to winter.

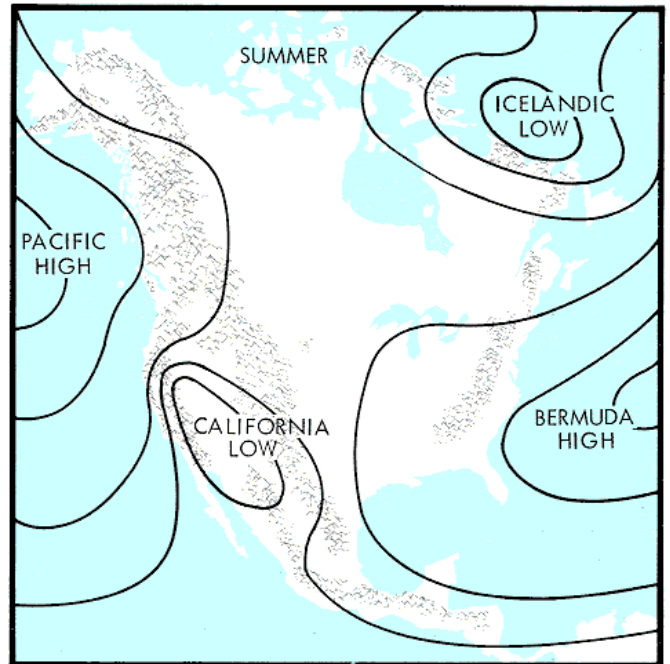

The average July sea-level pressure pattern, representing the summer months, shows the Pacific and Bermuda Highs as being strong and rather far north. The Icelandic Low is weak, pressure is generally low over the continent, and the intense heat in the Southwest forms the California Heat Low.

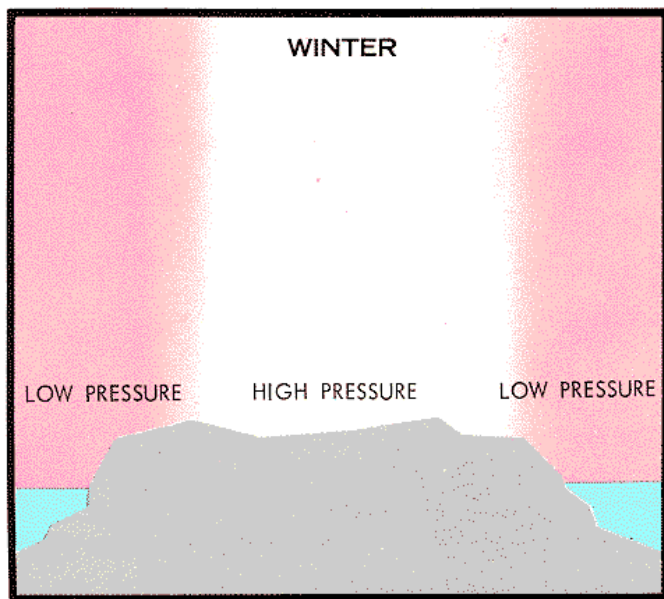

In the winter the continents are colder than the oceans, and there is tendency for the denser, stagnating air to form high-pressure cells over the continents while lower pressure exists over the oceans.

Aloft, the circumpolar vortex is small. This means that the belt of westerlies, the jet stream, and the polar front are far north. The westerlies are weak and confined to a relatively narrow band. The tracks of most surface Lows are also rather far north; these Lows usually travel eastward through Southern Canada or the Northern States. A few travel northeastward through the Southern and Eastern States or along the Atlantic coast. The tracks of polar Highs are similarly far north.

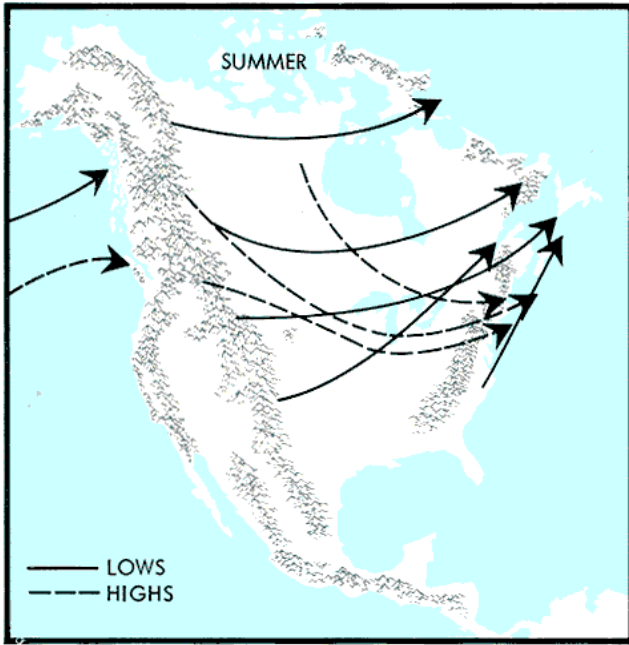

In the summer the preferred tracks of migratory Lows and Highs are rather far north, mostly across Southern Canada or the Northern States. A few Lows travel northeastward along the Atlantic coast.

The strong Azores-Bermuda High and Pacific High have a pronounced influence on summer weather in certain regions. The circulation around the western end of the Azores - Bermuda High (Bermuda High for short) brings warm, moist tropical air from the Atlantic and Gulf of Mexico into most of the Eastern and Central United States. When this High extends far westward across the Gulf States, moisture from the Gulf is effectively cut off, and the East has hot, dry weather.

Along the Pacific coast, the Pacific High blocks most Lows and forces them far to the north. The eastern end of the Pacific High is a region of subsiding air aloft. This subsiding air, which overlays a shallow layer of cool, moist air carried to the coast by northwest winds, produces a very stable condition and results in dry summer weather along the coast.

During winter, the Aleutian and Icelandic Lows are well developed. The Aleutian Low extends from the Aleutian Islands into the Gulf of Alaska, and much stormy weather and precipitation in the Western States are associated with the movement of this low-pressure system or segments of the main cell which break off and move south and southeast. The strong circulation

around the Icelandic Low produces northerly winds and frigid weather in the eastern section of the continent. The Pacific and Bermuda Highs are weaker and displaced farther south in winter than in summer. Temperature contrasts between the tropics and polar regions are greater, and the wind circulations, both aloft and at the surface, are correspondingly stronger.

Aloft, the circumpolar vortex is large, extending to much lower latitudes. The belt of westerlies is broad. The mean position of the polar front is farther south than in the summer. The tracks of Highs and Lows vary considerably, but many take tracks that are much farther south in winter than in summer.

Due to the intense cooling of land areas, particularly at higher latitudes, many cold high-pressure masses develop over the northern half of the continent. Periodically, these high-pressure cells move southward, bringing polar or arctic air to the rest of the continent. Stormy weather is produced where these cold outbreaks meet warm, moist tropical air. The coldest Highs in North America come from the Hudson

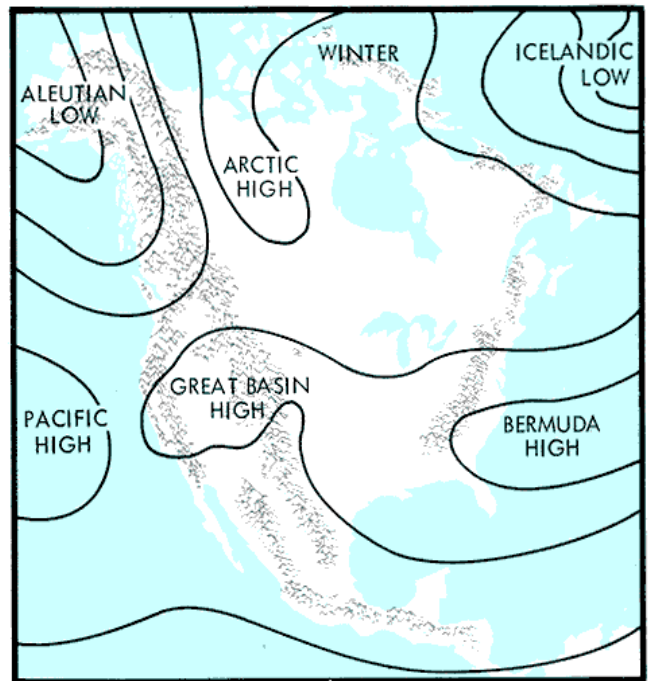

The average January sea-level pressure pattern, representing the winter pattern, shows that the Aleutian and Icelandic Lows are well developed. The Pacific and Bermuda Highs are weaker and farther south than in summer. Pressure is generally high over the cold continent, causing seasonal Highs such as the Great Basin High and the Arctic High to form.

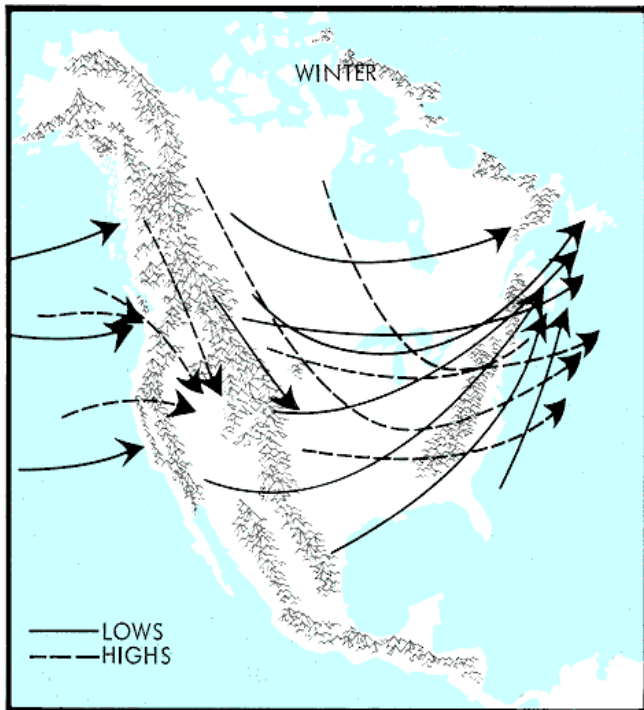

In winter, preferred tracks of migratory Lows and Highs are farther south than in summer. Periodically, a cold high-pressure cell moves southward from the Hudson Bay Region or Northwest Canada. Pacific Highs move eastward across the continent, but often stagnate for a time in the Great basin.

Bay region or Northwest Canada, while milder Highs move in from the Pacific as break off cells from the Pacific High.

SPECIAL CYCLONIC SYSTEMS

Hurricanes, tornadoes, and waterspouts are special forms of low-pressure systems.

Hurricanes cover a vast area and are quite deep. They originate over warm ocean water in the doldrums or in waves in the subtropical easterlies; and produce heavy precipitation and powerful winds. Large amounts of energy are released to feed these systems through the condensation of water vapor. A distinctive feature of these tropical storms is the virtually calm winds and comparatively clear skies at the center, or eye, of the stem. Hurricanes first move toward the west in the easterly flow and later usually turn north and are caught up in the belt of westerlies. They then take on the characteristics of middle-latitude low-pressure systems. They lose intensity rapidly if

Another wintertime feature is the Great Basin High. Cool air masses from either Canada or the Northern Pacific move into the Great Basin and tend to stagnate in this intermountain area. Dry winds, warmed adiabatically as air flows from higher to lower elevations-including the east winds of Washington and Oregon, north winds in northern California, and Santa Ana winds in southern California are associated with the track and positioning of the Great Basin High.

A migratory low-pressure cell, called the **Colorado Low**, often develops east of the central Rockies in winter. The circulation system of this Low usually intensifies as it moves to the northeast, reaching maximum development in the Great Lakes or St. Lawrence River area. This Low is usually accompanied by strong winds and rain or snow. The passage of the Low is followed by northerly winds and a cold high-pressure area from the north moving into the Great Plains or Great Lakes region.

Lows that reach the west coast from the Pacific Ocean sometimes move intact over the mountains and continue in an easterly direction along a path curved toward the northeast. Frequently, however, the track of the Low is discontinuous. The Low fills on the west side of the mountains, then reforms on the east side and resumes its eastward movement.

they move over land because of the increased friction and the loss of the continuous supply of moisture.

Tornadoes and waterspouts are small low-pressure cells in the form of intense spinning vortexes. When they occur, they are associated with severe thunderstorms. Winds near the center of a tornado are commonly 100 to 200 m.p.h. and may exceed 400 m.p.h. The pressure near the center is extremely low. The great destruction of these terrifying storms is due both to the high winds and the explosive effects of a sudden reduction in pressure as the tornado passes. Tornadoes range from 500 to 2,000 feet in diameter and travel over the ground with a speed of 20 to 40 m.p.h. Waterspouts that develop from the cloud downward

are simply tornadoes occurring over the water. waterspouts develop from the water upward, Usually they are not as intense as tornadoes are weak compared to tornadoes, and dissipate

occurring over land. Other "fair weather" rapidly when they move inland.

SUMMARY

In this chapter we have considered the broadscale circulation of the atmosphere, which acts as a gigantic heat engine. The atmosphere is heated by the sun-warmed surfaces in the equatorial regions and is cooled by radiation in the polar regions. Heat is transported from the equatorial regions to the polar regions by the primary circulation and by large-scale atmospheric eddies. Cool air moves from polar regions to low latitudes largely in the form of outbreaks of cold polar air.

Secondary circulations develop because of unequal heating of land and water masses, which, in turn, cause the development of high and low-pressure cells in the atmosphere. The pressure gradients thus produced, along with

the apparent force due to the earth's rotation and other forces, cause the development of characteristic circulations around Highs and Lows and other pressure patterns.

Some Highs and Lows are semi-permanent features of the pressure distribution over the earth; others are migratory and produce rapid weather changes. The movement of the migratory systems is closely related to the meanderings of the belt of westerly winds aloft and of the jet stream imbedded in it.

With this background information on the primary and secondary circulation, we are now ready to consider smaller, more local wind systems that occur within the framework of the larger circulations.

Chapter 6

GENERAL WINDS

The two most important weather, or weather related, elements affecting wildland fire behavior are wind and fuel moisture. Of the two, wind is the most variable and the least predictable. Winds, particularly near the earth's surface, are strongly affected by the shape of the topography and by local heating and cooling. This accounts for much of their variability and is the reason why there is no substitute for an adequate understanding of local wind behavior.

Wind affects wildfire in many ways. It carries away moisture-laden air and hastens the drying of forest fuels. Light winds aid certain firebrands in igniting a fire. Once a fire is started, wind aids combustion by increasing the oxygen supply. It aids fire spread by carrying heat and burning embers to new fuels, and by bending the flames closer to the unburned fuels ahead of the fire. The direction of fire spread is determined mostly by the wind direction. Thus the fire control plan, in the case of wildfire, and the burning plan, in the case of prescribed fire, must be based largely on the expected winds.

GENERAL WINDS

The atmosphere is in continuous motion. In the previous chapter we considered the large scale motions-the primary circulation resulting from the unequal heating of the equatorial and polar regions of the earth, and the secondary circulations around high- and low-pressure areas produced by unequal heating and cooling of land and water masses.

In this chapter and the next we will investigate the local wind-the wind that the man on the ground can measure or feel. Why does it persist or change as it does? Is it related to the general circulation patterns, or is it produced or modified by local influences? We find that local winds may be related to both, and we will discuss them separately.

In this chapter we will consider local winds that are produced by the broadscale pressure gradients which are shown on synoptic weather maps, but may be modified considerably by friction or other topographic effects. We will call these general winds. They vary in speed and direction as the synoptic-scale Highs and Lows develop, move, and decay.

In the next chapter, under the heading of convective winds, we will consider local winds produced by local temperature differences. Certainly all winds are produced by pressure gradients, but the distinction here is that the pressure gradients produced by local temperature differences are of such a small scale that they cannot be detected and diagnosed on ordinary synoptic-scale weather charts.

Wind is air in motion relative to the earth's surface. Its principal characteristics are its direction, speed, and gustiness or turbulence. Wind direction and speed are usually measured and expressed quantitatively, while in field practice turbulence is ordinarily expressed in qualitative or relative terms. Ordinarily only the horizontal components of direction and speed are measured and reported, and this is adequate for most purposes. In fire

weather, however, we should remember that **winds can also have an appreciable vertical component which will influence fire behavior**, particularly in mountainous topography.

At weather stations making regular weather observations, surface **wind direction** is determined by a wind vane mounted on a mast and pointing into the wind. The direction can be determined visually or, with more elaborate instruments, it can be indicated on a dial or recorded on a chart.

Wind direction is ordinarily expressed as the direction **from which** the wind blows. Thus, a north wind blows from the north toward the south, a northeast wind from the northeast, and so on around the points of the compass. Direction is also described in degrees of azimuth from north-a northeast wind is 45° , a south wind 180° , and a northwest wind 315° .

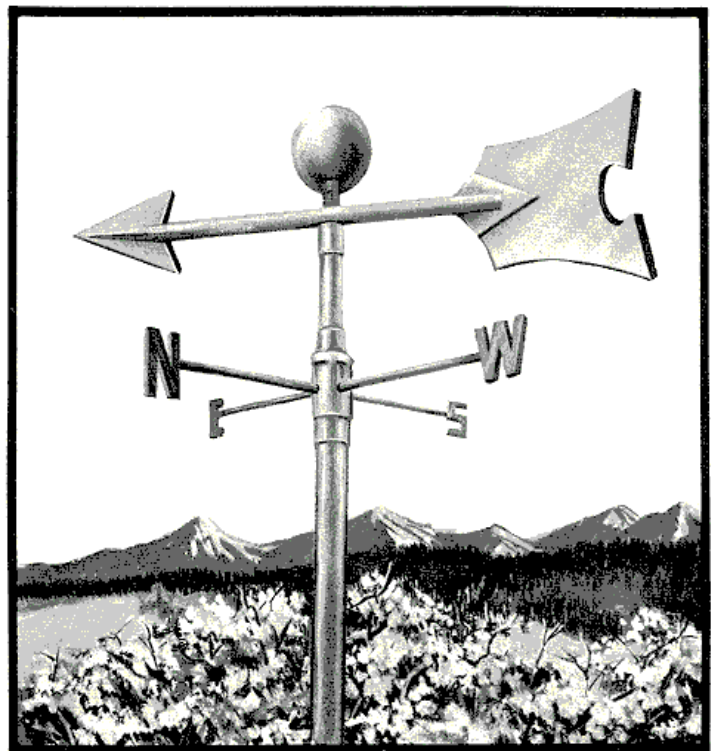

A wind vane indicates wind direction by pointing into the wind-the direction from which the wind blows.

The method of describing the direction of both surface winds and winds aloft, by the direction from which the wind blows, is ordinarily very practical. **In mountain country**, though, surface wind direction with respect to the topography is often more important in fire control and provides a better description of local winds than the compass direction. Here it **is common to express the wind direction** as the direction toward which the wind is headed. Thus, an upslope or upcanyon wind is actually headed up the slope or up the canyon. Wind is described as blowing along the slopes, through the passes, or across the ridges. Similarly, "offshore" or "onshore" are used to describe the directions toward which land and sea breezes are blowing.

Surface wind speeds are measured with **anemometers**. Many types of anemometers are in use, but the most common is the cup anemometer. It indicates either the air speed at any given instant or the miles of air that pass the instrument in a given time period. The latter gives an average wind for the selected time period. Normally, a 2-minute average is used. The standard height at which wind speed is measured is 20 feet above open ground.

In the United States, wind speed is usually measured in miles per hour or knots (nautical miles per hour). One knot is 1.15 miles per hour. Weather Bureau and military weather agencies use knots for both surface and upper winds, while miles per hour is still in common use in many other agencies and operations, including fire weather.

The direction and speed of winds aloft are determined most commonly by tracking an ascending, gas-filled balloon from the surface up through the atmosphere.

The simplest system employs a **pilot balloon** followed visually with a theodolite. If a constant rate of rise of the balloon is assumed, periodic readings of elevation and azimuth angles with the theodolite allow computation of average wind direction and speed between balloon positions. Errors are introduced when the

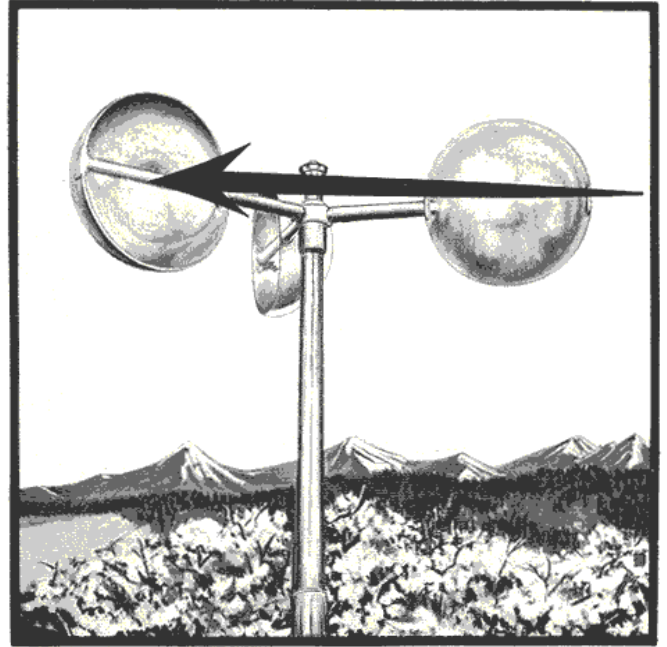

Horizontal wind speed is measured by the rate of rotation of a cup anemometer.

ascent rate is not constant because of vertical air currents. If a radiosonde unit (which transmits temperature, moisture, and pressure data during ascent) is added to the balloon, the height of the balloon at the time of each reading can be calculated fairly accurately, and the computed winds are more accurate.

The most refined of present systems has the further addition of a self-tracking, radio direction-finding unit that measures elevation and azimuth angles, and slant range from the observing station to the balloon. This unit, known as a **rawinsonde**, yields quite accurate upper-air information. All of these methods furnish wind **soundings** for meteorological use and interpretation.

The speed and direction of upper winds are sampled at regular intervals each day at selected weather stations across the continent. These stations are often more than 100 miles apart. Although winds aloft tend to be more uniform than surface winds, there are exceptions. The wind structure over an area some distance from a sampling station may differ considerably from that indicated by the nearest sounding.

MECHANICAL AND THERMAL TURBULENCE

either mechanical or thermal in

We learned in the previous chapter that friction with the earth's surface slows down the wind and results in changes of direction so that the surface wind blows at an angle across the isobars from high to low pressure. The amount of reduction in speed and change of direction depends upon the roughness of the earth's surface. It follows then that the effect of friction is least over smooth water and greatest over mountainous topography.

The depth of the air layer through which the frictional force is effective also varies with the roughness of the surface; it is shallower over smooth surfaces and deeper over rough topography. The depth may also vary with the stability of the lower atmosphere. A low inversion will confine the frictional effect to a shallow surface layer, but a deep layer can be affected if the air is relatively unstable. These effects vary widely both with time and between localities.

Usually the friction layer is considered to be about 2,000 feet deep. The top of the friction layer is the gradient wind level above which the windflow tends to parallel the isobars or Pressure-surface contours.

Surface winds often vary considerably in both speed and direction over short intervals of time. They tend to blow in a series of gusts and lulls with the direction fluctuating rapidly. This irregular air motion is known as **turbulence**, which may be

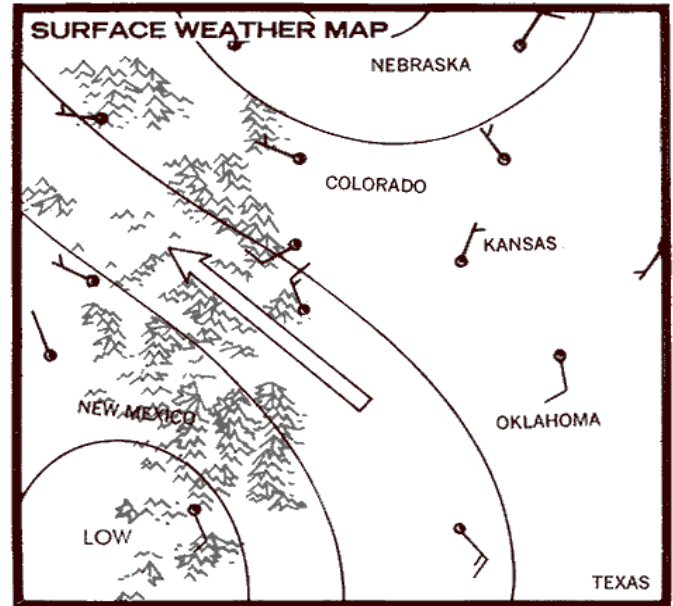

The wind direction at surface stations may differ widely from the windflow above the friction layer, as shown by this weather map. Surface wind direction is indicated on weather maps by a wind arrow flying with the wind. The number of barbs on the tail represent the wind speed. At the top of the friction layer the wind blows parallel to the isobars, as shown by the large arrow.

nature. At the surface, turbulence is commonly identified in terms of eddies, whirls, and gusts; aloft it is associated with "bumpy" flying.

Surface friction produces mechanical turbulence in the airflow. The flow of stable air



Roughness creates mechanical turbulence, while surface heating causes thermal turbulence in the airflow.

near the surface is similar to the flow of water in a creekbed. At low speeds the currents of air tend to follow the general contours of the landscape. But when the speed increases—as when a creek rises—the current “tumbles” over and around hills and ridges, structures, trees, and other obstacles, and sets up eddies in all directions. Mechanical turbulence increases with both wind speed and the roughness of the surface.

Thermal turbulence is associated with instability and convective activity. It is similar to mechanical turbulence in its effects on surface winds, but extends higher in the atmosphere. Since it is the result of surface heating, thermal turbulence increases with the intensity of surface heating and the degree of instability indicated by the temperature lapse rate. It therefore

shows diurnal changes, and **is most pronounced in the early afternoon** when surface heating is at a maximum and the air is unstable in the lower layers. It is at a minimum during the night and early morning when the air is more stable. Mechanical and thermal turbulence frequently occur together, each magnifying the effects of the other.

Thermal turbulence induced by the combination of convection and horizontal wind is the principal mechanism by which energy is exchanged between the surface and the winds aloft. Unstable air warmed at the surface rises to mix and flow along with the winds above. This turbulent flow also brings air with higher wind speeds—greater momentum—from aloft down to the surface, usually in spurts and gusts. This momentum exchange increases the aver-

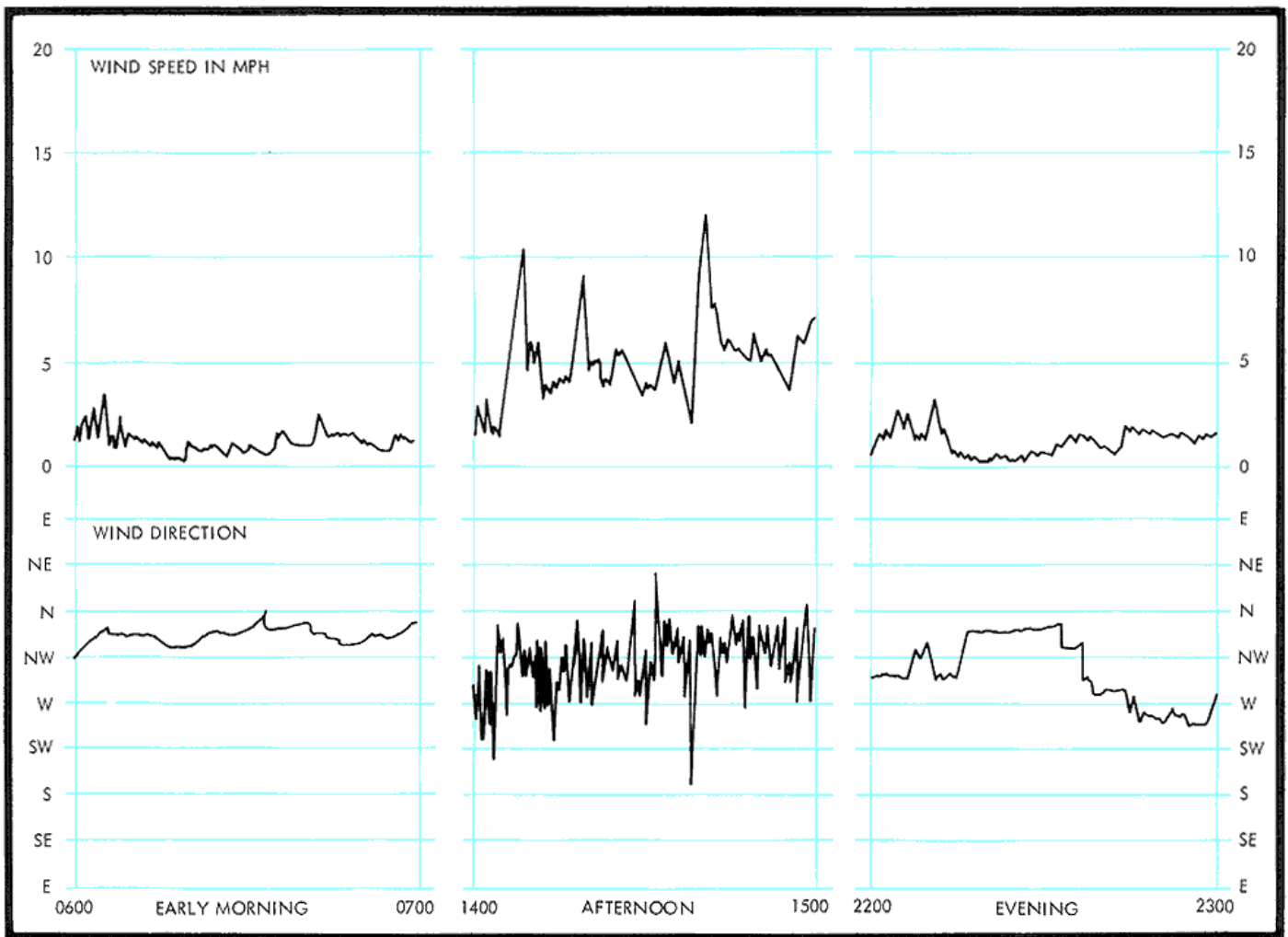

On clear days over flat terrain, thermal turbulence, as indicated by the fluctuations in wind speed and direction, shows diurnal changes because of day heating and night cooling. Turbulence is most pronounced in early afternoon when surface heating is maximum and the lower layers of air are unstable, and least pronounced during the night and early morning when air is stable.



Thermal turbulence caused by surface heating is a mechanism by which energy is exchanged between the surface and the flow aloft. This mixing brings higher wind speeds from aloft down to the surface, usually in spurts and gusts.

age wind speed near the surface and decreases it aloft. It is the reason why surface winds at most places are stronger in **the afternoon than** at night.

Eddy formation is a common characteristic of both mechanical and thermal turbulent flow. Every solid object in the wind path creates eddies on its lee side. The sizes, shapes, and motions of the eddies are determined by the size and shape of the obstacle, the speed and direction of the wind, and the stability of the lower atmosphere. Although eddies may form in the atmosphere with their axes of rotation in virtually any plane, it is usual to

distinguish between those which have predominantly vertical or horizontal axes. A whirlwind or dust devil is a vertical eddy, as are eddies produced around the corners of buildings or at the mouths of canyons with steep sides. Large, roughly cylindrical eddies that roll along the surface like tumbleweeds are horizontal eddies.

Eddies associated with individual fixed obstructions tend to remain in a more-or-less stationary position in the lee of the obstruction. If they break off and move downstream, new ones form near the obstruction. The distance

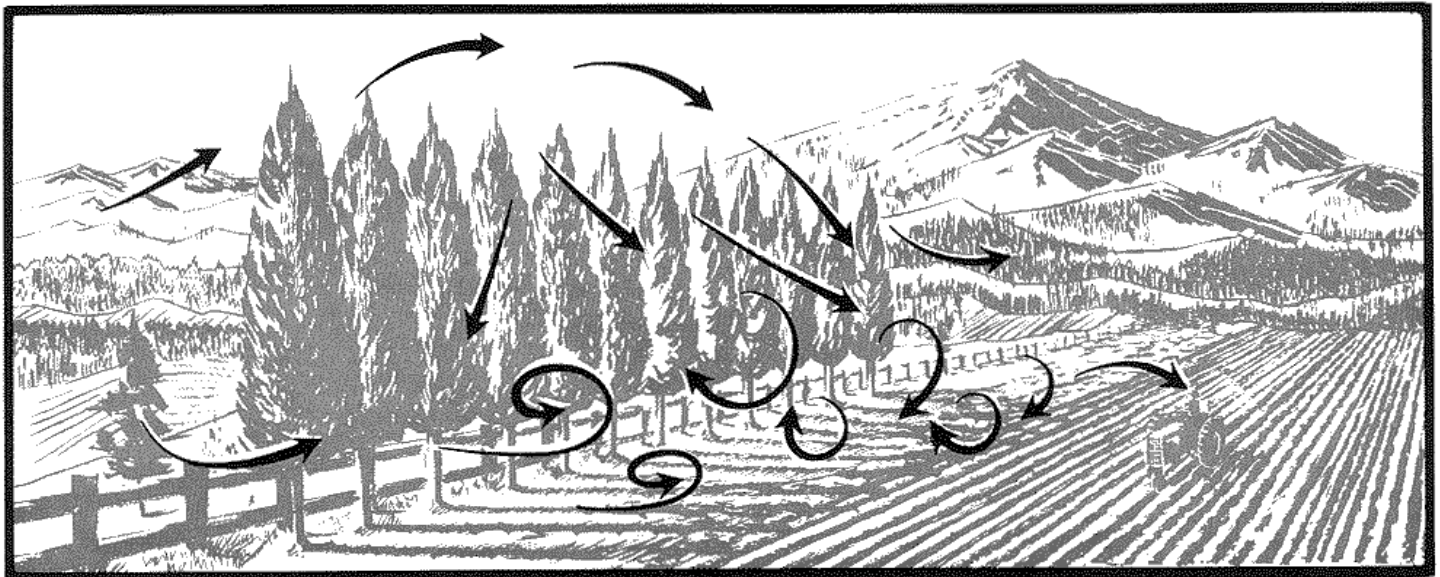

Eddies form as air flows over and around obstacles. They vary with the size and shape of the obstacle, the speed and direction of the wind, and the stability of the lower atmosphere.

downwind that an obstacle, such as a windbreak, affects the windstream is variable. For most obstructions, the general rule of thumb is that this distance is 8 to 10 times the height of the obstacle.

Rotation speeds in eddies are often much greater than the average wind speeds measured with mechanical anemometers. These higher speeds are often of short duration at any point, except where stationary eddies are found, but are still significant in fire behavior. Whirlwinds, for example, develop speeds capable of lifting sizable objects. Eddies moving with the general windflow account for the principal short-term changes in wind speed and direction known as gustiness.

The absence of turbulence—a steady even flow—is called laminar flow. The term suggests air moving along in flat sheets or layers, each

successive thin layer sliding over the next. Laminar or near-laminar flow occurs in stable air moving at low speeds. It is characteristic of cold air flowing down an incline, such as we might find in a nighttime inversion. The air flows smoothly along, following the topography and varying little in speed. Vertical mixing is negligible.

True laminar flow is probably rare in wildland fire situations, but, on occasion, turbulence is minor and, for all practical purposes, surface winds do have the steady speed and direction characteristic of laminar motion. While turbulent winds usually cause more erratic fire behavior, the laminar type may result in more rapid and sustained fire spread in one direction. Laminar flow is most likely to occur at night. It is frequently observed over open plains and gently rolling topography.

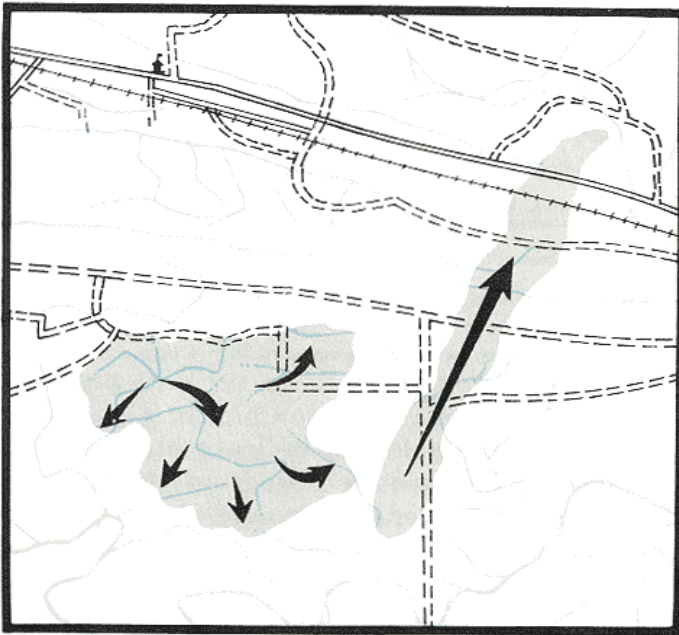

The nature of the wind during a wildfire is shown by the shape of the burned area. Turbulent winds usually cause more erratic fire behavior and firespread in many directions, while laminar flow is likely to result in spread in one direction.

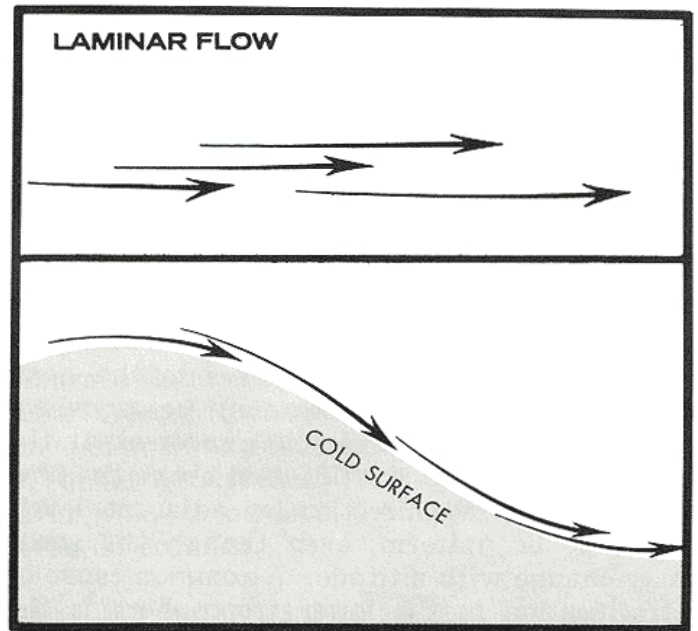

In laminar flow there is little mixing. The air flows smoothly along, one layer seeming to slide over the next. Laminar flow is characteristic of cold air flowing down an incline.

WINDS ALOFT

Wildland fires of low intensity may be affected only by the airflow near the surface. But when the rate of combustion increases, the upper airflow becomes important as an influence on fire behavior. Airflow aloft may help or hinder the development of deep

convection columns. It may carry burning embers which ignite spot fires some distance from the main fire. The winds aloft may be greatly different in speed and direction from the surface winds.

Usually, we separate winds into **surface winds and winds aloft**. There is no sharp separation between them, but rather a blending of one into the other. We think of surface winds as those winds measured with instruments mounted on surface-borne masts or towers. Winds aloft are those measured with airborne equipment from the surface layer up to the limit of our interest. In ascending from the surface through the lower atmosphere, there is a transition in both speed and direction from the surface to the top of the **friction layer**, which is also called the mixing layer. The depth of this friction or mixing layer is, as we saw when we considered the effects of friction dependent upon the roughness of the terrain and the intensity of heating or cooling at the surface. The winds aloft above the mixing layer are more steady in speed and direction, but they do change as pressure centers move and change in intensity.

Pressure systems higher in the troposphere may differ markedly from those near the surface. At progressively higher altitudes, closed pressure systems are fewer. Furthermore, it is common for the troposphere to be **stratified or layered**. With height, there may be gradual changes in the distribution of Highs and Lows. These changes produce different wind speeds and directions in the separate layers. With strong stratification the wind direction may change abruptly from one layer to the next. The difference in direction may be anywhere from a few degrees to complete reversal. In the absence of marked stratification above the friction layer, wind direction at adjacent levels tends to be uniform, even though the speed may change with altitude. A common cause of stratification in the lower troposphere is the overriding or underrunning of one air mass by another. Thus, the layers often differ in temperature, moisture, or motion, or in any combination of these.

Wind Profiles

Marked changes in either wind speed or direction between atmospheric layers often occur with an inversion which damps or prevents vertical motion, whether it is convection over a fire or natural circulation in the formation of cumulus clouds. Even though a **wind speed profile—a plot of wind speed against height**—

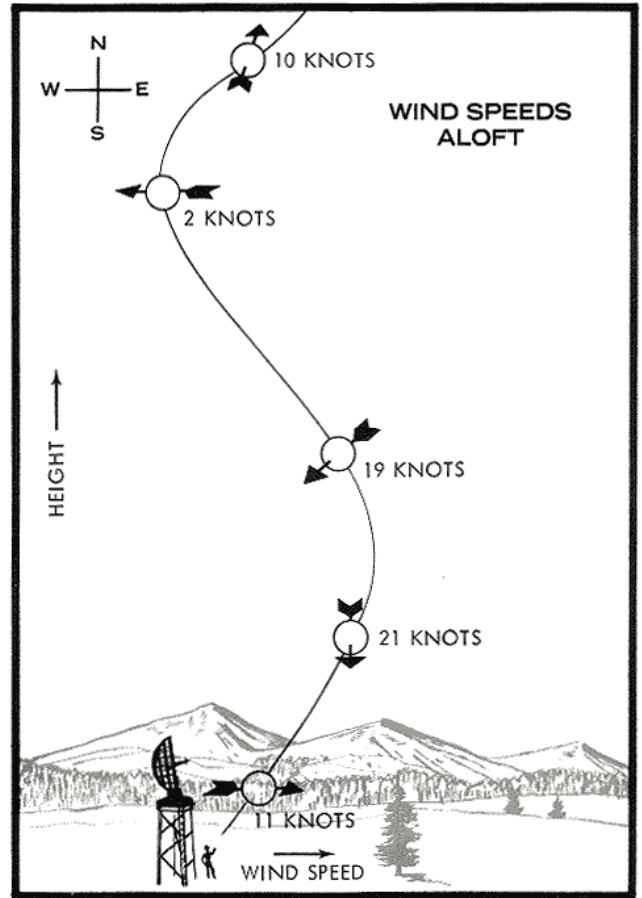

Wind speeds and directions aloft in a stratified atmosphere may vary from one layer to the next. The arrows indicate horizontal directions according to the compass card in the upper left.

of the upper air might indicate only nominal air speeds, the relative speeds of two air currents flowing in nearly opposite directions may produce strong wind shear effects. **Wind shear** in this case is the change of speed or direction with height. Clouds at different levels moving in different directions, tops being blown off growing cumulus clouds, and rising smoke columns that break off sharply and change direction are common indicators of wind shear and disrupted vertical circulation patterns.

Local winds-aloft profiles commonly fall into one or another of several general types. The accompanying illustrations show four types. The soundings were taken on different days at one station and reveal some characteristic differences in winds-aloft patterns. One profile is characteristic of a well-mixed atmosphere without distinct layers. In another, wind shear

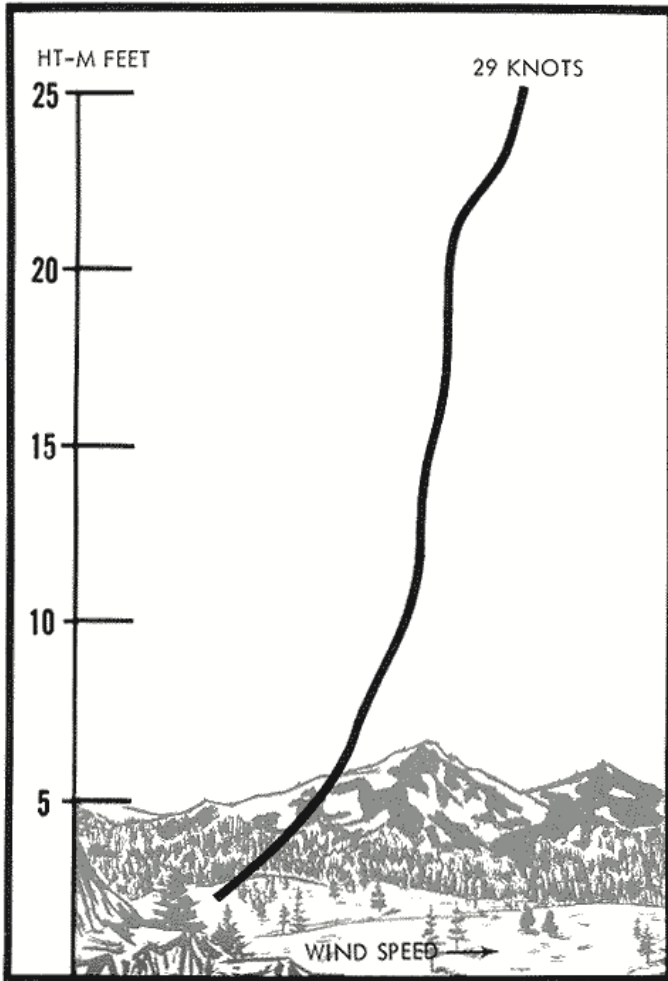

A wind profile without abrupt changes in wind speed or direction is characteristic of a well-mixed atmosphere,

is found in a region of abrupt change in wind speed, and in another wind shear is the result of a sharp change in direction. An interesting feature of the fourth is the occurrence of a **low-level jet** wind near the surface with relatively low wind speeds above.

Low-level jets are predominantly Great Plains phenomena although they do occur in other areas. A layered structure of the lower few thousand feet of the atmosphere appears to favor their formation. In fair weather, this strongly suggests a greater probability of occurrence at night than during the day. Stratification in the first few thousand feet is discouraged by daytime heating and thermal mixing, and encouraged by cooling from the surface at night. For example, these jets have been observed to reach maximum speeds in the region just above a night inversion. They have not been studied in rough mountain topography; however, the higher peaks and ridges

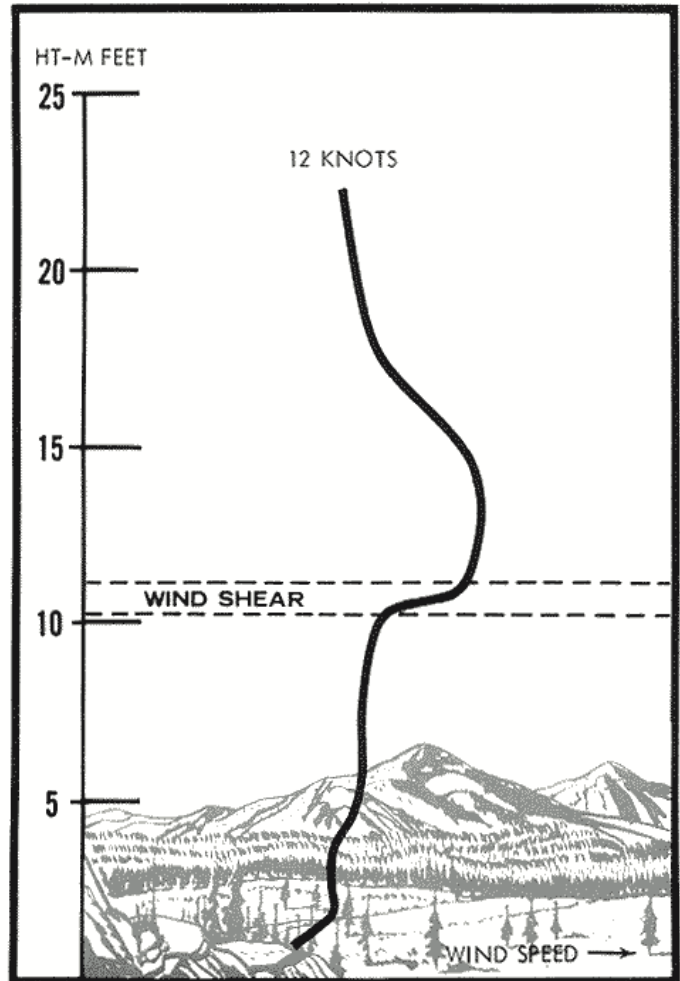

Wind shear occurs where wind speeds change abruptly.

above lowland night inversions may occasionally be subjected to them. A jet within the marine inversion in the San Francisco Bay area is a frequent occurrence. The geographic extent over which a low-level jet might occur has not been determined.

FRONTAL WINDS

The variability of general surface winds during the spring and fall fire seasons is somewhat greater in eastern portions of the continent than during the summer fire season of the mountainous West. The East experiences more frequent and rapid movement of pressure systems than occur in the West. In the West, the major mountain chains tend both to hinder the movement of Highs and Lows and to lift winds associated with them above much of the topography. Strong summer surface heating also diminishes the surface effects of these changes.

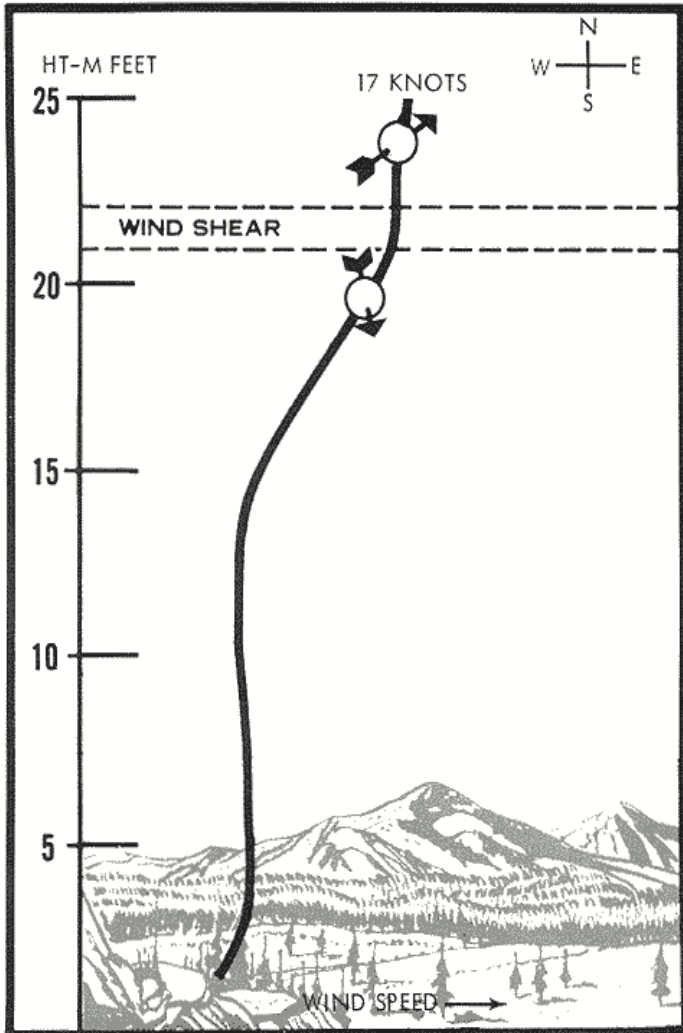

A sharp change in direction also causes wind shear. Shear layers usually indicates that the atmosphere is stratified into layer.

As successive air masses move across the land, the change from one to another at any given point is marked by the passage of a front. A front is the boundary between two air masses of differing temperature and moisture characteristics. The type of front depends upon the movement of the air masses.

Where a cold air mass is replacing a warm air mass, the boundary is called a cold front. Where a warm air mass is replacing a cold air mass, the boundary is called a **warm front**. If a cold front overtakes a warm front, the intervening warm air is lifted from the surface, and the air mass behind the cold front meets the air mass ahead of the warm front. The frontal boundary between these two air masses is then called an **occlusion or occluded front**.

In chapter 8 we will consider in detail the kinds of air masses and fronts, and their associated

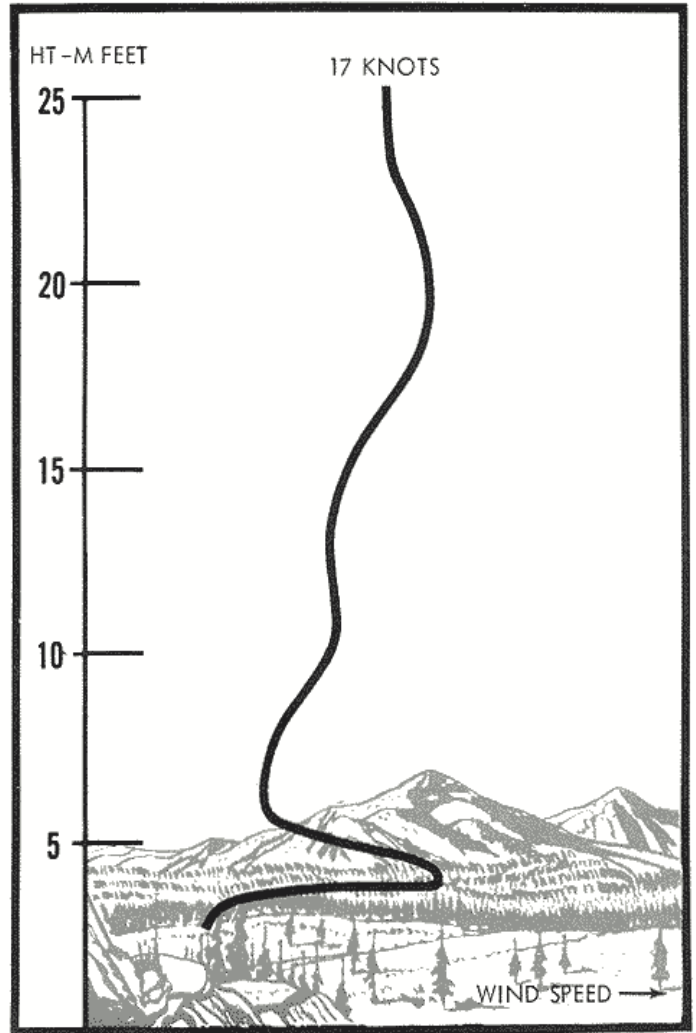

Low-level jets occur predominately in night wind profiles in the Plains, but they may also occur elsewhere. The jet is found most frequently just above the night inversion.

weather. Here, we are concerned only with the general surface winds that accompany frontal passages.

Fronts are most commonly thought of in association with precipitation and thunderstorms. But occasionally fronts will cause neither. In these instances, the winds accompanying the frontal passage may be particularly significant to fire behavior.

The passage of a front is usually accompanied by a **shift in wind direction**. The reason for this is that fronts lie in troughs of low pressure. We learned in the previous chapter that the isobars in a trough are curved cyclonically in the Northern Hemisphere. This means that as a trough, with its front, passes a particular location the wind direction shifts clockwise. The wind behavior during the frontal passage depends upon the type of front, its

speed, the contrast in temperature of the air masses involved, and upon local conditions of surface heating and topography.

East of the Rockies, the surface wind ahead of a warm front usually blows from a southeasterly or southerly direction. With the frontal passage, the wind gradually shifts clockwise. The change in wind direction usually amounts to between 45° and 90°; therefore, after the warm front goes by, the wind commonly blows from the southwest. Steady winds, rather than gusty winds, both before and after the frontal passage are the rule, because the layer of air next to the ground is generally stable. Warm-front passages in the mountainous West are fewer, more erratic, and tend to become diffuse.

The passage of a cold front differs from that of a warm front. The wind change is usually sharp and distinct, even when the air is so dry that few if any clouds accompany the front. Ahead of a cold front, the surface wind is usually from the south or southwest. As the front approaches, the wind typically increases in speed and often becomes quite gusty. If cold air aloft overruns warm air ahead of the front at the surface, the resulting instability may cause violent turbulence in the frontal zone.

The wind shift with the passage of a cold front is abrupt and may be less than 45° or as much as 180°.

After the front has passed, the wind direction is usually west, northwest, or north. Gustiness may continue for some time after the frontal passage, because the cooler air flowing over warmer ground tends to be unstable. This is particularly true in the spring months. If the temperature contrast is not great, however, the winds soon become steady and relatively gentle.

The wind shift accompanying the passage of an occluded front is usually 90° or more. The wind generally shifts from a southerly direction to a westerly or northwesterly direction as the occlusion passes. The wind shift with an occlusion resembles that of a warm front or cold front, depending upon whether the air behind the occlusion is warmer or colder than the air ahead. The violent turbulence that may accompany a cold-front passage, however, is usually absent with an occluded frontal passage.

In the area east of the Rockies, squall lines often precede cold fronts. These are narrow zones of instability that usually form ahead of and parallel to the cold front. Most common in

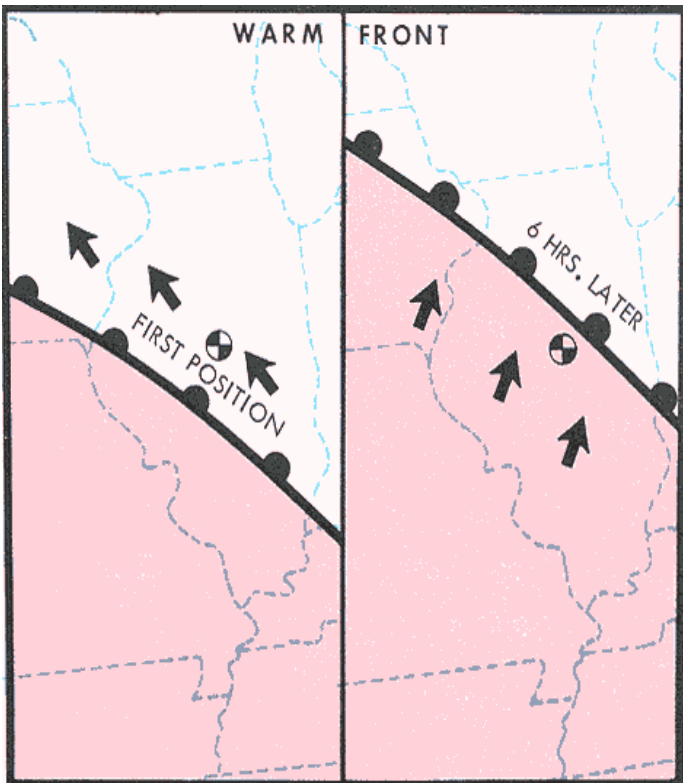

As a warm front passes, wind is steady and shifts gradually, usually from a southeasterly to a southwesterly direction.

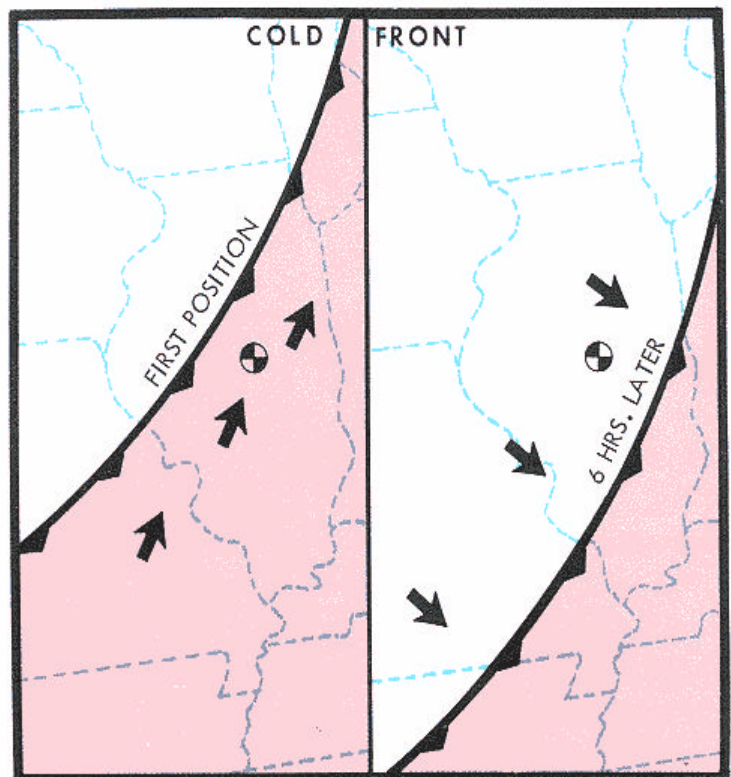

Winds increase ahead of a cold front, become gusty and shift abruptly, usually from a southwesterly to a northwesterly direction, as the front passes.

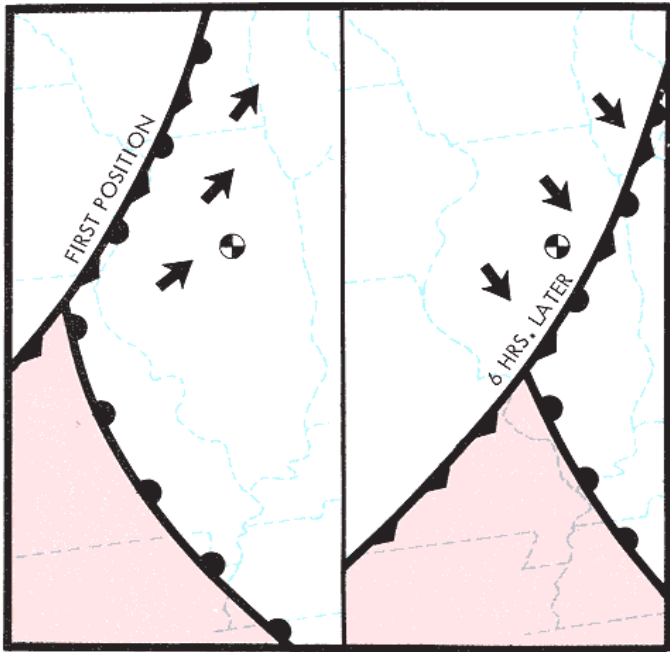

The wind shift accompanying the passage of an occluded front is usually 90° or more, generally from a southerly to a westerly or northwesterly direction.

the spring and summer, squall lines are associated with severe lightning storms in the Midwest and may have extremely violent surface winds. They usually develop quickly in the late afternoon or night, move rapidly, and tend to die out during late night or early morning,

Winds ahead of the squall are usually from a southerly direction. They increase to 30, 40, or even 60 miles per hour, shift to the west or northwest, and become extremely gusty as the squall line passes. The strong, gusty winds ordinarily do not last long, and the winds soon revert to the speed and direction they had prior to the squall. This wind behavior distinguishes a squall line from a cold front.

Squall lines are usually accompanied by thunderstorms and heavy rain. But occasionally the storms are scattered along the line so that any one local area might experience squall-line wind behavior without the fire-quenching benefit of heavy rain.

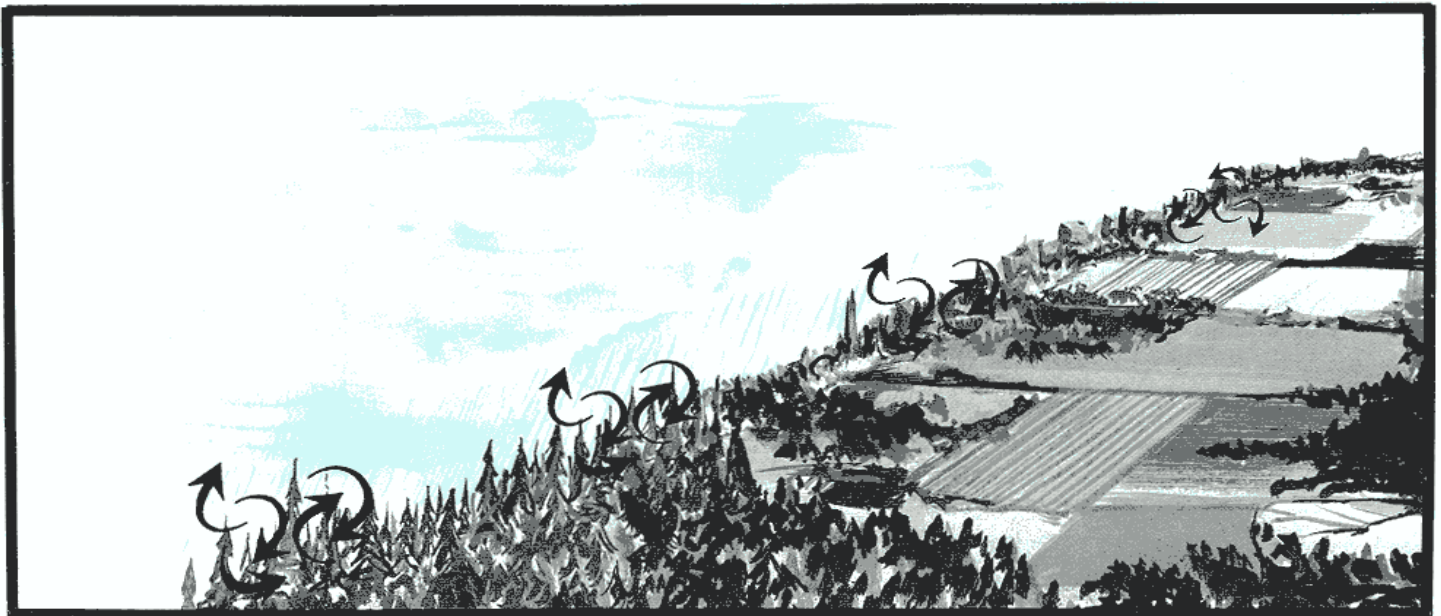

Squall lines produce violently turbulent winds, usually for a few minutes.

EFFECTS OF MOUNTAIN TOPOGRAPHY

Mountains represent the maximum degree of surface roughness and thus provide the greatest friction to the general surface airflow.

Mountain chains are also effective as solid barriers against airflow – particularly dry, cold air of polar origin and relatively cool Pacific marine air.

While warm, light air may be forced aloft and flow over the ranges, cool, heavy air is often either dammed or deflected by major mountain systems.

Over short distances and rough topography, gradient balance may not be established and winds of considerable speed may blow almost directly across isobars from higher to lower pressure. Winds of this nature are common in both coastal and inland mountain regions. This type of flow is particularly noticeable in the strong pressure-gradient region of a Santa Ana pattern.

Mountains and their associated valleys provide important channels that establish local wind direction. Airflow is guided by the topography into the principal drainage channels. Less-prominent features of the landscape have similar, though smaller scale, local mechanical effects on wind speed, direction, and turbulence. In short, winds blowing over the surface are influenced by every irregularity.

In addition to these mechanical effects, strong daytime convective activity in mountain areas often alters or replaces the general wind at the surface. General winds are most pronounced

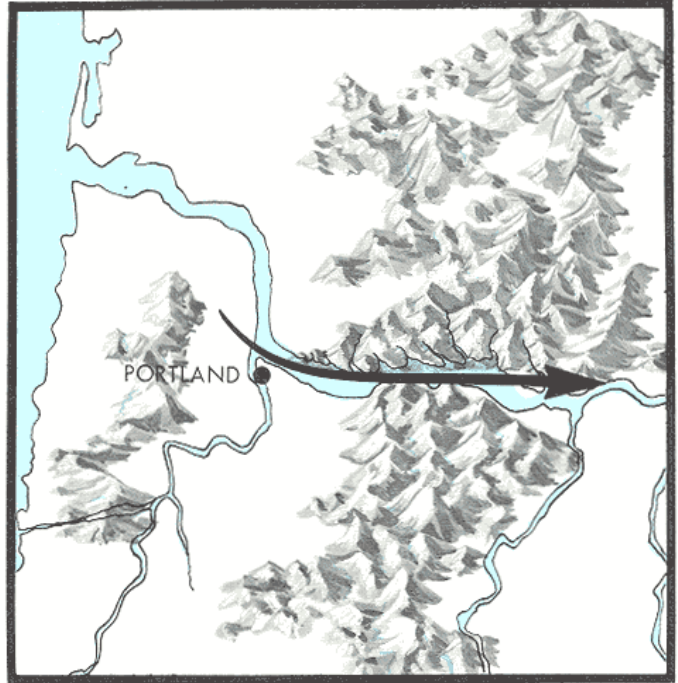

Deep gorges in mountain ranges channel surface airflow.

at the surface in the absence of strong heating.

General winds blowing across mountain ridges are lifted along the surface to the gaps and crests. If the air is stable, it will increase in speed as it crosses the ridge. Ridgetop winds thus tend to be somewhat stronger than winds in the free air at the same level.

How the air behaves on crossing a ridge is influenced by ridge shape and wind speed and direction. **Round-topped** ridges tend to disturb surface airflow the least. In light to moderate winds there is often little evidence of any marked turbulence. Sharp ridges, on the other hand, nearly always produce significant turbulence and numerous **eddies** on the lee side. Some of this is evident at the surface as gusts and eddies for short distances below the ridgetop, though much of it continues downwind aloft. Wind blowing perpendicular to the ridge line develops the least complex wind structure downwind, and most of the eddies formed are of the roll or horizontal type. If the angle of wind approach deviates from the perpendicular by some critical amount, perhaps 30° or less, vertical eddies are likely to be found in the lee draws below the ridgetop, in addition to eddies in other planes.

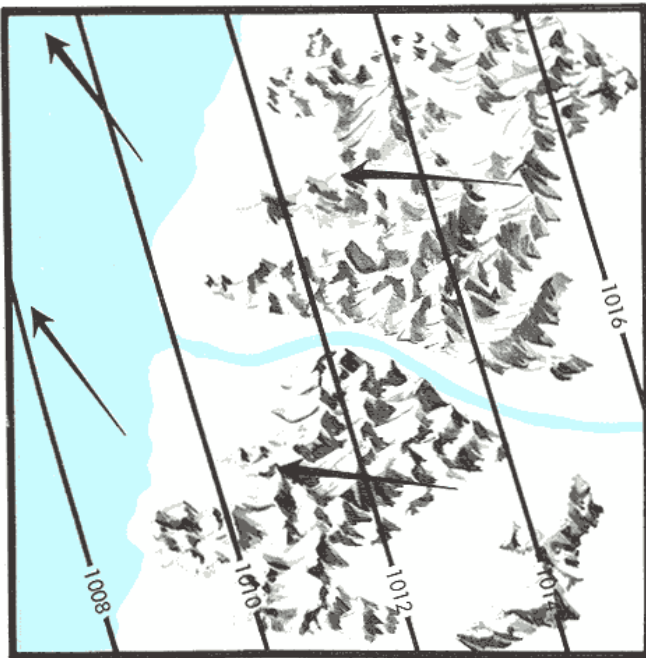

Over rough topography, large frictional effects may cause surface winds to blow almost directly across the isobars from high to low pressure. Where friction is less, such as over water, surface wind directions have only a small angle across the isobars.

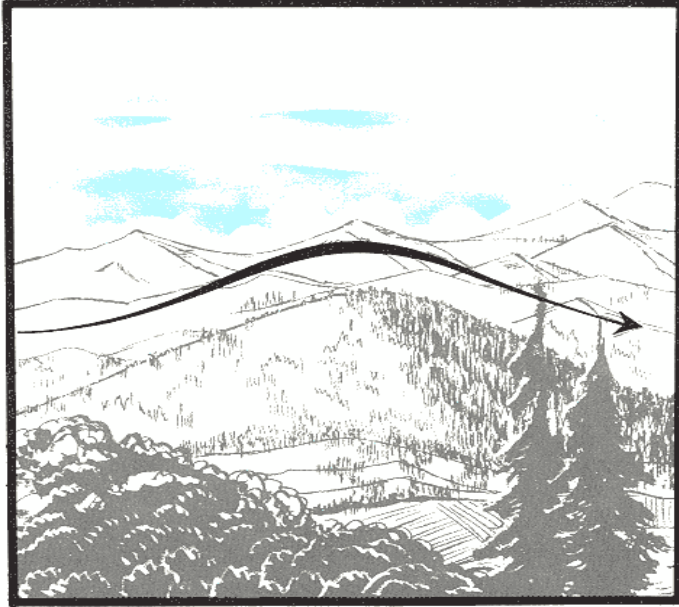

Airflow crossing a ridge is influenced by the ridge shape and by the wind speed and direction. Rounded hills disturb wind flow the least. In light to moderate winds, there may be no marked turbulence.

Eddy currents are often associated with bluffs and similarly shaped canyon rims. When a bluff faces downwind, air on the lee side is protected from the direct force of the wind flowing over the rim. If the wind is persistent,

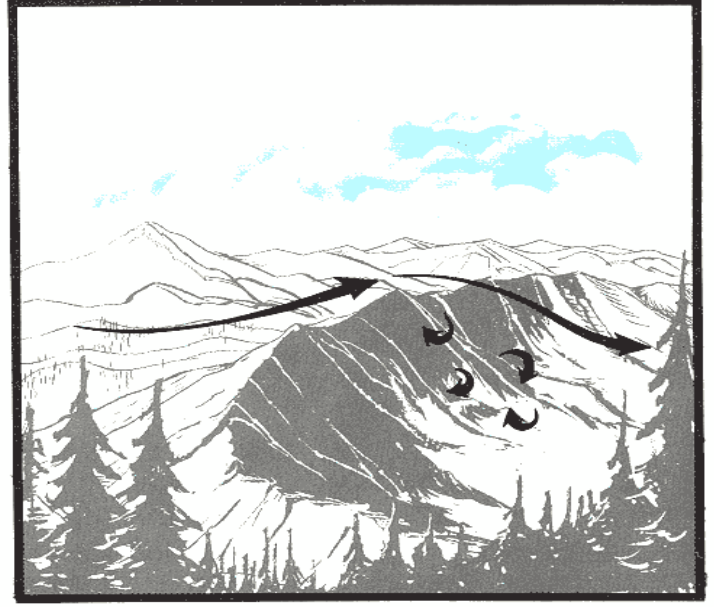

Higher wind speeds and sharp ridges cause turbulence and eddies on the lee side.

however, it may start to rotate the air below and form a large, stationary roll eddy. This often results in a moderate to strong upslope wind opposite in direction to that flowing over the rim. Eddies of this nature are common in

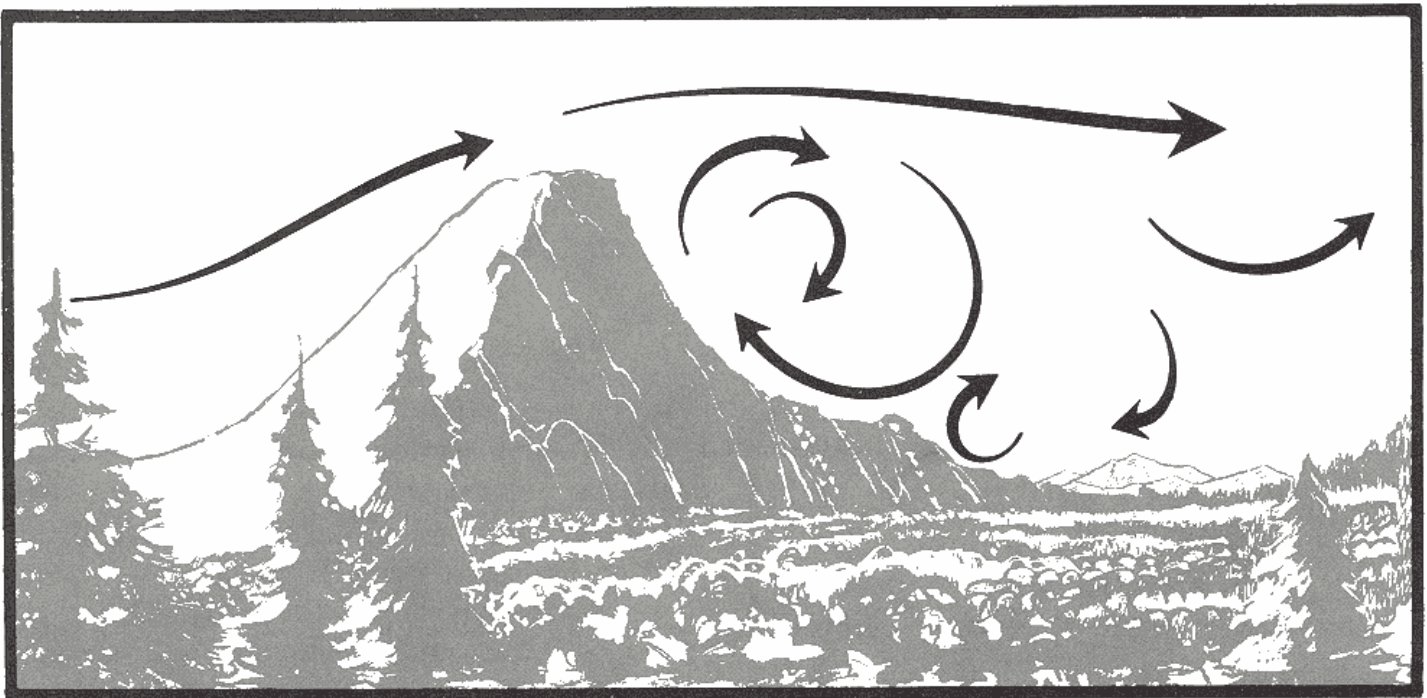

Large roll eddies are typical to the lee of bluffs or canyon rims. An upslope wind may be observed at the surface on the lee side.

the lee of ridges that break off abruptly, and beneath the rims of plateaus and canyon walls.

Ridgetop saddles and mountain passes form important channels for local pressure gradient winds. Flow converges here as it does across ridgetops, with an accompanying increase in wind speed. After passing through mountain saddles, the wind often exhibits two types of eddy motion on the lee side. One takes the form of horizontal eddies rolling or tumbling down the lee slope or canyon, although the main eddy may be stationary. The other is usually a stationary vertical eddy in one of the sheltered areas on either side of the saddle. Some of these vertical eddies may also move on downwind.

General winds that are channeled in mountain canyons are usually turbulent. The moving air is in contact with a maximum area of land surfaces. Alternating tributaries and lateral ridges produce maximum roughness. Whether the canyon bottom is straight or crooked also has an important influence on the turbulence to be expected. Sharp bends in mountain-stream courses are favorite "breeding grounds" for eddies, particularly where the canyon widens to admit a side tributary. Such eddies are most pronounced near the canyon floor and dissipate well below the ridgetop.



Eddies form where strong flow through canyons. Favorite places are bends in the canyons and mouths of tributaries.

Mountain Waves

Moderate to strong winds in a stably stratified atmosphere blowing across high mountain ranges will cause large-scale **mountain waves** for many miles downwind. The stable air, lifted by the wind over the mountain range, is pulled



Ridgetop saddles and mountain passes form important channels for general wind flow. The flow converges and the wind speed increases in the passes. Horizontal and vertical form on the lee side of saddles.

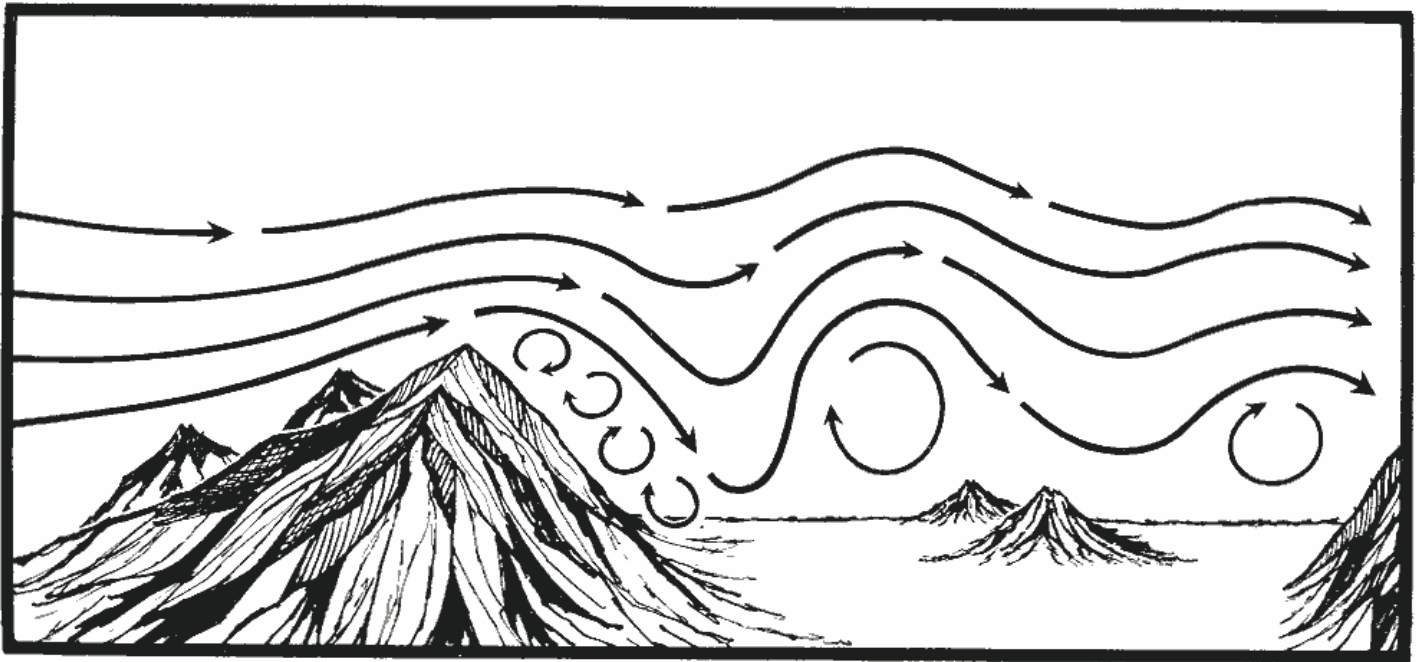

Mountain waves form when strong winds blow perpendicular to mountain ranges. Considerable turbulence and strong updrafts and downdrafts are found on the lee side. Crests of waves may be marked by lens-shaped wave clouds, but at times there may be insufficient moisture to form clouds.

downward by gravity on the lee side. Inertia carries the air past its equilibrium level, so it rises again farther downslope. This oscillatory motion forms a series of lesser waves downstream until the oscillation finally ceases. Waves may extend as high as 40,000 feet or more in the well-known Bishop wave in California. Large-scale waves occur in the Rocky Mountains, and waves on a lesser scale appear in the Appalachians and elsewhere.

The lee slope of the mountains may experience strong downslope winds or many eddies of various sizes which roll down the slope. Within

each wave downstream from the mountain range, a large roll eddy may be found with its axis parallel to the mountain range. Roll eddies tend to be smaller in each succeeding wave downstream. The waves downwind of the mountains are referred to as lee waves or standing waves.

If sufficient moisture is present, cap clouds will form over the crest of the mountains, roll clouds will be found in the tops of the roll eddies downstream, and wave clouds will be located in the tops of the waves.

FOEHN WINDS

Foehn winds represent a special type of local wind associated with mountain systems. In most mountainous areas, local winds are observed that blow over the mountain ranges and descend the slopes on the leeward side. If the down flowing wind is warm and dry, it is called a foehn wind. The wind is called a bora or fall wind if the air is originally so cold that even after it is warmed adiabatically in flowing down the mountain slopes it is still colder than the air it is replacing on the leeward side. The been rarely occurs in North America and is not

important in this discussion, because of its cold temperatures and the fact that the ground is often snow-covered when it occurs. We are concerned more with the warmer foehn, which creates a most critical fire-weather situation.

The development of a foehn wind requires a strong high-pressure system on one side of a mountain range and a corresponding Low or trough on the other side. Such pressure patterns are most common to the cool months; therefore, foehn winds are more frequent in the period from September through April than

in the summer months. **Two types** of foehn winds are common in our western mountains.

Foehn winds of the first type result when a deep layer of moist air is forced upward and across a mountain range. As the air ascends the windward side, it is cooled dry-adiabatically until the condensation level is reached. Further lifting produces clouds and precipitation, and cooling at the lesser moist adiabatic rate. The water vapor that has condensed and fallen out as precipitation is lost to the air mass. Upon descending the leeward slopes, the air mass warms first at the moist-adiabatic rate until its clouds are evaporated. Then it warms at the dry-adiabatic rate and arrives at lower elevations both warmer and drier than it was at corresponding levels on the windward side. In descending to the lowlands on the leeward side of the range, the air arrives as a strong, gusty, desiccating wind.

Moist Pacific air forced across the Sierra - Cascade range loses some of its moisture and exhibits mild foehn characteristics on the eastern slopes. Forced across the Rocky Mountain range, the same air loses additional moisture and may produce a well-developed foehn on the eastern slopes in that region. The Plains east of the Rockies are often under the influence of a cold air mass of Canadian origin in the cooler months. If this air mass is then moved eastward by a favorable pressure gradient and replaced by a warm descending foehn, abrupt local temperature rises are experienced.

The **second** type of fusion is related to a cold, dry, usually stagnated high-pressure air mass restricted by mountain barriers. If a low pressure center or trough is located on the opposite side of the barrier, the strong pressure gradient will cause air to flow across the mountains. Since the mountains block the flow of surface air, the airflow must come from aloft. The air above the surface high-pressure system is subsiding air and is therefore dry and potentially quite warm. On the leeward side of the mountains, surface air is forced away by the strong pressure gradient, and it is replaced by the air flowing from aloft on the windward side and descending to the lowland on the leeward side. Surface wind speeds of 40 to 60 miles per hour are common in foehn flow of this type, and speeds up to 90 miles per hour have been reported

The wind often lasts for 3 days or more, with gradual weakening after the first day or two. Sometimes, it stops very abruptly.

High-pressure areas composed of cool air masses frequently stagnate in the Great Basin of the Western United States during the fall, winter, and spring months. Depending on its location, and the location of related Lows or troughs, a Great Basin High may create foehn winds which move eastward across the northern and central Rockies, westward across the Oregon and Washington Cascades and the northern and central Sierra Nevada, or southwestward across the Coast Ranges in southern California. A combination of high pressure over the State of Washington and low pressure in the Sacramento Valley causes north winds in northern California. Brief foehn wind periods, lasting 1 or 2 days, may result from migrating Highs passing through the Great Basin.

The course of the foehn may be either on a front many miles wide or a relatively narrow, sharply defined belt cutting through the lee-side air, depending on the pressure pattern and on the topography.

A foehn, even though it may be warm, often replaces cooler air on the lee side of the

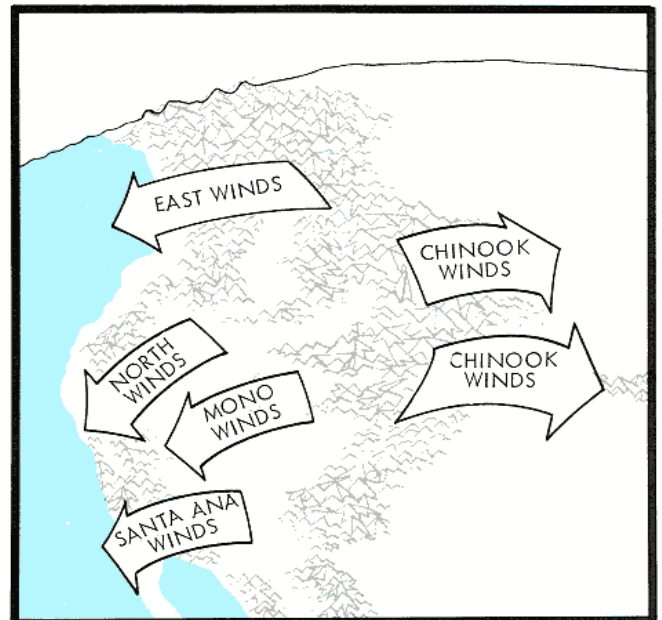

Foehn winds are known by different names in different parts of the mountains West. In each case, air is flowing from a high-pressure area on the windward side of the mountains to a low-pressure area on the leeward side.

mountains. Counterforces sometimes prevent this, however, and cause the foehn to override the cooler air and thus not be felt at the surface at lower elevations. At other times the foehn may reach the surface only intermittently, or at scattered points, causing short-period fluctuations in local weather.

Two mechanisms come into play.

One is a **favorable pressure gradient** acting on the lee-side air in such a way as to move it away from the mountains so that the warm foehn can replace it.

A second mechanism is the **mountain wave** phenomenon. The wavelength and wave amplitude depend upon the strength of the flow bearing against the mountains and the stability of the layers in which the wave may be embedded. When these factors are favorable for producing waves which correspond to the shape of the mountain range, the foehn flow will follow the surface and produce strong surface winds on the lee slopes. There is evidence that strong downslope winds of the warm foehn on lee slopes are always caused by mountain waves. The change in wavelength and amplitude can account for the observed periodic surfacing and lifting of foehn flow. Surfacing often develops shortly after dark as cooling stabilizes the air crossing the ridge.

The Chinook, a foehn wind on the eastern slopes of the Rocky Mountains, often replaces cold continental air in Alberta and the Great Plains. Quick wintertime thawing and rapid snow evaporation are characteristic. If the cold air is held in place by the local pressure and circulation system, the foehn will override it; or if the cold air stays in the bottoms because of its greater density, the Chinook may reach the surface only in the higher spots. Relative humidities dropping to 5 percent or less and temperature changes of 30°F, to 40°F. within a few minutes are common in Chinooks.

Along the Pacific coast a weak foehn may be kept aloft by cool marine air flowing onshore. On the other hand, a strong, well-developed foehn may cut through all local influences and affect all slope and valley surfaces from the highest crest to the sea. **East winds** in the Pacific Northwest, for example, sometimes flow only part way down the lee slopes of the Cascades, and then level off above the lowlands and strike only the higher peaks and ridges of the coastal mountains. At other times virtually all areas are affected.

North and Mono winds in northern and central California develop as a High moves into the Great Basin. North winds develop if a High passes through Washington and Oregon

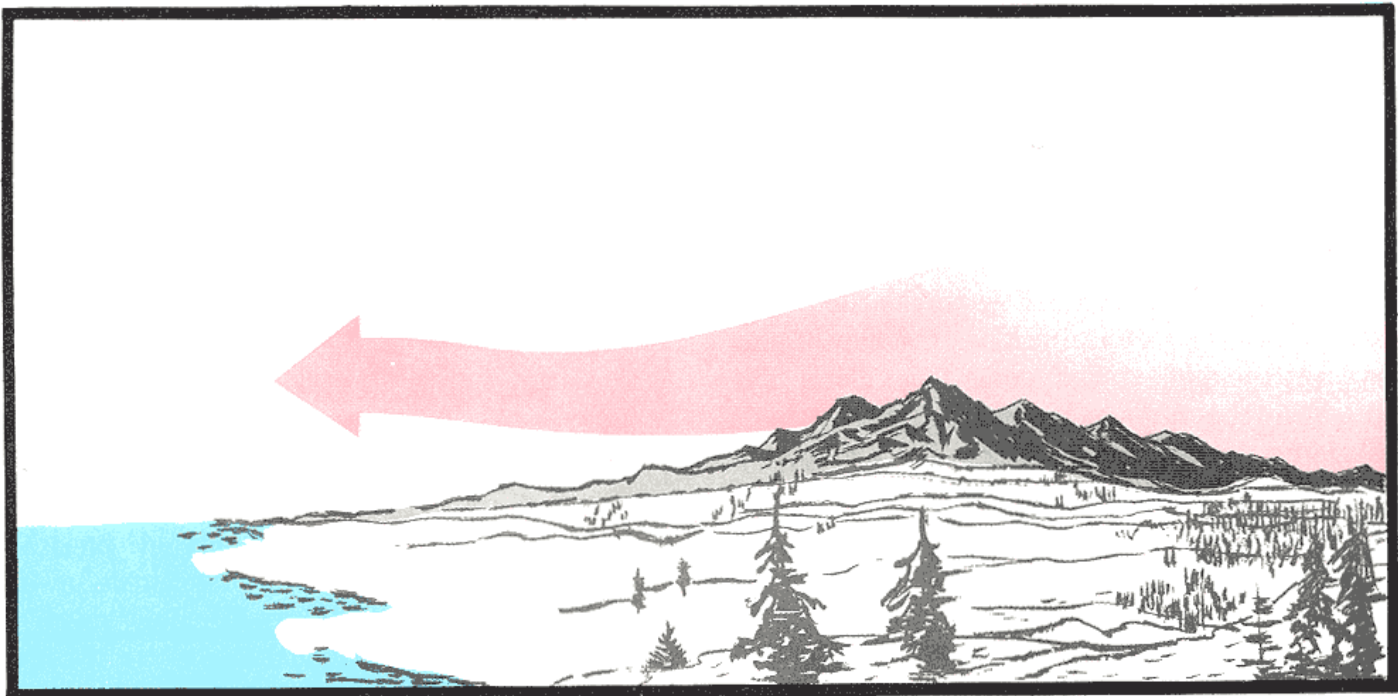

A weak foehn may override cooler air on the lee side of the mountains. In these cases only the higher elevations are affected by the foehn flow.

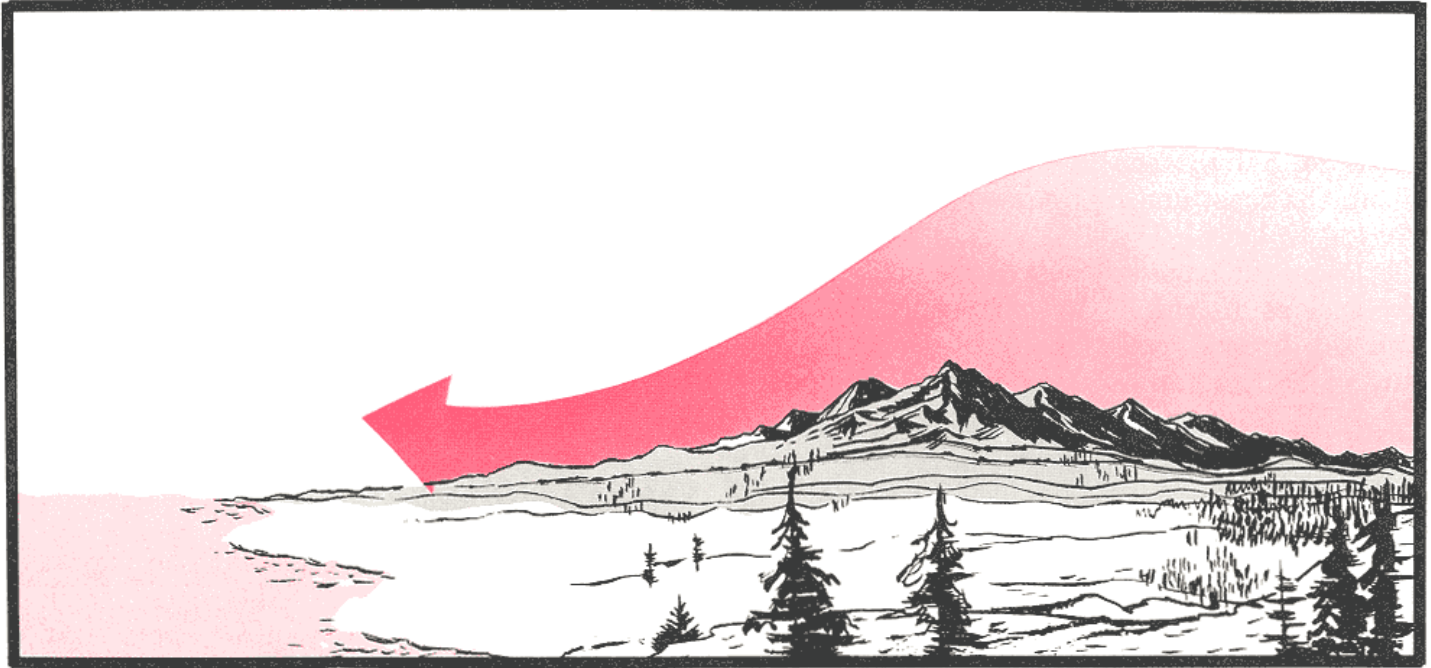

A strong foehn may flow down the leeward side of the mountains bringing warm and extremely dry air to lower elevations. The air initially to the lee of the mountains is either moved away from the mountains by a favorable pressure gradient or it is scoured out by a suitable mountain – wave shape in the foehn flow. The foehn flow may surface and return aloft alternately in some foehn wind situations.

while a trough is located in the Sacramento Valley. Mono winds occur after the High has reached the Great Basin, providing there is a trough near the coast. Both North and Mono are foehn winds bringing warm, dry air to lower elevations. At times they will affect only the western slopes of the Sierra Nevada, and at other times they push across the coastal mountains and proceed out to sea. This depends upon the location of the low-pressure trough. These winds are most common in late summer and fall.

The Santa Areas of southern California also develop with a High in the Great Basin. The low-pressure trough is located along the southern California coast, and a strong pressure gradient is found across the southern California mountains.

In the coastal mountains, and the valleys, slopes, and basins on the ocean side, the Santa Ana varies widely. It is strongly channelled by the major passes, and, at times, bands of clear air can be seen cutting through a region of limited visibility. The flow coming over the tops of the ranges may remain aloft on the lee side or drop down to the surface, depending upon whether the Santa Ana is "strong" or

"weak" and upon its mountain-wave characteristics. If the foehn flow is weak and remains aloft, only the higher elevations in the mountains are affected by the strong, dry winds. Local circulations, such as the sea breeze and slope winds, are predominant at lower elevations, particularly to areas away from the major passes.

Typically in southern California during the Santa Ana season, there is a daytime onshore breeze along the coast and gentle to weak upslope and upcanyon winds in the adjacent mountain areas. With nighttime cooling, these winds reverse in direction to produce downcanyon and offshore winds, usually of lesser magnitude than the daytime breeze. A strong Santa Ana wind wipes out these patterns. It flows over the ridges and down along the surface of leeward slopes and valleys and on to the sea. **The strong winds, along with warm temperatures and humidities sometimes lower than 5 percent, produce very serious fire weather in a region of flashy fuels.** The strong flow crossing the mountains creates mechanical turbulence, and many eddies of various sizes are produced by topographic features.

A strong Santa Ana, sweeping out the air

ahead of it, often shows little or no difference in day and night behavior in its initial stages. But, after its initial surge, the Santa Ana begins to show a diurnal behavior. During the daytime, a light sea breeze may be observed along the coast and light upvalley winds in the coastal valleys. The Santa Ana flow is held aloft, and the mountain waves are not of proper dimensions to reach the surface. The air in the sea breeze may be returning Santa Ana air, which has had only a short trajectory over

the water and is not as moist as marine air. After sunset, the surface winds reverse and become offshore and downslope. Increasing air stability may allow the shape of the mountain, waves to change so that the lower portions of waves can strike the surface and produce very strong winds down the lee slopes. As the Santa Ana continues to weaken, the local circulations become relatively stronger and finally the normal daily cycle is resumed.

EFFECTS OF VEGETATION

Vegetation is part of the friction surface which determines how the wind blows near the ground. Forests and other vegetated areas are characteristically rough surfaces and thus contribute to air turbulence, eddies, etc. They also have the distinction of being somewhat pervious, allowing some air movement through, as well as over and around, the vegetation.

Wind speeds over open, level ground, although zero at the very surface, increase quite rapidly in the first 20 feet above the ground.

Where the surface is covered with low-growing, dense vegetation such as grass or brush, it is satisfactory, for most weather purposes, to consider the effective friction surface as the average height of the vegetation, disregarding the air flowing through it. In areas forested with trees, however, airflow within and below the tree canopies is important.

The leaf canopy in a forest is very effective in **slowing down** wind movements because of its large friction area. In forests of shade-tolerant

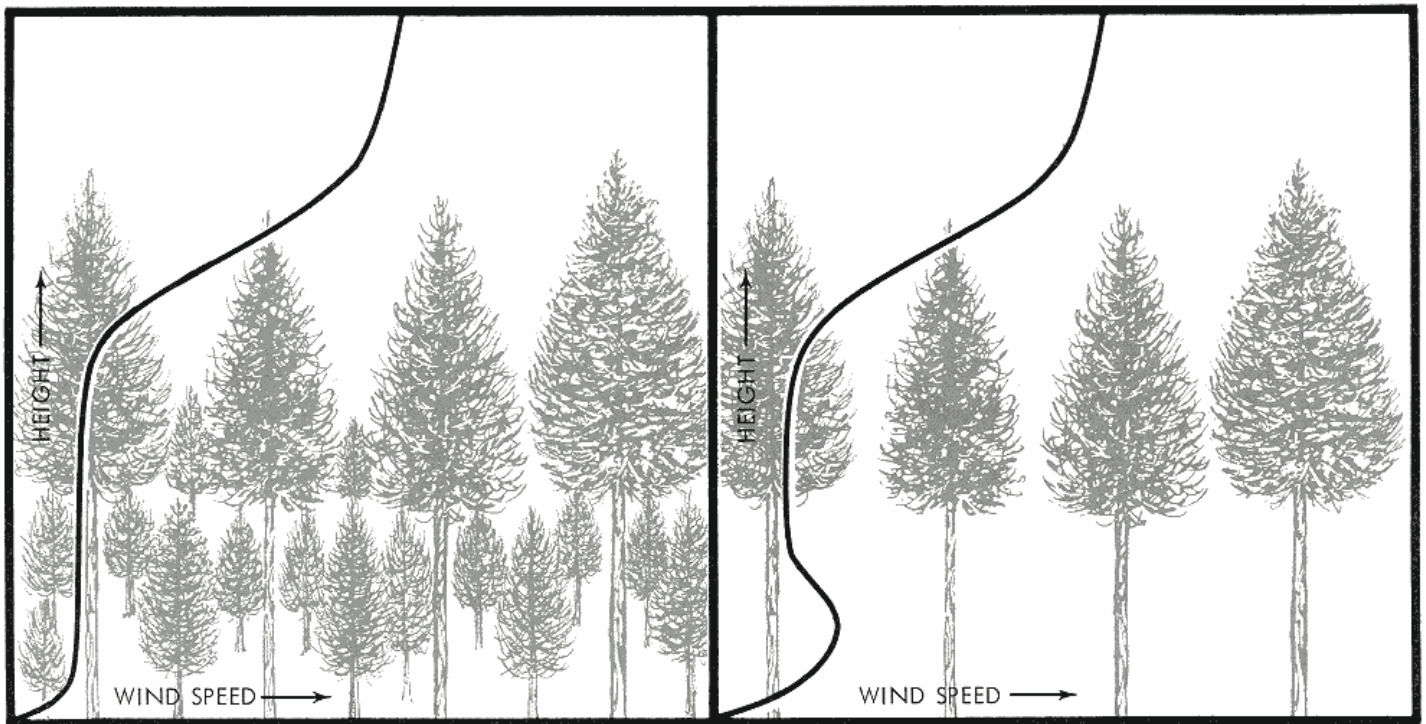

Vertical wind profiles in forest stands that the crown canopy is very effective in slowing down wind movement. In stands with an understory, the wind speed is nearly constant from just above the surface to near the tops of the crowns. Above the crowns, wind speed increases much like above level ground. In stands with an open trunk space, a maximum in wind speed is likely in the trunk space and a minimum in the crown area.

species where the canopy extends to near ground level, or in stands with understory vegetation, wind speed is nearly constant from just above the surface to near the tops of the crowns. Above the crowns, wind speed increases much as it does over level ground. In forest stands that are open beneath the main tree canopy, air speed increases with height above the surface to the middle of the trunk space, and then decreases again in the canopy zone,

How much the wind speed is reduced inside the forest depends on the detailed structure of the forest stand and on wind speed above the forest canopy, or as measured out in the open away from the forest. The drag of any friction surface is relatively much greater at high wind speeds than it is with low speeds. At low wind speeds, the forest may have only a small effect on the speed of the wind. For example, a 4-m.p.h. wind measured in the open might be slowed to 2.5-m.p.h. at the same height inside the forest. But a fairly high wind speed in the open will be slowed in the forest in much greater proportion. Thus, a 20-m.p.h. wind might be reduced to 4 - or 5 - m.p.h. in an 80-foot-tall stand of second-growth pine with normal stocking. The reduction would vary considerably, however, among different species and types of forest. Deciduous forests have a further seasonal variation, because although trees bare of leaves have a significant effect in limiting surface wind speeds, it is far less than when the trees are in full leaf.

Local eddies are common in forest stands and are found in the lee of each tree stem. These small eddies affect the behavior of surface fires.

Larger scale eddies often form in forest openings. The higher winds aloft cause the slower moving air in these openings to rotate about a vertical axis, or roll over in a horizontal manner. The surface wind direction is then frequently opposite to the direction above the treetops.

The edges of tree stands often cause roll eddies to form in the same manner as those

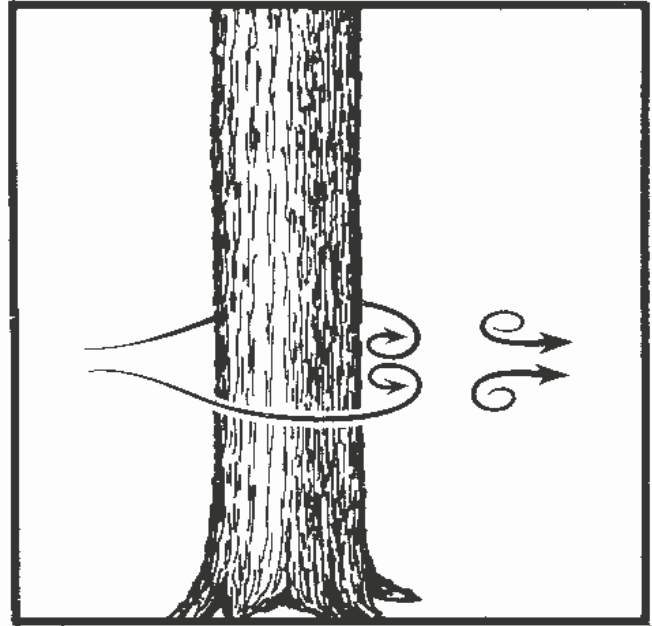

Local eddies form in the lee of each tree stem and affect the behavior of surface fires.

associated with bluffs. Wind blowing against the stand often produces small transient eddies on the windward side, while those in the lee of a forest are mostly larger and more fixed in location, with subeddies breaking off and moving downwind.

Strong surface heating, as on warm, sunny days, adds to the complexity of these forest airflow patterns. Thermal turbulence is added to the generally turbulent flow through open timber stands as it is to the flow above a closed forest canopy. The flow beneath a dense canopy is affected only slightly by thermal turbulence, except where holes let the sun strike bare ground or litter on the forest floor. These become hotspots over which there is a general upwelling of warm air through the canopy. This rising air is replaced by gentle inflow from surrounding shaded areas. Thermal turbulence on the lee side of a forest stand may often be enough to disguise or break up any roll eddies that tend to form.

SUMMARY

In this chapter we have discussed winds which are related to the large pressure patterns observed on synoptic-scale weather maps. We have seen

that these general winds are strongly affected by the type of surface over which they flow, and that the amount of influence is largely

dependent on the wind speed and the stability of the air. Stable air flowing over even surfaces tends to be smooth, or laminar. Unstable air or strong winds flowing over rough surfaces is turbulent and full of eddies.

Surface winds in the Northern Hemisphere tend to shift clockwise with the passage of fronts. In mountainous topography, however, the effect of the mountains on the windflow usually overshadows this. The windflow is channelled, and, over sharp crests, eddies are produced. At times, waves form over mountains, and, if conditions are favorable, strong

surface winds are experienced on the lee side. When the airflow is from higher to lower elevations, the air warms adiabatically and foehn winds are produced. These winds have local names, such as Chinook, Santa Ana, etc., and are the cause of very severe fire weather.

In the next chapter we will consider local winds which result from local heating and cooling. They are called **convective winds**, and include such wind systems as mountain and valley winds, land and sea breezes, whirlwinds, and thunderstorm winds.

Chapter 7

CONVECTIVE WINDS

Winds of local origin—convective winds caused by local temperature differences—can be as important in fire behavior as the winds produced by the synoptic-scale pressure pattern. In many areas they are the predominant winds in that they overshadow the general winds. If their interactions are understood, and their patterns known, the changes in behavior of wildfires can be predicted with reasonable accuracy. Fires occurring along a coastline will react to the changes in the land and sea breezes. Those burning in mountain valleys will be influenced by the locally produced valley and slope winds. Certainly there will be times when the convective winds will be severely altered or completely obliterated by a strong general wind flow. These cases, in which the influences of the general winds on fire behavior will predominate, must be recognized.

Convective Winds

In the absence of strong synoptic-scale pressure gradients, local circulation in the atmosphere is often dominated by winds resulting from small-scale pressure gradients produced by temperature differences within the locality. Air made buoyant by warming at the surface is forced aloft; air which is cooled tends to sink. Buoyant air is caused to rise by horizontal airflow resulting from the temperature-induced small-scale pressure gradients.

In different convective circulation systems, either the vertical or the horizontal flow may be the more important but both are part of the same system. Hence, convective winds here refer to all winds—up, down, or horizontal—that have their principal origin in local temperature differences. This is somewhat different from common meteorological usage, wherein convection implies upward motion only.

Convective winds may be augmented, opposed, or eliminated by airflow having its origin in the larger pressure systems. The influence of these general winds on the convective wind systems varies with the strength of the general wind, its direction relative to the convective circulation, and the stability of the lower atmosphere.

The nature and strength of convective winds vary with many other factors. Since they are temperature-dependent, all features of the environment that affect heating and cooling are significant. Among the more important are season, diurnal changes, cloud cover, nature of the terrain and its cover such as water, vegetation, or bare ground, and the moisture and temperature structure of the overlying atmosphere.

The strong temperature dependence of convective winds make local temperature observations useful indicators of probable wind behavior. Simultaneous measurements may show significant horizontal temperature gradients. In the absence of upper-air soundings,

mountaintop and valley-bottom readings give fair approximations of the temperature lapse rate and associated stability or instability. Height of the nighttime inversion may usually be located in mountain valleys by traversing side slopes and by taking thermometer readings.

Strong surface heating produces the most varied and complex convective wind systems. Warmed air adjacent to heated slopes tends to be forced upslope to the crest where it flows off in a more-or-less continuous stream. These convective currents frequently cause daytime cumulus clouds so often observed over mountain peaks and ridges. In generally flat terrain, air heated at the surface tends to remain in stagnant layers because of inertia, until it reaches a critical point of instability or is released by mechanical triggering. The escaping air usually takes the form of intermittent bubbles that break free and are forced aloft by surrounding denser air. As they ascend, the bubbles grow by expansion and by mixing with surrounding air. These, too, may form cumulus clouds. Superheated air may escape also in the form of upward-spiraling whirlwinds or dust devils. These vortexes draw on new supplies of heated air as they move along the surface.

Air that is cooled near the surface almost invariably flows downward along the steepest route available, seeking the lowest levels. En-route, if it should meet colder air beneath it, the downflowing air spreads out on top of the colder layer.

Other types of local convective circulations involving both vertical and horizontal movement occur where there are differences in heating between sizeable adjacent areas. Most familiar among these are the land and sea breezes found along ocean shores and around the larger inland lakes and bays.

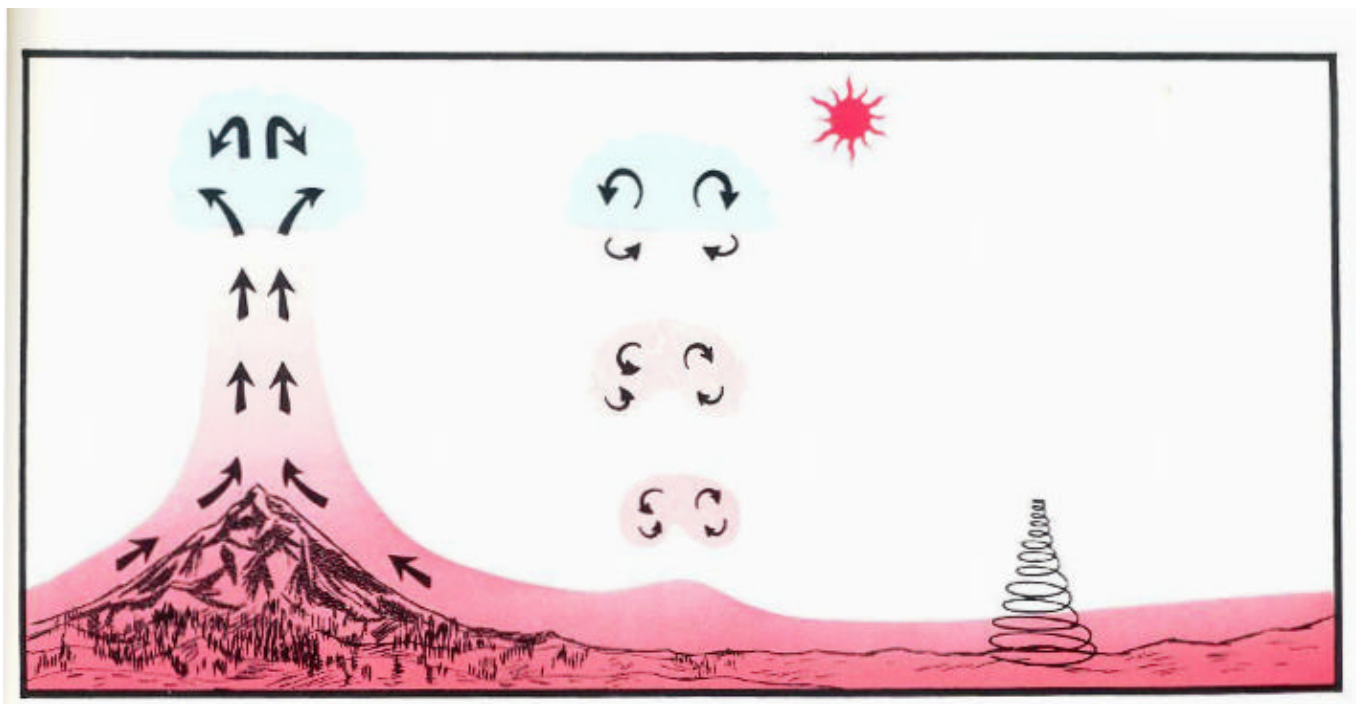

Strong surface heating produces several kinds of convective systems. Upslope winds develop along heated slopes. Superheated air in flat terrain escapes upward in bubbles or in the form of whirlwinds or dust devils.

LAND AND SEA BREEZES

During the daytime, when land surfaces become warmer than adjacent water surfaces, the air over the land expands, becomes less dense, and the pressure becomes lower than that over the nearby water. In chapter 2 we considered in some detail the several reasons why land surfaces become warmer than water surfaces during the daytime. As a result of this local-scale pressure difference, a sea **breeze begins** to flow inland from over the water, forcing the warm air over the land to rise and cool adiabatically. In the absence of strong general winds, this air flows seaward aloft to replace air which has settled and moved toward shore, and thus completes the circulation cell.

The surface sea breeze begins around mid-forenoon, strengthens during the day, and ends around sunset, although the times can vary of local considerably because conditions of cloudiness and the general winds. The breeze begins at the coast, then gradually pushes farther and farther inland during the day, reaching its maximum penetration about the time of maximum temperature.

The **land breeze** at night is the reverse of the daytime sea-breeze circulation. At night, land surfaces cool more quickly than water surfaces

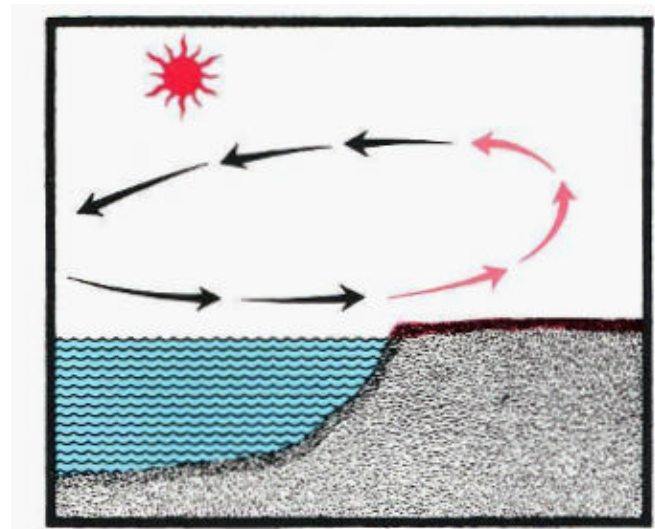

As land surfaces become warmer than adjacent water surfaces during the daytime, and air over the land becomes warm and buoyant, the denser sea breeze begins to flow inland from over the water and forces the less-dense air upward.

(discussed in chapter 2). Air in contact with the land then becomes cooler than air over adjacent water. The increase in air density causes pressure to become relatively higher over the land than over the water, and this pressure difference, in turn, causes air to flow from the land to the water. The air must be replaced, but any return flow aloft is likely to be so weak and diffuse that it is lost in the prevailing general winds.

The land breeze begins 2 to 3 hours after sunset and ends shortly after sunrise. It is a more gentle flow than the sea breeze, usually about 3 to 5 miles per hour. The land air, having been cooled from below by contact with the ground, is stable. The land breeze is, therefore, more laminar and shallower than the sea breeze.

The daily land and sea breezes tend to occur quite regularly when there is no significant influence from the general wind flow. When general winds are sufficiently strong, however, they usually mask the land and sea breezes. A general wind blowing toward the sea opposes the sea breeze and, if strong enough, may prevent its development. In any case the sea breeze is delayed. Depending on the strength of the general wind, this delay may extend into the afternoon. This often results in a “piling up” of marine air off the coast. Then, when the local pressure difference becomes great

enough, this sea air moves in-land with the characteristics of a small-scale cold front. Air behind the front is initially cool and moist but warms rapidly as it moves over sun-warmed land.

The land breeze does not form against a strong onshore general wind. It is common, however, for the land breeze to slide under onshore winds of light speeds. In doing so, the land breeze does not extend very far seaward.

General winds, either in the direction of the land or sea breeze, or parallel to the coast,

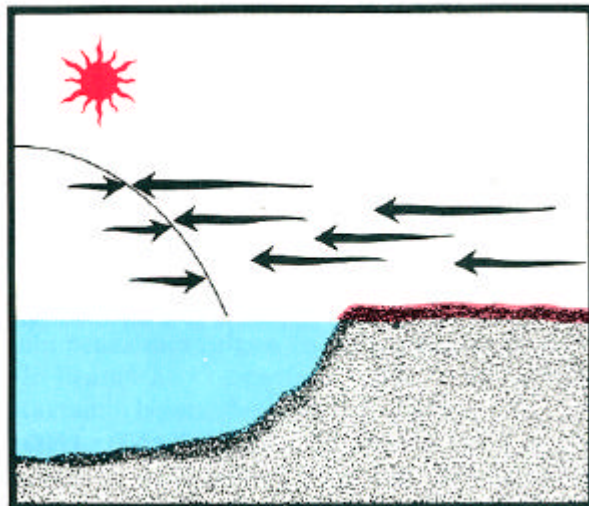

A general wind blowing toward the sea operates against the sea breeze and, if strong enough, may block the sea breeze entirely.

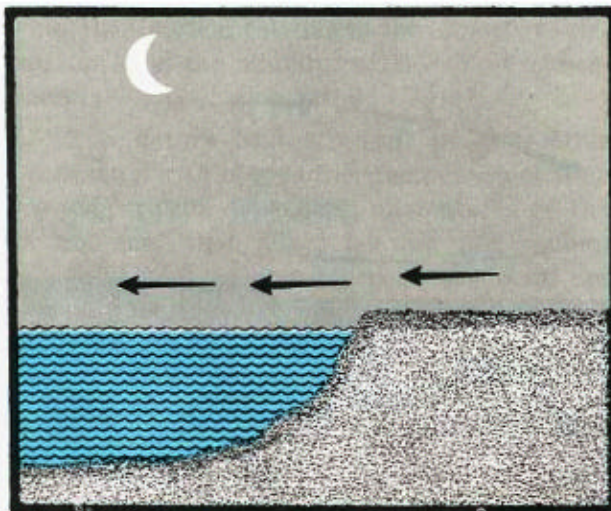

At night, land surfaces cool more quickly than water surfaces. Air in contact with the land becomes cool and flows out over the water as a land breeze, displacing the warmer air.

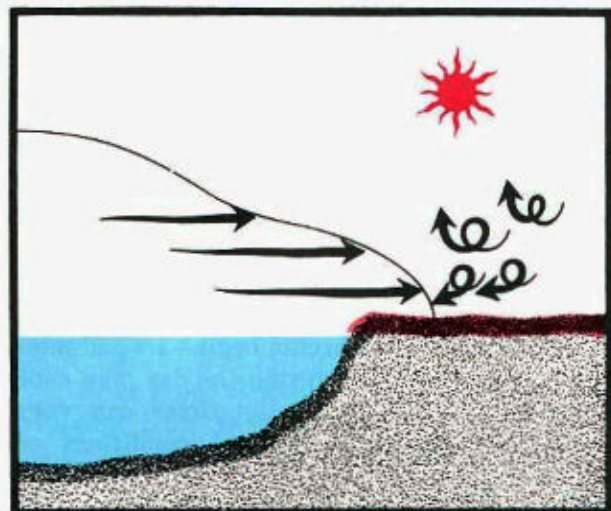

If marine air has been piled up over the water by an offshore wind, it may rush inland like a small-scale cold front when the local pressure difference becomes great enough.

tend to mask the true land- or sea-breeze component. Strong general winds produce mechanical mixing which tends to lessen the temperature difference between the land and the sea surfaces. Thus the sea-breeze component becomes weak and only slightly alters the general wind flow. General winds also tend to mask out the closed-cell feature of the land- and sea-breeze circulations by overshadowing the return flow aloft. With an onshore general wind aloft, for example, there is no return flow in the daytime sea-breeze circulation.

General winds along an irregular or crooked coastline may oppose a land or sea breeze in one sector and support it in another. Oftentimes, too, shifting general winds may cause periodic reversals of these effects in nearby localities, and may result in highly variable local wind patterns.

Land and sea breezes occur along much of the Pacific coast, the Gulf of Mexico, and the Atlantic seaboard. Eastern and western land and sea breezes differ in their respective behaviors due to marked differences in general circulation patterns, temperature contrasts, and topography. Whether or not these factors are significant locally depends on the local climate



General winds along an irregular or crooked coastline may oppose a sea breeze in one sector and not in another.

and on the shape and orientation of the shoreline and inland topography.

Gulf and Atlantic Breezes

In the East, land and sea breezes are most pronounced in late spring and early summer, when land and water temperature differences are greatest, and they taper off toward the end of the warm season as temperature differences decrease. They are sufficiently strong during the spring and fall fire seasons to warrant consideration as important fire-weather elements in coastal areas.

Land- and sea-breeze circulations in the East are more often dominated by changes in the general wind pattern than they are in the West. Otherwise, the eastern land and sea breeze represents a more simple situation than the western because coastal topography is flat and uniform.

During the fire season in the East, general circulation patterns are such that on both the Gulf and Atlantic shores there are frequent periods of onshore or offshore winds strong enough to block or mask out land- and sea-breeze development. Onshore general winds almost always mask sea-breeze effects. During periods of gentle to moderate offshore winds, on the other hand, the sea breeze may develop and move inland. Against an opposing general wind, however, the sea breeze moves forward behind a small-scale cold front. This moves slowly, perhaps 3 or 4 miles an hour, and at times may oscillate back and forth with the varying force of the general wind. In addition to the rapid changes in wind speed and direction associated with a cold-front passage, a small area may thus be subjected to several of these passages over a considerable time. At this slow and intermittent pace, the sea breeze may have penetrated inland only a few miles by late afternoon.

Another feature of this type of sea breeze is that it is operating in an area of convergence. This is conducive to turbulent vertical motion in addition to the above-mentioned horizontal surface disturbances. **This combination can create critical fire-weather situations**, particularly in view of the fact that this type of sea breeze is prone to occur on high fire-danger days.

The reverse land breeze often becomes just part of the offshore general wind and thereby loses its identity.

Pacific Coast Sea Breeze

The Pacific coastal area sea breeze is at its peak at the height of the summer fire season. It is an important feature of the summer weather along much of the Pacific coast. Water temperatures there are much lower than along the Gulf of Mexico and the Atlantic coast. Intense daytime land heating under clear skies is an additional factor in producing greater land-water temperature differences along the Pacific coast. The sea breeze is, therefore, stronger along the western than the eastern coasts. It is a daily summertime occurrence along the Pacific coast except on rare occasions when it is opposed by the general circulation.

Normally the general wind serves to strengthen the Pacific coast sea breeze. During the summer months, the semipermanent North Pacific High is located in the general area between Hawaii and Alaska. Flow from this high to the California Low results in onshore surface winds along most of the Pacific coast. This seasonal flow, called the Pacific coast monsoon, begins in spring and lasts until fall. The sea breeze is superimposed on the monsoon circulation. During the day, air from the ocean moves inland, rises as it is heated, mixes with the upper winds, and is replaced on the seaward side by gradually settling air from the general circulation.

Since the monsoon flows onshore both day and night, it tends to weaken, or reduce to a negligible amount, the night land breeze. However, this opposition of forces also slows down the onshore monsoon at night. During the day, the sea breeze, assisted by the monsoon, brings in a fresh surge of marine air. Because of this assistance, the marine layer is thicker, and moves farther inland, than does the sea breeze in the East.

The Pacific sea breeze brings relatively cool, moist marine air to the coastal areas. The passage of the leading edge of this air—the sea-breeze front—is marked by a wind shift and an increase in wind speed. Often it is accompanied by fog or low stratus clouds, particularly in the morning hours. Within the first few

miles inland, however, the marine air is subjected to heating as it passes over the warmer land. If the marine-air layer is shallower than normal, this air may soon become almost as warm as the air it is replacing. The strong temperature contrasts then remain near the coast while the warmed sea breeze may penetrate many miles beyond.

Thus the effect of the sea breeze on fire behavior can vary considerably. Where the marine air is not modified appreciably, its lower temperatures and higher humidities produce less dangerous fire weather. Where the marine air is modified extensively by heating, the temperature and humidity changes with the sea-breeze front become negligible, while the shifting wind direction and increase in wind speed and gustiness can be a serious detriment to fire control.

Because of surface friction, the sea breeze often moves inland more rapidly at the top of the marine layer than at the surface. Instability and convective mixing caused by surface warming then tend to bring the sea breeze aloft down to the surface, so that the sea-breeze front appears to progress on the surface in jumps or surges. The motion is somewhat analogous to that of the forward portions of the endless metal tracks on a moving tractor.

The Pacific sea breeze is characterized by considerable thermal turbulence and may extend inland 30 to 40 miles or more from the water under favorable conditions. The depth of the sea breeze is usually around 1,200 to 1,500 feet, but sometimes reaches 3,000 feet or more. Its intensity will vary with the water-land temperature contrast, but usually its speed is around 10 to 15 miles per hour.

Mountains along the Pacific coastline act as barriers to the free flow of surface air between the water and the land. On seaward-facing slopes the sea breeze may combine with upslope winds during the daytime, thus transporting modified marine air to the higher elevations in the coastal mountains.

River systems and other deep passes that penetrate the coast ranges provide the principal inland sea-breeze flow routes. The flow of cool, moist air is sufficient to carry tremendous amounts of marine air inland, helping to maintain inland summer humidities at moderate levels in the areas opposite the passes. Here, the

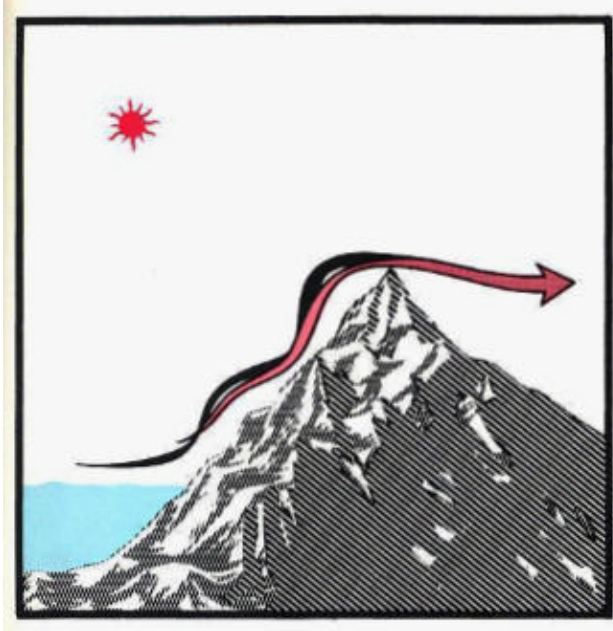

Mountains along the coastline act as barriers to the free flow of air between the water and the land. On seaward-facing slopes, the sea breeze may combine with upslope winds during the daytime and bring modified marine air to higher elevations.

sea breeze joins with afternoon upvalley and upcanyon winds, resulting in a cooler, relatively strong flow. In broad valleys, this flow takes on the usual sea-breeze characteristics, but in narrow canyons and gorges it may be strong and very gusty as a result of both mechanical and thermal turbulence.

The coastal mountains similarly cut off major flow from the land to the sea at night. Downslope winds on the ocean-facing slopes join with a feeble land breeze from the coastal strip at night, but again, the outflowing river systems provide the principal flow routes. The

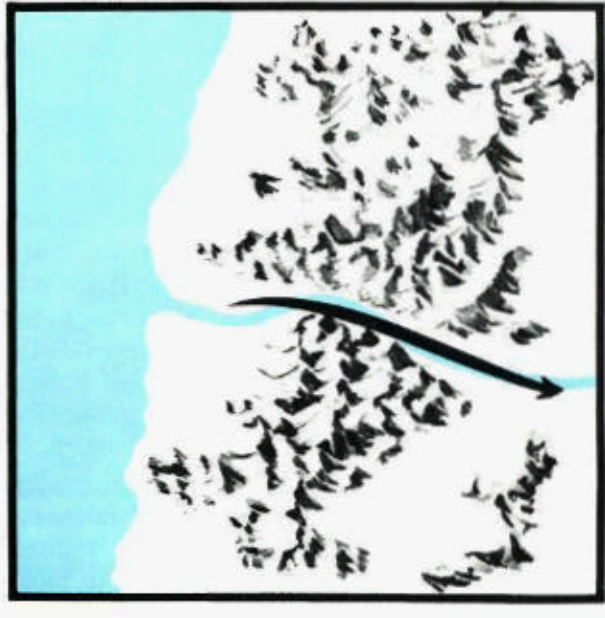

River systems and other deep passes that cut through coast ranges provide the principal sea-breeze flow routes.

downvalley and downcanyon flow is, like the normal land breeze, a relatively shallow and low-speed wind system.

Small-scale diurnal circulations similar in principle to land and sea breezes occur along the shores of inland waters. Lake breezes can appear along the shores of lakes or other bodies of water large enough to establish a sufficient air temperature gradient. The lake breeze is common in summer, for example, along the shores of the Great Lakes. On a summer afternoon it is not unusual for most shore stations to experience onshore winds.

SLOPE AND VALLEY WINDS

Winds in mountain topography are extremely complex. Part of the time, the general winds associated with larger scale pressure systems dominate the surface layer. But when larger scale pressure systems weaken, the general winds lessen. Then, in the presence of strong daytime heating or nighttime cooling, convective winds of local origin become important features of mountain weather. These conditions are typical of clear summer weather in

which there is a large diurnal range of surface air temperatures.

General and convective winds may displace, reinforce, or oppose each other. Their relationship to each other can change quickly—often with surprising rapidity. Variations between different terrain features—sometimes separated only by yards—are often noted. The convective activity may dominate the observed surface wind in one instance, and in another it

may permit the speed and direction of winds aloft to dominate the surface flow through the mixing process.

The interactions between airflow of different origins, local pressure gradients caused by nonuniform heating of mountain slopes, and the exceedingly complex physical shapes of mountain systems combine to prevent the rigid application of rules of thumb to convective winds in mountain areas. Every local situation must be interpreted in terms of its unique qualities. Wind behavior described in this section is considered typical, but it is subject to interruption or change at virtually any time or place.

Differences in air heating over mountain slopes, canyon bottoms, valleys, and adjacent plains result in several different but related wind systems. These systems combine in most instances and operate together. Their common denominator is upvalley, upcanyon, upslope flow in the daytime and downflow at night. They result from horizontal pressure differences, local changes in stability that aid vertical motion, or from a combination of the two.

Slope Winds

Slope winds are local diurnal winds present on all sloping surfaces. They flow upslope during the day as the result of surface heating, and downslope at night because of surface cooling. Slope winds are produced by the local pressure gradient caused by the difference in temperature between air near the slope and air at the same elevation away from the slope.

During the daytime the warm air sheath next to the slope serves as a natural chimney and provides a path of least resistance for the upward flow of warm air. Ravines or draws facing the sun are particularly effective chimneys because of the large area of heated surface and steeper slopes; winds are frequently stronger here than on intervening spur ridges or uniform slopes. Upslope winds are quite shallow, but their depth increases from the lower portion of the slope to the upper portion. Turbulence and depth of the unstable layer increase to the crest of the slope, which is the main exit for the warm air. Here, momentum of the upflowing air, convergence of upslope winds from opposite slopes, and mechanical turbulence combine to make the ridge a very turbulent region where much of the warm air escapes aloft.

The crests of higher ridges are also likely to experience the influence of the general wind flow, if that flow is moderate or strong.

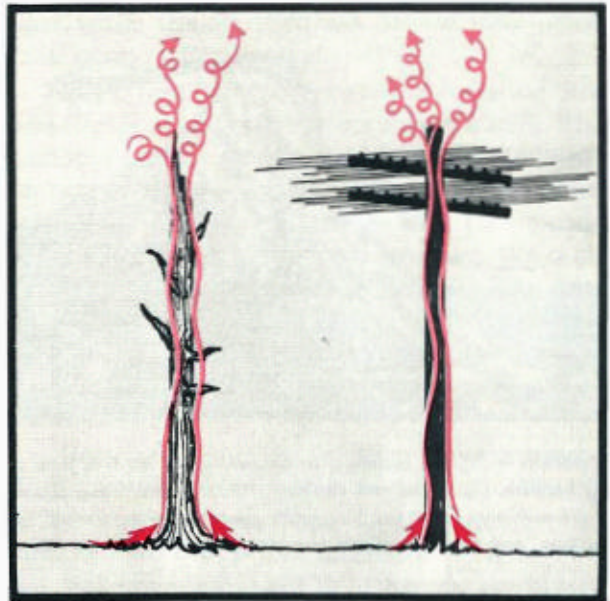

Air heated by contact with vertical or sloping surfaces is forced upward and establishes natural chimneys through which warm air flows up from the surface.

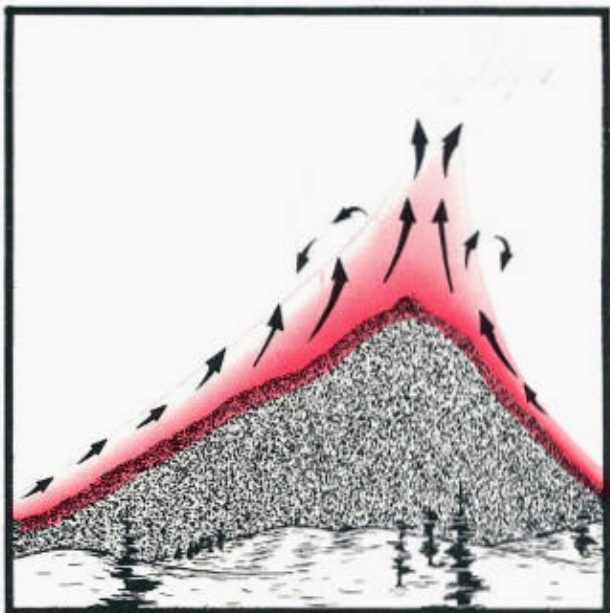

Upslope winds are shallow near the base of slopes but increase in depth and speed as more heated air is funneled along the slope. Warm air bubbles forced upward cause turbulence which increases the depth of the warmed layer.

At night the cool air near the surface flows downslope much like water, following the natural drainage ways in the topography. The transition from upslope to downslope wind begins soon after the first slopes go into afternoon shadow and cooling of the surface begins. In individual draws and on slopes going into shadow, the transition period consists of (1) dying of the upslope wind, (2) a period of relative calm, and then (3) gentle laminar flow downslope.

Downslope winds are very shallow and of a slower speed than upslope winds. The cooled denser air is stable and the downslope flow, therefore, tends to be laminar.

Downslope winds may be dammed temporarily where there are obstructions to free flow, such as crooked canyons and dense brush or timber. Cool air from slopes accumulates in low spots and overflows them when they are full. The principal force here is gravity. With weak to moderate temperature contrasts, the airflow tends to follow the steepest downward routes through the topography. Strong air temperature contrasts result in relatively higher air speeds. With sufficient momentum, the air tends to flow in a



Downslope winds are shallow, and the flow tends to be laminar. The cold air may be dammed by obstructions such as dense brush or timber.

straight path over minor topographic obstructions rather than to separate and flow around them on its downward course.

Cool, dense air accumulates in the bottom of canyons and valleys, creating an inversion which increases in depth and strength during the night hours. Downslope winds from above

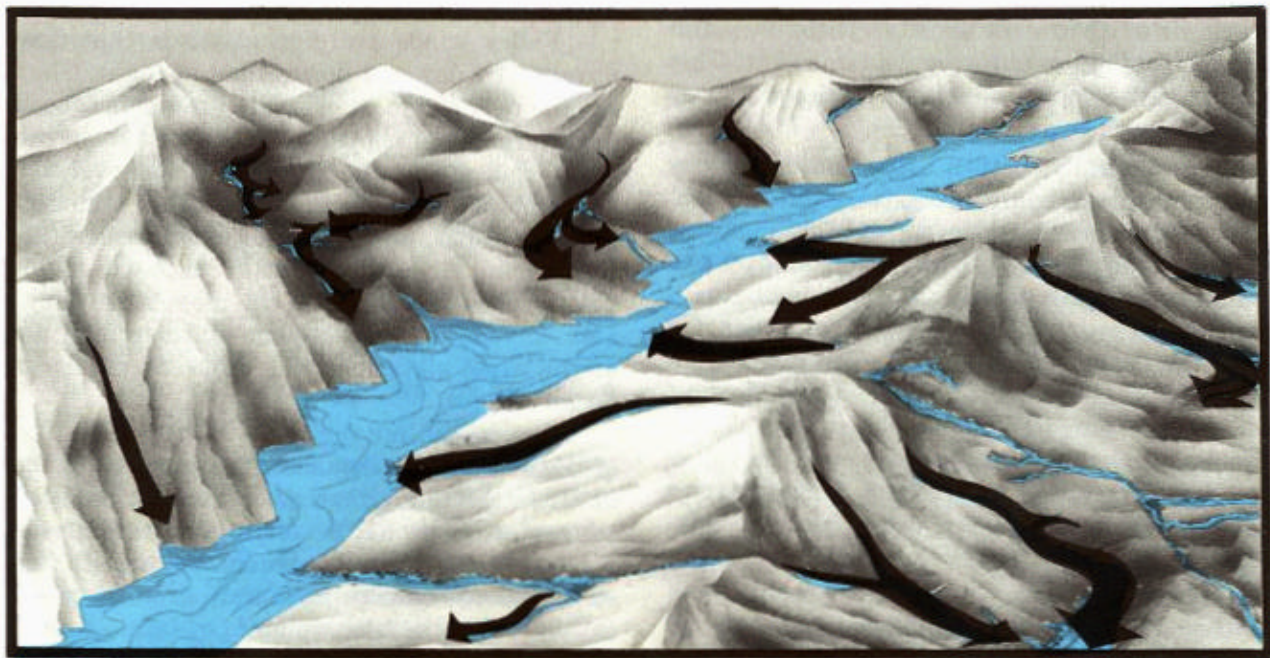

At night, the cool denser air near the surface of slopes flows downward, much like water, following the natural drainage ways in the topography. The principal force is gravity.



Cool, dense air settles in the bottom of canyons and valleys, creating an inversion which increases in depth and strength during the night hours. Cool air flows outward over the valley bottom when it reaches air of its own density.

the inversion continue downward until they reach air of their own density. There they fan out horizontally over the canyon or valley. This may be either near the top of the inversion or some distance below the top.

Theoretically, both upslope and downslope winds may result in a cross-valley circulation. Air cooled along the slopes at night flows downward and may be replaced by air from over the valley bottom. Air flowing upslope in the daytime may be replaced by settling cooler air over the center of the valley. The circulation system may be completed if the upward flowing air, on reaching the upper slopes, has cooled enough adiabatically to flow out over the valley and replace air that has settled. During strong daytime heating, however, cross-valley circulation may be absent. Upflowing air is continually warmed along the slopes. Adiabatic cooling may not be sufficient to offset the warming, and the warmer air is forced aloft above the ridgetops by denser surface air brought in by the upvalley winds.

Valley Winds

Valley winds are diurnal winds that flow **upvalley** by day and **downvalley** at night. They are the result of local pressure gradients caused by differences in temperature between air in the valley and air at the same elevation over the adjacent plain or larger valley. This temperature difference, and the resulting pressure difference and airflow, reverses from day to night. During the day, the air in the mountain valleys and canyons tends to become warmer than air at the same elevation over adjacent plains or larger valleys.

One reason for the more intensive heating of the mountain valley air is the smaller volume of air in the valley than over the same horizontal surface area of the plain. The rest of the volume is taken up by landmass beneath the slopes. A valley may have only from one-half to three-fourths the volume of air as that above the same horizontal surface area of the plain.

Another reason is the fact that the mountain

valley air is somewhat protected by the surrounding ridges from the general wind flow. The valley air is heated by contact with the slopes, and the resulting slope-wind circulation is effective in distributing the heat through the entire mass of valley air. As the valley air becomes warmer and less dense than the air over the plain, a local pressure gradient is established from the plain to the valley, and an upvalley wind begins.

Whereas upslope winds begin within minutes after the sun strikes the slope, the up-valley wind does not start until the whole mass of air within the valley becomes warmed. Usually this is middle or late forenoon, depending largely on the size of the valley. The upvalley wind reaches its maximum speed in early afternoon and continues into the evening. Upvalley wind speeds in larger valleys are ordinarily from 10 to 15 m.p.h. The depth of the upvalley wind over the center of the valley is usually about the same as the average ridge height.

Strong upvalley and upcanyon winds may be quite turbulent because of the unstable air and the roughness of the terrain. Eddies may form at canyon bends and at tributary junctions. Along upper ridges particularly, the flow tends to be quite erratic. Wind speed and direction may change quickly, thus drastically affecting fire behavior.

Slopes along the valley sides begin to cool in late afternoon and, shortly after they come into shadow, cool air starts flowing downslope. Cool air accumulates in the valley bottom as more air from above comes in contact with the slopes and is cooled. Pressure builds up in the valley, causing the upvalley wind to cease. With continued cooling, the surface pressure within the valley becomes higher than the pressure at the same elevation over the plain, and a downvalley flow begins.

The transition from upvalley to downvalley flow takes place in the early night—the time depending on the size of the valley or canyon and on factors favoring cooling and the establishment of a temperature differential. The transition takes place gradually. First, a down-slope wind develops along the valley floor, deepens during the early

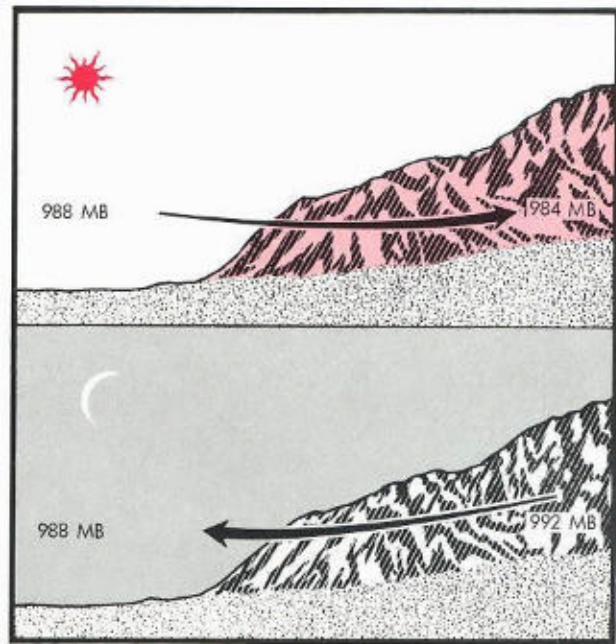

Upvalley and downvalley winds are the result of local pressure gradients caused by differences in temperature between air in the valley and air at the same elevation over the adjacent plain. The flow reverses from day to night.

night, and becomes the downvalley wind. The downvalley wind may be thought of as the exodus or release of the dense air pool created by cooling along the slopes. It is somewhat shallower than the up-valley wind, with little or no turbulence because of the stable temperature structure of the air. Its speed is ordinarily somewhat less than the upvalley wind, but there are exceptions in which the downvalley wind may be quite strong.

The downvalley wind continues through the night and diminishes after sunrise.

Valley winds and slope winds are not independent. A sloping valley or canyon bottom also has slope winds along its length, although these winds may not be easy to distinguish from valley winds. Proceeding upstream during the daytime, the combined flow continually divides at each tributary inlet into many up-ravine and upslope components to the ridge-tops. As the valley-wind system strengthens during the day, the direction of the upslope wind is affected. The first movement in the morning is directly up the slopes and minor draws to the ridgetop. Then, as the speed of the valley wind picks up, the upslope winds are changed to a more upvalley direction. By the



Th. combined upslope and upvalley winds proceed upstream during the day and continually divide at each tributary into many upvaline and upslope components.

time the valley wind reaches its maximum, the slope winds, on the lower slopes at least, may be completely dominated by the upvalley wind. Along the upper slopes, the direction may continue to be upslope, because the upvalley wind does not always completely fill the valley.

Nighttime downslope winds are similarly affected. When the downvalley wind is fully developed, it dominates the flow along the slopes, particularly the lower portion, so that the observed wind direction is downvalley.

Effects of Orientation and Vegetation

Orientation of the topography is an important factor governing slope- and valley-wind strength and diurnal timing. Upslope winds begin as a gentle upflow soon after the sun strikes the slope. Therefore, they begin first on east-facing slopes after daybreak and increase in both intensity and extent as daytime heating continues. South and southwest slopes heat the most and have the strongest upslope winds. South slopes reach their maximum wind speeds soon after midday, and west slopes by about midafternoon. Upslope wind speeds on south slopes may be several times greater than those on the opposite north slopes.



Morning upslope winds flow straight up the slopes and minor draws to the ridgetops.

Where slopes with different aspects drain into a common basin, some slopes go into shadow before others and also before the upvalley wind ceases. In many upland basins, the late afternoon upvalley winds are bent in the direction of the first downslope flow. They continue to shift as the downslope flow strengthens and additional slopes become shaded, until a 180-degree change in direction has taken place some time after sunset.

The vegetative cover on slopes will also affect slope winds and, in turn, valley winds. Bare slopes and grassy slopes will heat up more readily than slopes covered with brush or trees. Upslope winds will therefore be lighter on the brush- or tree-covered slopes. In fact, on densely forested slopes the upslope wind may move above the treetops, while at the surface



As the upvalley wind picks up during the day, the upslope winds are turned to a more upvalley direction.

there may be a very shallow downslope flow because of the shade provided by the canopy.

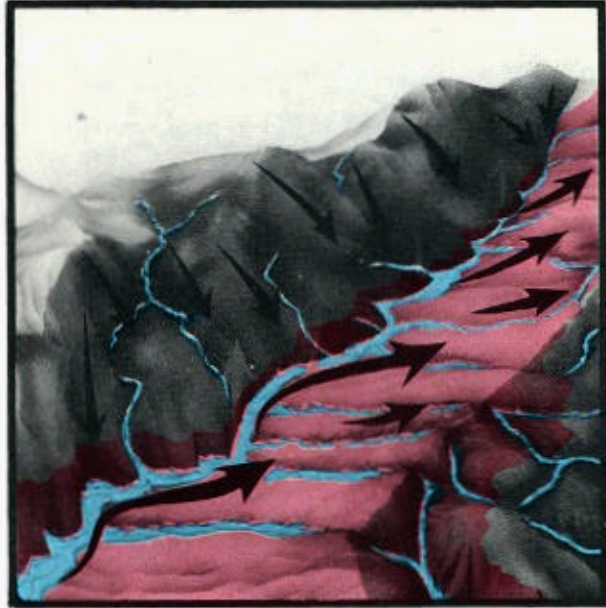

Downslope winds begin as soon as slopes go into shadow. Late afternoon upvalley winds are turned in the direction of the first downslope flow.

Downslope winds at night on densely forested slopes are affected by the presence or absence of a dense understory. Where there is an open space between the tree canopy and the surface, the downslope flow will be confined to the trunk region while calm prevails in the canopy region. A forest with a dense understory is an effective barrier to downslope winds. Here, the flow is diverted around dense areas, or confined to stream channels, roadways, or other openings cut through the forest.

INTERACTION OF VALLEY AND SLOPE WINDS WITH GENERAL WINDS

Slope and valley wind systems are subject to interruption or modification at any time by the general winds or by larger scale convective wind systems.

Midday upslope winds in mountain topography tend to force weak general winds aloft above the ridgetop. The general wind flow goes

over the rising currents above the ridge. These rising currents may be effective in producing or modifying waves in the general wind flow. Frequently, the daytime upper winds are felt only on the highest peaks. In this situation, the surface winds, except on the highest peaks, are virtually pure convective winds. Upslope winds



General winds are modified by local wind flow. Weak general winds may exist only at or above ridgetops when strong upslope winds predominate. Upslope winds may establish or intensify wave motion in the general wind flow.



Late afternoon weakening of upslope winds and the onset of downslope flow in the early evening allow the general winds to lower onto exposed upper slopes and ridgetops. If the air being brought in by the general wind is relatively cold, this wind may add to the downslope wind on the lee side of ridges and result in increased speed.

dominate the saddles and lower ridges and combine with upvalley winds to determine wind speeds and directions at the lower elevations.

Late afternoon weakening of upslope winds and the onset of downslope flow in the early evening allow the general winds to lower onto the exposed upper slopes and ridgetops. In the Far West, air in the flow aloft from the North Pacific High is subsiding and, therefore, commonly warm and dry. At night, this air may be found at higher levels at least as far inland as the Sierra-Cascade Range. A fire burning to a ridgetop under the influence of upslope afternoon winds may flare up, and its spread may be strongly affected as it comes under the influence of the general wind flow. Similar phenomena may occur in mountainous country elsewhere.

Valley winds are affected by the general wind flow according to their relative strengths, directions, and temperatures. The degree of interaction also varies from day to night.

The general wind has its maximum effect on valley winds during the daytime when a strong general wind blows parallel to the valley. If the general wind is blowing in the direction of the upvalley wind and the air is relatively unstable, the influence of the general wind will be felt down to the valley floor. The resulting surface wind will be a combination of the general wind and the upvalley wind. When the general wind blows in the direction opposite to the upvalley wind, it extends its influence some distance down into the valley and the observed surface wind will be the resultant of the upvalley and general winds.

General winds blowing at right angles to the axis of a valley during the daytime have much less influence on the valley wind pattern than those blowing along the valley. The ridges tend to shield the valley circulation from the effects of the general wind.

The relative coldness or density of air being brought in by the general winds is an important factor. Relatively warm air will continue to flow aloft without dropping into valleys and canyons and disturbing the convective wind systems. But cold, relatively dense air combined with strong general wind flow tends to follow the surface of the topography, scouring out valleys and canyons and completely erasing the valley wind systems. Such effects are common in cold air following the passage of a cold

front, and in deep layers of cold marine air along the Pacific coast. In these situations the general wind flow is dominant.

These effects are most pronounced when the general wind flow is parallel to the axis of the valley. Strongwinds blowing across narrow valleys and canyons may not be able to drop down into them since momentum may carry the airflow across too quickly. Then, too, there are in-between situations where the general wind flow only partly disturbs the valley wind systems. General winds warm adiabatically as they descend the slopes on the windward side of a valley. If the descending air reaches a temperature equal to that of the valley air, it will leave the slope and cross the valley. The cooler the air flowing in with the general wind, the farther it will descend into the valley.

General winds at night usually have much less effect on valley wind systems than during the daytime. Ordinarily a nighttime inversion forms in the valleys, and this effectively shields the downvalley wind from the general wind flow. Again, there are important exceptions that must be considered.

If the air being brought in by the general wind flow is relatively cold and the direction is appropriate, the general wind can combine with downslope and downvalley winds and produce fairly strong surface winds, particularly during the evening hours. Later during the night, however, further cooling will usually establish a surface inversion and the general wind influence will be lifted to the top of the inversion.

Another important exception is the action of lee-side mountain waves. As was mentioned in the previous chapter, when mountain waves extend down to the surface they will completely obscure valley wind systems. In foehn wind situations this may occur during the day or night, but after the first day of the foehn wind, it is most common during the evening hours.

Downslope Afternoon Winds

An exception to the normal upcanyon, upslope, daytime flow occurs frequently enough on the east slopes of the Pacific Coast Ranges to

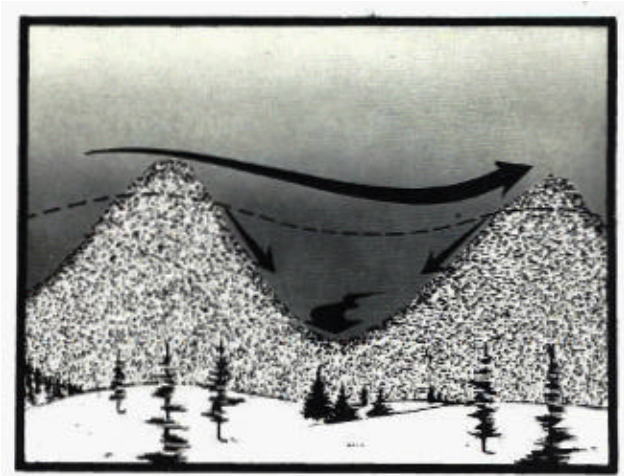

A nighttime inversion in a valley effectively shields the downslope and downvalley winds from the general wind flow above.

warrant further discussion. During the forenoon, in the absence of an overriding general wind flow, local winds tend to be upslope and flow up the draws on both the west and east sides of the Coast Ranges. Usually, the flow through gaps and saddles is easterly because of the stronger heating on the east side in the forenoon. The two flows meet in a convergence zone on the west side of the ridge. By midday the flow up the west slopes has increased, most likely because of the sea breeze or a strengthening of the monsoon circulation due to intensification of the thermal trough. The convergence zone has moved eastward across the ridge, and the flow through the gaps has changed to westerly.

Waves form in this westerly flow, which first remain aloft on the lee side of the mountains, and later surface to cause strong down-slope winds on the east side. Downslope afternoon winds are commonly three times as strong as the forenoon upslope winds. In some areas, downslope afternoon winds occur nearly every day during the warm season, while in other areas they occur only occasionally. The time of the wind shift from upslope to downslope on the east side may vary from late forenoon to late afternoon, but most frequently it is around noon or early afternoon. On some days, up-slope winds redevelop in late afternoon as the mountain waves go aloft. On other days, the downslope afternoon winds diminish and change



During the forenoon in the western Coast Ranges, local winds tend to be upslope and upcanyon on both the east and west sides. The two flows meet in a convergence zone on the west side. If a westerly flow aloft develops, it temporarily rides over the convergence zone and the easterly upslope winds.



On some afternoons the convergence zone moves east as the westerly flow increases. If waves with suitable length and amplitude form in the flow aloft, strong winds blow down the east slopes and east-facing canyons.

WHIRLWINDS

Whirlwinds or dust devils are one of the most common indications of intense local heating. They occur on hot days over dry terrain when skies are clear and general winds are light.

Under intense heating, air near the ground often acquires a lapse rate of 0.2°F. per 10 feet which is about 3½ times the dry-adiabatic rate. The instability is then so extreme that overturning can occur within the layer even in calm air. The superheated air rises in columns or chimneys, establishing strong convective circulations, and drawing in hot air from the surface layer. An upward-spiraling motion usually develops. The spiral is analogous to the whirlpool effect nearly always observed in water draining from a wash basin. The flow becomes spiral because the horizontal flow toward the base is almost invariably off balance.

The lapse rate mentioned in the preceding paragraph is called the autoconvective lapse rate. Greater instability than this may create updrafts spontaneously, but usually a triggering

action initiates the updraft. Updrafts can also begin if the layer acquires only a super-adiabatic lapse rate; that is, a lapse rate less than the autoconvective but greater than the dry-adiabatic rate. However, with superadiabatic lapse rates, quiet surface air actually remains in vertical equilibrium, and becomes buoyant only if it is lifted. In this case, some triggering action must provide the initial impulse upward. One common triggering action is the upward deflection of the surface wind by an obstacle.

It is probable that nearly all updrafts have some whirling motion, but usually this is weak and invisible. The stronger the updraft, the stronger the whirl, because a larger volume of air is drawn into the vortex. The whirling motion intensifies as the air flows toward the center, much the same as the whirling of an ice skater increases as he moves his arms from an extended position to near his body. The whirl becomes visible if the updraft becomes strong enough to pick up sand, dust, or other

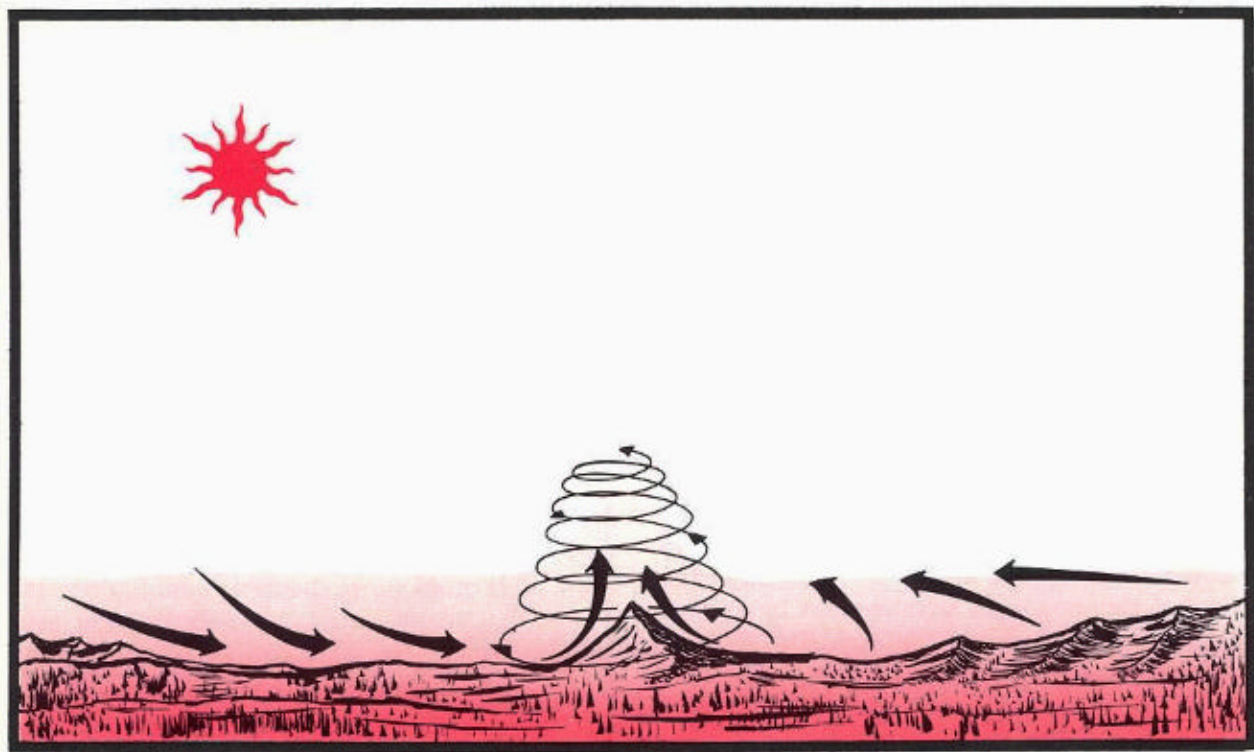

Whirlwinds form when sufficient instability develops in a superheated layer near the ground. The latent energy may be released by some triggering mechanism, such as an obstruction or a sharp ridge. Once convection is established, air in the heated layer is drawn into the breakthrough.

debris. The direction of rotation is accidental, depending on the triggering action. It may be either clockwise or counterclockwise.

Whirlwinds may remain stationary or move with the surface wind. If the triggering action is produced by a stationary object, the whirlwind usually remains adjacent to the object. If it does break away, it may die out and another develops over the object. Those whirlwinds that move show a tendency to move toward higher ground. Some whirlwinds last only a few seconds, but many last several minutes and a few have continued for several hours.

The sizes of whirlwinds vary considerably. Diameters range from 10 to over 100 feet, and heights range from 10 feet to 3,000 or 4,000 feet in extreme cases. Wind speeds in the whirlwinds are often more than 20 m.p.h. and in some cases have exceeded 50 m.p.h. Upward currents may be as high as 25 to 30 m.p.h. and can pick up fair-sized debris.

Whirlwinds are common in an area that has just burned over. The blackened ashes and

charred materials are good absorbers of heat from the sun, and hotspots remaining in the fire area may also heat the air. A whirlwind sometimes rejuvenates an apparently dead fire, picks up burning embers, and spreads the fire to new fuels.

Firewhirls

The heat generated by fires produces extreme instability in the lower air and may cause violent firewhirls. Such firewhirls have been known to twist off trees more than 3 feet in diameter. They can pick up large burning embers, carry them aloft, and then spew them out far across the fireline and cause numerous spot fires. At times, the firewhirls move bodily out of the main fire area, but as soon as they do the flame dies out and they become ordinary whirlwinds moving across the landscape.

Firewhirls occur most frequently where heavy concentrations of fuels are burning and a large amount of heat is being generated in a small area. Mechanical forces are often present

which serve as triggering mechanisms to start the whirl. A favored area for firewhirls is the lee side of a ridge where the heated air from the fire is sheltered from the general winds. Mechanical eddies produced as the wind blows across the ridge can serve as the triggering mechanism to initiate the whirl. The wind may add to the instability by bringing in cool air at higher levels over the fire-

heated air on the lee side. Air streams of unequal speeds or from different directions in adjacent areas can mechanically set off firewhirls in fire-heated air. Firewhirls have also been observed in relatively flat terrain. In these cases the whirls seem to start when a critical level of energy output has been reached by a portion of the fire.

THUNDERSTORM WINDS

Special winds associated with cumulus cloud growth and thunderstorm development are true convective winds. For that reason they will be described here, even though we will consider them again when we look into the stages of thunderstorm development in chapter 10. These winds are (1) the updrafts predominating in and beneath growing cumulus clouds, (2) downdrafts in the later stages of full thunderstorm development, and (3) the cold air outflow which sometimes develops squall characteristics.

There are always strong updrafts within growing cumulus clouds, sometimes 30 m.p.h. or more even if the cumulus does not develop into a thunderstorm. Ordinarily, the air feeding into the cloud base is drawn both from heated air near the surface and from air surrounding the updraft. The indraft to the cloud base may not be felt very far below or away from the cloud cell. A cell that forms over a peak or ridge, however, may actually increase the speed of upslope winds that initiated the cloud formation. A cumulus cloud formed elsewhere that drifts over a peak or ridge also may increase the upslope winds while the cloud grows with renewed vigor. With continued drift, the cloud may draw the ridgetop convection with it for a considerable distance before separating.

If a cumulus cloud develops into a mature thunderstorm, falling rain within and below the cloud drags air with it and initiates a downdraft. Downward-flowing air, which remains saturated by the evaporation of raindrops, is ordinarily warmed at the moist-adiabatic rate. But air being dragged downward in the initial stages of a thunderstorm downdraft is warmed at a lesser rate because of entrainment of surrounding cooler air and the presence of cold raindrops or ice crystals. If this air

is dragged downward to a point where it is colder than the surrounding air, it may cascade to the ground as a strong downdraft. In level terrain this becomes a surface wind guided by the direction of the general wind and favorable airflow channels. This is known as the first gust and will be treated more fully in chapter 10.

In mountainous terrain the thunderstorm downdraft tends to continue its downward path

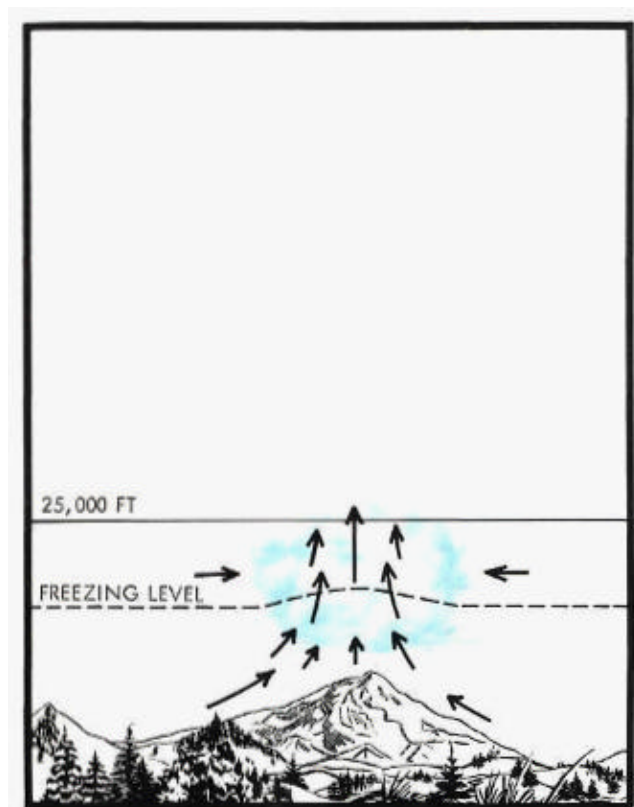

The updraft into cumulus clouds that form over peaks and ridges may actually increase the upslope winds that initiated the cloud formation

into the principal drainage ways. Speeds of 20 or 30 m.p.h. are common, and speeds of 60 to 75 m.p.h. have been measured. If it is dense enough, the air has sufficient momentum to traverse at least short adverse slopes in its downward plunge. The high speeds and surface roughness cause these winds to be extremely gusty. They are stronger when the air mass is hot, as in the late afternoon, than during the night or forenoon. Although they strike suddenly and violently, downdraft winds are of short duration.

Although downdraft winds are a common characteristic of thunderstorms, it is not necessary for developing cumulus clouds to reach the thunderstorm stage for downdrafts to occur. Downdrafts can develop on hot days from towering cumulus clouds producing only high-level precipitation.

Squall winds often precede or accompany thunderstorms in the mountainous West. These storms often cool sizeable masses of air covering an area of a hundred or several hundred square miles. Occurring as they do in the warm summer months, these cool air masses are in strong temperature contrast with their surroundings. As this air spreads out and settles to lower levels, the leading edge—a front—is accompanied by squall winds. These are strong and gusty; they begin and end quickly. They behave much like wind in squall lines ahead of cold fronts, but are on a smaller geographic scale. However, they may travel out many miles beyond the original storm area.

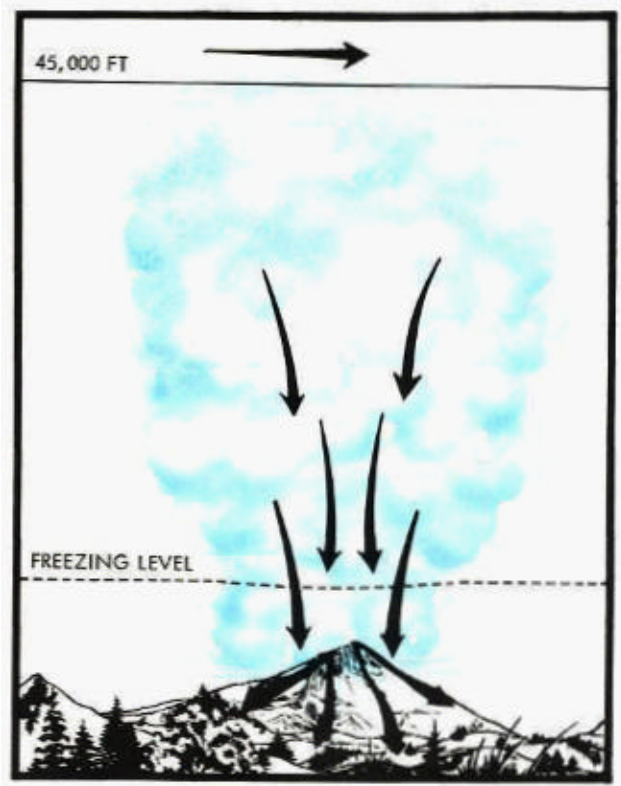

The downdraft in a mature thunderstorm continues out of the base of the cloud to the ground and, being composed of cold air, follows the topography. It strikes suddenly and violently, but lasts only a short time.

SUMMARY

In this chapter on convective winds we have included local winds, which are produced by local temperature differences. Any factors affecting heating and cooling will influence convective winds. These winds will also be affected by the general wind flow. The most familiar convective winds are land and sea breezes, valley and slope winds, whirlwinds, and winds associated with convective cumulus and thunderstorm clouds.

In the land- and sea-breeze system, the local winds are due to land-water temperature differences, which, in turn, produce differences in the temperature of the overlying air. Slope winds are due to temperature differences between slope air

and air over the valley. Valley winds likewise result from temperature differences between valley air and air at the same elevation over the plains. Strong local heating will develop a very unstable layer of air near the surface, and the sudden release of this concentrated energy, usually following a triggering action, may produce whirlwinds.

Thermal updrafts resulting from local heating may produce cumulus clouds, which, under suitable moisture and instability conditions, may develop into thunderstorms. Up-drafts are convective winds characteristic of developing cumulus clouds, but downdrafts are produced in thunderstorms after precipitation

Begins falling from the cloud.

Having considered the general circulation and general convective, winds, we will now turn

to the subject of air masses and fronts, and the weather associated with them.

Chapter 8

AIR MASSES AND FRONTS

The day-to-day fire weather in a given area depends, to a large extent, on either the character of the prevailing air mass, or the interaction of two or more air masses.

The weather within an air mass—whether cool or warm, humid or dry, clear or cloudy—depends on the temperature and humidity structure of the air mass. These elements will be altered by local conditions, to be sure, but they tend to remain overall characteristic of the air mass. As an air mass moves away from its source region, its characteristics will be modified, but these changes, and the resulting changes in fire weather, are gradual from day to day.

When one air mass gives way to another in a region, fire weather may change abruptly—sometimes with violent winds—as the front, or leading edge of the new air mass, passes. If the frontal passage is accompanied by precipitation, the fire weather may ease. But if it is dry, the fire weather may become critical, if only for a short time.

AIR MASSES AND FRONTS

In chapter 5 we learned that in the primary and secondary circulations there are regions where high-pressure cells tend to form and stagnate. Usually, these regions have uniform surface temperature and moisture characteristics. Air within these high-pressure cells, resting or moving slowly over land or sea areas that have uniform properties, tends to acquire corresponding characteristics—the coldness of polar regions, the heat of the tropics, the moisture of the oceans, or the dryness of the continents.

A body of air, usually 1,000 miles or more across, which has assumed uniform characteristics,

is called an air mass. Within horizontal layers, the temperature and humidity properties of an air mass are fairly uniform. The depth of the region in which this horizontal uniformity exists may vary from a few thousand feet in cold, winter air masses to several miles in warm, tropical air masses.

Weather within an air mass will vary locally from day to day due to heating, cooling, precipitation, and other processes. These variations, however, usually follow a sequence that may be quite unlike the weather events in an adjacent air mass.

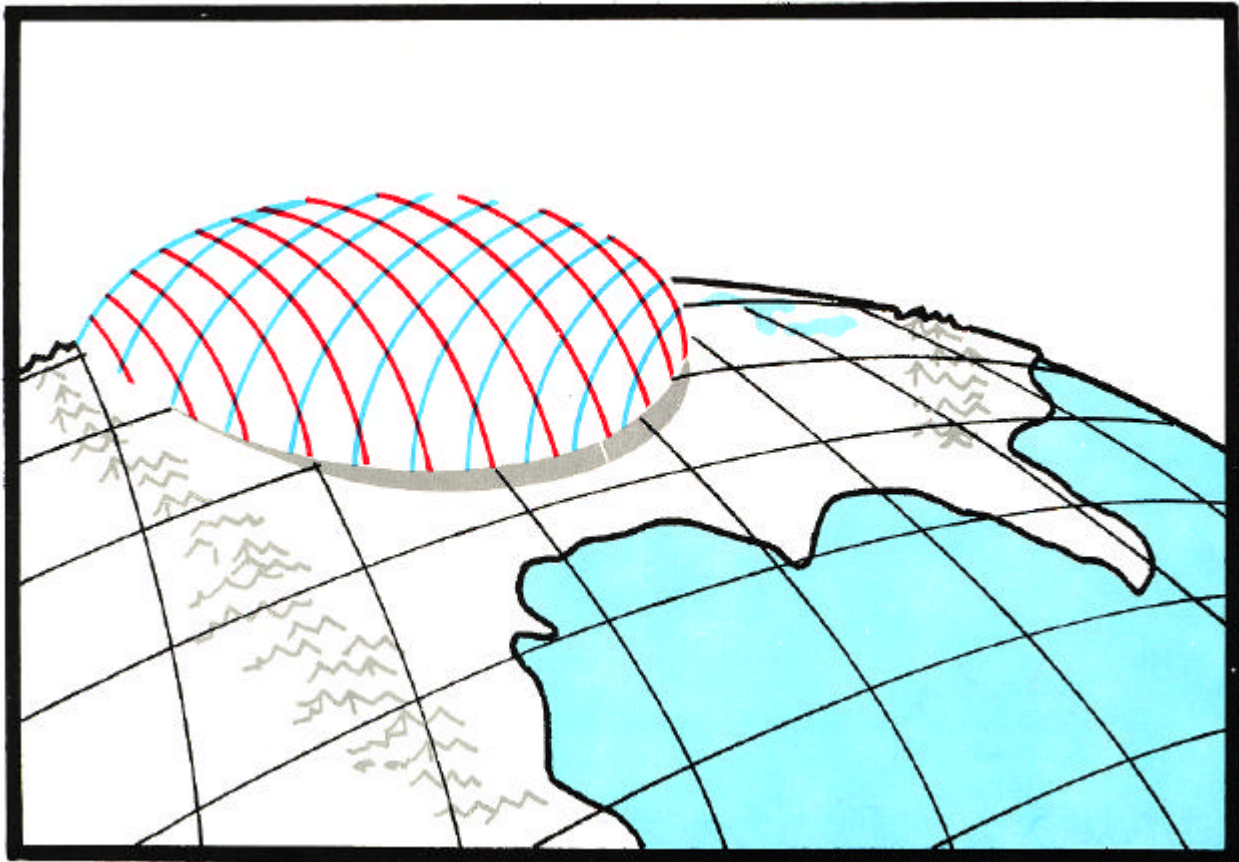

A body of air, usually 1,000 miles or more across, which has assumed uniform characteristics of temperature and moisture, is called an air mass.

Where two or more air masses come together, the boundary between them may be quite distinct; it is called a front. Frontal zones, where lighter air masses are forced over denser air masses, are regions of considerable weather activity.

In this chapter, we will consider first the different types of air masses and the weather associated with them, and then the different kinds of fronts and frontal weather.

FORMATION AND MODIFICATION OF AIR MASSES

The region where an air mass acquires its characteristic properties of temperature and moisture is called its source region. Ocean areas, snow- or ice-covered land areas, and wide desert areas are common source regions. Those areas producing air masses which enter the fire-occurrence regions of North America are:

1. The tropical Atlantic, Caribbean, Gulf of Mexico, and the tropical Pacific, which are uniformly warm and moist.
2. The Northern Pacific and Northern Atlantic, which are uniformly cool and moist.
3. Interior Alaska, Northern Canada, and the Arctic, which are uniformly cold and dry during the winter months.
4. Northern Mexico and Southwestern United States, which are usually hot and dry during the summer months.

The time required for a body of air to come to approximate equilibrium with the surface over

which it is resting may vary from a few days to 10 days or 2 weeks, depending largely on whether the body of air is initially colder or warmer than the temperature of its source region. If the air is colder, it is heated from below. Convective currents are produced, which carry the heat and moisture aloft and rapidly modify the air to a considerable height.

On the other hand, if the air is initially warmer than the surface, it is cooled from below. This cooling stabilizes the air and cuts off convection. Cooling of the air above the surface must take place by conduction and radiation, and these are slow processes. Thus, a longer time—up to 2 weeks—is required for the development of cold air masses, and even then these air masses are only a few thousand feet thick.

Air masses that form over a source region vary in temperature and moisture from season to season, as does the source region. This is particularly true of continental source regions. High-latitude continental source regions are much colder and drier in the winter than in the summer, and tropical continental source regions are much hotter and drier in summer than in winter.

Air masses are classified according to their source region. Several systems of classification have been proposed, but we will consider only the simplest. Air masses originating in high latitudes are called polar (P), and those originating in tropical regions are called tropical (T). Air masses are further classified according to the underlying surface in the source region as maritime for water and continental for land. The “m” for maritime or “c” for continental precedes the P or T. Thus, the four basic types of air masses are designated as: mP, mT, cP, and cT, according to their source region. It is natural that air stagnating for some time in a polar region will become cold, or in a tropical region will become warm. And air spending sometime over water becomes

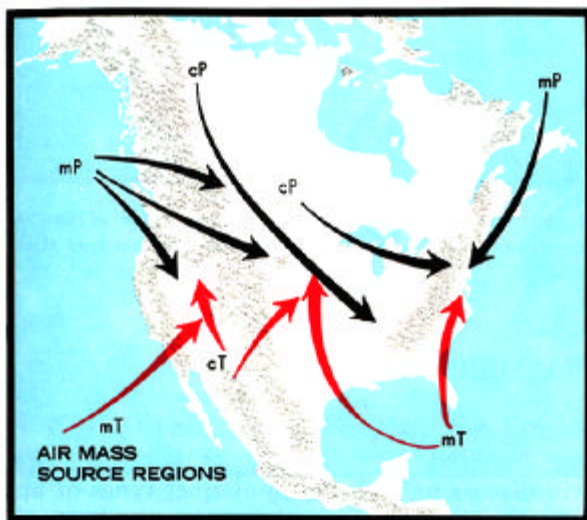

The oceans and the land are both important air-mass sources.

moist, at least in the lower layers, while air over land becomes dry.

For convenience, the four basic air mass types are often referred to as moist cold, moist warm, dry cold, and dry warm.

As an air mass leaves its source region in response to broadscale atmospheric motions, it may be colder or warmer than the surface it passes over. It is then further classified by the addition of **k for colder** or **w for warmer** to its classification symbol. The k-type air mass will be warmed from below and will become unstable in the lower layers. A w-type air mass will be cooled from below, will become stable, and will be modified slowly, and only in the lower few thousand feet.

Air-mass properties begin changing as soon as the air mass leaves its source region. The amount of modification depends upon the speed with which the air mass travels, the type of surface over which it moves, and the temperature difference between the air mass and the underlying surface.

Air masses are modified in several ways. For the most part, these are processes which we have already considered in detail. Several of the processes usually take place concurrently:

1. An air mass is heated from below if it passes over a warmer surface (previously warmed by the sun) or if the surface beneath a slow-moving air mass is being currently warmed by the sun. Such modification is rapid because of the resulting instability and convection.

2. An air mass is cooled from below if it passes over a colder surface, or if the surface is cooled by radiation. This increases the stability of the lower layers, and further modification becomes a slow process.

3. Moisture may be added to an air mass by:
(a) Evaporation from water surfaces, moist ground, and falling rain; (b) sublimation from ice or snow surfaces and falling snow or hail; and (c)

transpiration from vegetation. Of these, sublimation is a relatively slow process by comparison.

4. Moisture may be removed from an air mass by condensation and precipitation.

5. Finally, air-mass properties may be changed by turbulent mixing, by sinking, or by lifting.

After moving a considerable distance from its source region, particularly after entering a source region of another type, an air mass may lose its original distinctive characteristics entirely and acquire those of another air-mass type. Thus, a continental polar air mass moving out over the Gulf of Mexico takes on the characteristics of a maritime tropical air mass. Or a maritime polar air mass, after crossing the Rocky Mountains, may assume the characteristics of a continental polar air mass.

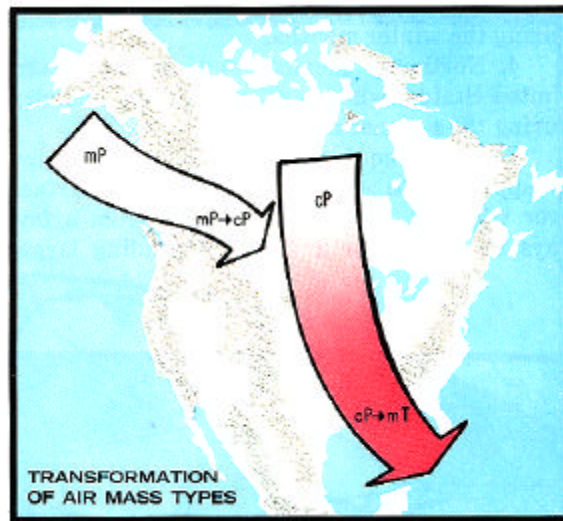

An air mass which moves into the source region of another air-mass type, and stagnates, is transformed into that type of air mass.

AIR-MASS WEATHER

There are many differences in air masses and in the weather associated with them. Even within one air-mass type, there will be considerable variation, depending on the season, the length of time that an air mass has remained

over its source region, and the path it has followed after leaving that region. We will discuss only the more distinct types of air masses and consider their most common characteristics.

Continental Polar—Winter

Continental polar air masses originate in the snow-covered interior of Canada, Alaska, and the Arctic in the colder months. Lower layers of the air become quite cold, dry, and stable. Much moisture from the air is condensed onto the snow surface. These air masses are high-pressure areas, and there is little cloudiness due to the lack of moisture and to the stability of the air mass.

These are the coldest wintertime air masses, and cause severe cold waves when moving southward through Canada and into the United States. Upon moving southward or southeastward over warmer surfaces, cP air masses change to cPk. The lower layers become unstable and turbulent. If a part of the air mass moves over the Great Lakes, it picks up moisture as well as heat and may produce cloudiness and snow flurries or rain showers on the lee side of the Lakes, and again on the windward side of the Appalachian Mountains. Once across the Appalachians, the air mass is generally clear and slightly warmer.

If a cP air mass moves southward into the Mississippi Valley and then into the Southeast, it will gradually warm up but remain dry. Modification is slow until the air mass passes beyond the snow-covered areas; then it becomes more rapid. When cP air moves out over the Gulf of Mexico, it is rapidly changed to an mT air mass. The generally clear skies and relatively low

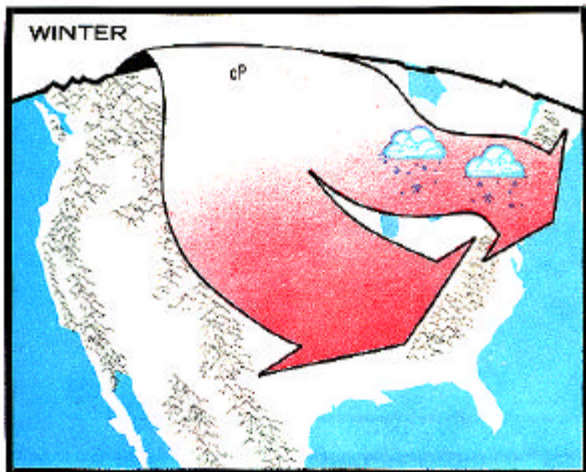

Continental polar air masses in winter cause severe cold waves when they move southward through Canada and into the Central and Eastern United States.

humidities associated with cP air masses are responsible for much of the hazardous fire weather in the South and Southeast during the cool months.

The Rocky Mountains effectively prevent most cP air masses from moving into the Far West. But occasionally, a portion of a deep cP air mass does move southward west of the Rockies, and in so doing brings this area its coldest weather. At times the air is cold enough for snow to fall as far south as southern California.

Maritime Polar—Winter

The North Pacific is the common source region for maritime polar air masses. While in its source region, the air mass is cold and has a lapse rate nearly the same as the moist-adiabatic rate. If the air mass moves into the snow-covered regions of Canada, it gradually changes to a cP air mass. Maritime polar air taking that trajectory usually has had a comparatively short stay over the water. It is quite cold and has high relative humidity, but moisture content in terms of absolute humidity is rather low. However, rain or snow showers usually result as the air is lifted over the coastal mountains.

Maritime polar air masses originating farther south and entering Western United States or Southwestern Canada have had a longer overwater trajectory, are not quite so cold, and have a higher moisture content. On being forced over the Coast Ranges and the Rocky Mountains, an mP air mass loses much of its moisture through precipitation. As the air mass descends on the eastern slopes of the Rocky Mountains, it becomes relatively warm and dry with generally clear skies. If, however, it cannot descend on the lee side of the mountains, and instead continues eastward over a dome of cold cP air, snow may occur.

East of the Rockies, mP air at the surface in winter is comparatively warm and dry, having lost much of its moisture in passing over the mountains. Skies are relatively clear. If this air mass reaches the Gulf of Mexico, it is eventually changed into an mT air mass.

Maritime polar air sometimes stagnates in the Great Basin region of the Western United

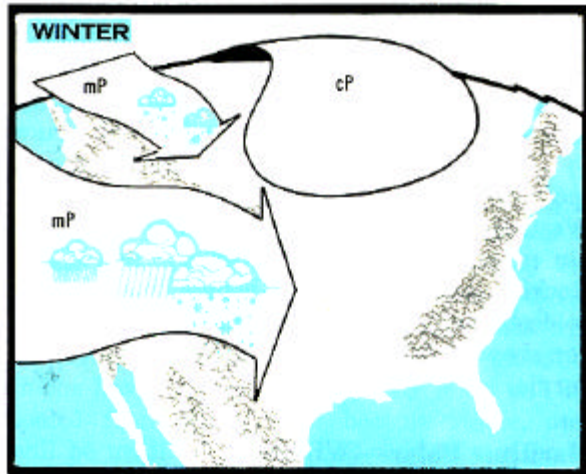

Maritime polar air masses in winter vary according to the length of time they spend in the source region. Those entering the continent farther north usually have spent only a short time over the water and are cool and quite dry, but showers may occur in the mountains. Those entering the west coast farther south are more moist and produce much rain and snow, particularly in the mountains.

States in association with a Great Basin High. The outflow from the Great Basin High may give rise to strong, dry foehn winds in a number of the surrounding States.

At times during the winter, mP air is trapped in Pacific coast valleys and may persist for a week or more. Low stratus clouds and fog are produced, making these valleys some of the foggiest places on the continent during the winter.

Although mP air forms over the North Atlantic Ocean, as well as the North Pacific, the trajectory of Atlantic mP air is limited to the northeastern seaboard.

Maritime Tropical - Winter

Most of the maritime tropical air masses affecting temperate North America originate over the Gulf of Mexico or Caribbean Sea. They are warm, have a high moisture content, and a conditionally unstable lapse rate. Maritime tropical air is brought into the southeastern and central portions of the country by the circulation around the western end of the Bermuda High. In moving inland during the winter, mT air is cooled from below by contact with the cooler continent and becomes stabilized in the lower levels. Fog and low

stratus clouds usually occur at night and dissipate during the day as this air mass invades the Mississippi Valley and the Great Plains. If mT air is lifted over a cP air mass, or if it moves northeastward and is lifted on the western slopes of the Appalachians, the conditional instability is released and large cumulus clouds, heavy showers, and frequent thunderstorms result.

Maritime tropical air seldom reaches as far as the Canadian border or the New England States at the surface in winter. Nevertheless, it occasionally causes heavy rain or snow in these areas, when mT air encounters a colder cP or mP air mass and is forced to rise up over the denser air. More will be said about this process in the section on fronts.

The tropical Pacific is also a source region for mT air, but Pacific mT seldom enters the continent. When it does, it is usually brought in with a low-pressure system in Northern Mexico or California, where the Pacific mT air can cause heavy rainfall when rapidly forced aloft by the mountains.

Continental Polar-Summer

In summer, even though the source region for cP air masses is farther north than in winter—over Northern Canada and the polar regions—the warmer surface temperatures result in little surface cooling and frequently in

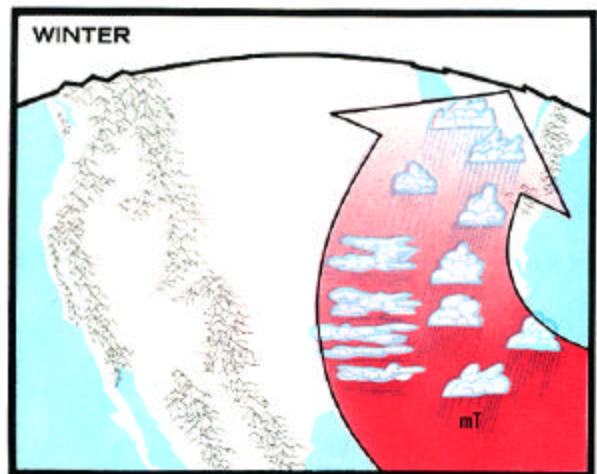

Maritime tropical air in winter produces nighttime cloudiness and fog in the Mississippi Valley and Great Plains and showers or snow over the Appalachians and in areas where it overruns a cooler air mass.

actual heating of the air near the ground. The air mass, therefore, may be relatively unstable in the lower layers in contrast to its extreme stability during the winter. Since the air is quite dry from the surface to high levels, the relative instability rarely produces cloudiness or precipitation.

The general atmospheric circulation is weaker during the summer, and polar outbreaks move more slowly than in winter. As a result, cP air undergoes tremendous changes in passing slowly from its source region to Southern United States. During its southward and southeastward travel, cP air is warmed from below and becomes more unstable.

Continental areas, over which cP air travels, are relatively moist in summer, being largely covered with crops, grass, forests, and other vegetation. Transpiration from these plants and evaporation from water bodies and moist soil increase the moisture content of cP air rather rapidly. As the moisture content increases, cloudiness also increases.

The weather associated with cP air as it passes through Canada and enters the United States is generally fair and dry. **Frequent intrusions of this air give rise to much of the fire weather in the north-central and northeastern regions from**

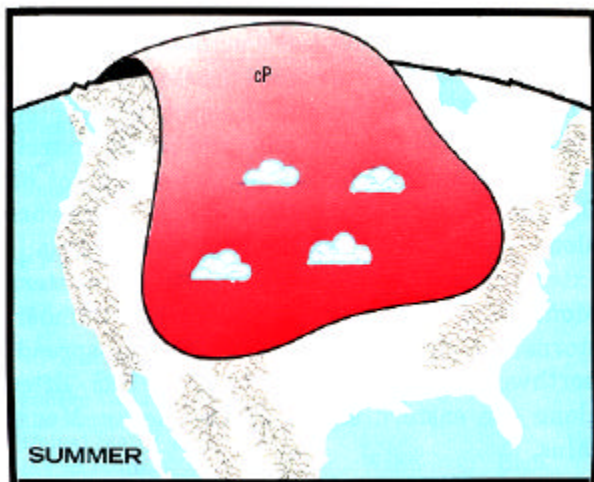

Continental polar air in summer brings generally fair and dry weather to the central and eastern portions of the continent. The air mass warms rather rapidly and becomes unstable as it moves southward. It may pick up enough moisture to produce some clouds.

spring, through summer, and into fall.

Occasionally, cP air stagnates in the Southeastern United States and accumulates sufficient moisture to produce showers and isolated thunderstorms, particularly over mountainous areas.

Maritime Polar—Summer

Maritime polar air masses in summer originate in the same general area over the Pacific Ocean as in winter. In summer, however, the ocean is relatively cool compared to the land surfaces. Summer mP air is cooled from below in its source region and becomes stable. Stability in the lower layers prevents moisture from being carried to higher levels. Aloft, this air mass remains very dry, usually even drier than summer cP, and becomes quite warm through the subsidence which takes place in the Pacific High.

As mP air approaches the Pacific coast, the cold, upwelling waters along the shore cause further cooling, increasing relative humidity, and stimulating the formation of considerable fog or low stratus clouds. Thus, along the Pacific coast, summer mP is characterized by a cool, humid marine layer from 1,000-2,000 feet thick, often with fog or low stratus clouds, a strong inversion capping the marine layer, and warm, dry, subsiding air above.

As mP air moves inland from the west coast, the strong daytime heating in interior California, Oregon, Washington, and portions of British Columbia warms the surface layers and lowers the relative humidity. The intense heating and the lifting as mP air crosses the mountains may result in cumulus cloud formation and occasional scattered showers and thunderstorms at high elevations. In descending the eastern slopes of the Rockies, summer mP is heated adiabatically as in winter, and the relative humidity may become quite low at times. When it arrives in the Plains and the Mississippi Valley, it is hardly distinguishable from cP air in the area and results in clear, dry weather. Continuing eastward, it becomes warmer and more unstable, and picks up moisture from the earth and plants. By the time it reaches the Appalachians, it has become unstable and moist enough so that lifting can again produce showers or thunderstorms.

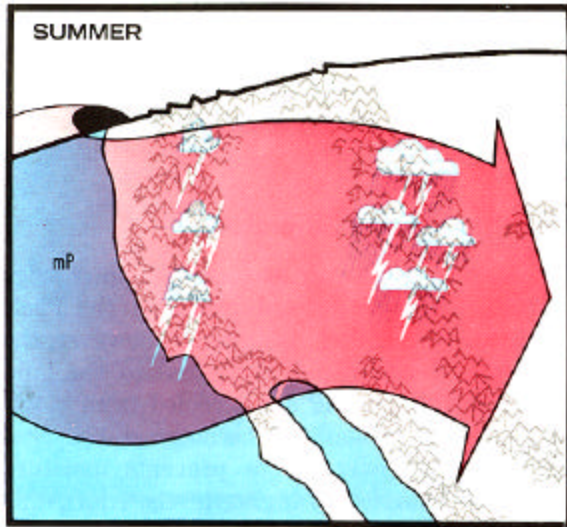

Stratus clouds and fog along the Pacific coast are characteristic of mP air in summer. Heating and lifting of the air are likely to produce clouds in the Sierras and showers or thunderstorms in the Rockies if sufficient moisture is present.

Maritime polar air formed over the colder waters of the North Atlantic in summer occasionally moves southward bringing cool weather and cloudiness to the Atlantic coastal areas.

Maritime Tropical—Summer

Maritime tropical air in its source region over the Gulf of Mexico and the Caribbean in summer has properties similar to those in winter, except that it is conditionally unstable to higher levels, slightly warmer, and more moist. In summer, mT air invades central and eastern North America very frequently, sometimes penetrating as far north as Southern Canada, bringing with it the typical heat and oppressive humidity of those tropical source regions.

Daytime heating of the air as it moves inland produces widespread showers and thunderstorms, particularly, during the afternoon and evening. At night, there may be sufficient cooling of the earth's surface to bring the temperature of the air near the ground to the dew point and produce fog or stratus clouds. This is dissipated in the early morning by surface heating.

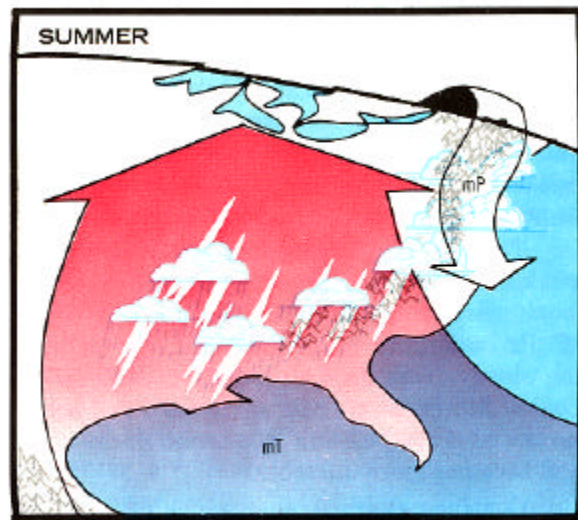

Maritime tropical air moving onto the continent is conditionally unstable. Daytime heating and orographic lifting produce showers and thunderstorms in this warm, humid air mass.

When mT air is lifted, either by crossing mountains or by being forced to rise over cooler mP or cP air, widespread clouds, numerous showers, and intense thunderstorms are produced.

Although some of the summer thunderstorm activity in Northern Mexico and the Southwestern United States is the result of mT air from the tropical Pacific, most of it is associated with mT air from the Gulf of Mexico. This moist air is usually brought in at intermediate levels by easterly and southeasterly flow. Heating and lifting by mountains set off thunderstorms as the air spreads northward along the Sierra-Cascade range, occasionally extending as far as northern Idaho, western Montana, and Southern Canada. Some thunderstorm activity develops as mT air spreads northwestward from the Gulf and is lifted along the eastern slopes of the Rocky Mountains.

On rare occasions, mT air originating in the tropical Pacific spreads northward over Northwestern Mexico and California with thunderstorm activity. Usually this is residual mT air from a dying tropical storm.

Continental Tropical—Summer

The only source regions for continental tropical air in North America are Mexico and the Southwestern United States. This air mass is hot, dry, and unstable, and causes droughts and heat waves when it persists for any length of time. It is similar to the upper-level, subsiding air in the Pacific High, and may actually be produced by subsidence from aloft.

ward and northward to cover portions of the Central or Western United States. Because of its heat and dryness, it has a desiccating effect on wildland fuels, setting the stage for serious fire-weather conditions.

Characteristics of winter and summer air masses are summarized in the following tables.

Air mass	Lapse rate	Temperature	Characteristics of Winter Air Masses			Precipitation
			Surface RH	Visibility	Clouds	
cP at source region	Stable	Cold	High	Excellent	None	None
cP over mid-continent, South-eastern Canada and Eastern United States	Variable	do.	Low	Good, except in industrial areas and in snow flurries	Stratocumulus in hilly regions, stratocumulus or cumulus along lee shores of Great Lakes	Snow flurries in hilly areas and along lee shores of Great Lakes
mP at source region	Unstable	Moderately cool	High	Good	Cumulus	Showers
mP over west coast	do.	Cool	do.	do.	do.	do.
mP over Rockies	do.	do.	do.	Good, except in mountains and during precipitation	do.	Showers or snow
mP over mid-continent, South-eastern Canada, and Eastern United States	Stable	Mild	Low	Good, except near industrial areas	None, except in mountains	None
mT at source region	Unstable	Warm	High	Good	Cumulus	Showers
mT over Southern United States	Stable in lower layers	do.	do.	Fair in afternoon, poor with fog in early morning	Stratus and stratocumulus	Rain or drizzle

In summer, cT air sometimes spreads east-

Characteristics of Summer Air Masses

Air mass	Lapse rate	Temperature	Characteristics of Summer Air Masses			Precipitation
			Surface RH	Visibility	Clouds	
cP at source region	Unstable	Cool	Low	Good	None or few cumulus	None
cP over mid-continent, South-eastern Canada, and Eastern United States	do.	Moderately cool	do.	Excellent	Variable cumulus	None
mP at source region	Stable	Cool	High	Fair	Stratus, if any	None
mP over west coast	do.	do.	do.	Good, except poor in areas of fog	Fog or stratus	None
mP over Rockies	Unstable	Moderately cool	Moderate	Good	Cumulus	Showers at high elevations
mP over mid-continent, South-eastern Canada, and Eastern United States	do.	Warm	Low	do.	Few cumulus	Showers wind ward side of Appalachians
mT at source region	do.	Warm	High	do.	Cumulus, if any	Showers
mT central and eastern continent	do.	Hot	Moderate	Good during day except in showers; poor with fog in early morning	Fog in morning, cumulus or cumulonimbus in afternoon	Showers or thunderstorms
	Unstable	Hot	Low	Good except in dust storms	None	None

VARIATIONS IN AIR-MASS WEATHER

We have considered the usual characteristics of the principal air masses in winter and in summer. We must realize, however, that there are many variations in individual air masses— variations from day to night, and seasonal variations other than just in winter and summer. We will consider a few general principles to help us understand these variations.

1. If the surface over which an air mass is located is warmer than the air mass, the lower layers will be heated. This results in increased instability, convective mixing and turbulence, and a lowering of surface relative humidity. If sufficient moisture is present, cumulus clouds and possible showers may be formed. The increased mixing generally results in good visibility.

2. If the surface is colder than the air mass, the lower layers are gradually cooled. This increases the stability and retards convective mixing and turbulence. Water vapor and atmospheric impurities tend to be concentrated in the lower layers, and visibility is decreased. With sufficient moisture, fog and low stratus clouds will form.

3. As a rule, air masses over land and away from their source region tend to be cooler than the surface during the day, and warmer than the surface at night. Thus, the weather characteristics change accordingly from day to night.

4. In the spring, land surfaces away from source regions warm faster than the water or snow-covered surfaces at source regions. This leads to increased instability in the lower layers as air masses leave their source region, and causes considerable thunderstorm activity, hail, and, sometimes, tornadoes.

5. During the summer, there is the least temperature difference between polar and tropical regions. The general circulation is weaker so that air masses move more slowly, and spending more time in transit, are thus more subject to modification. The belt of westerlies is farther north than in winter. As a result, tropical air masses penetrate far to the north, but polar air masses are

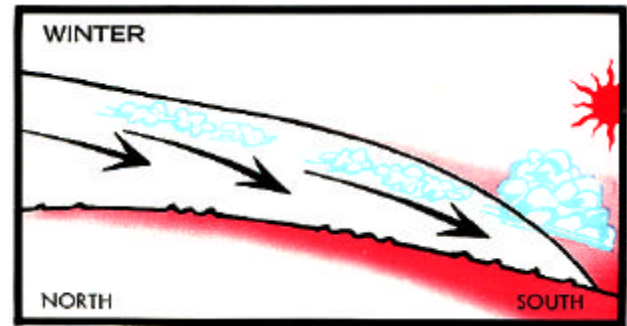
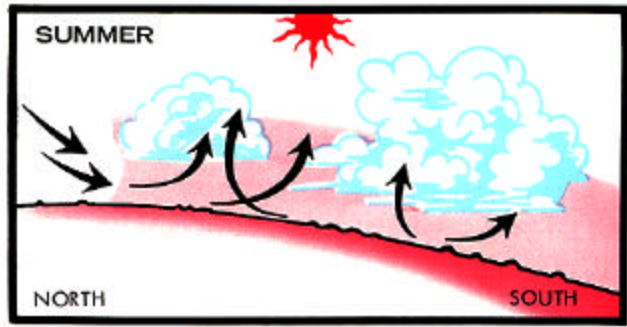

In summer, because of the weaker general circulation, air masses move more slowly and are subject to greater modification. In winter, when the general circulation is stronger, cold polar air masses move rapidly away from their source region and penetrate far southward with little modification.

blocked at high latitudes and do not penetrate far southward.

6. As the earth's surface begins to cool in the fall, air masses tend to be more stable in the lower layers, and thunderstorm activity is reduced. As fall progresses and winter approaches, stable cold air near the surface becomes deeper and more persistent, encouraging the formation of fog or low stratus clouds.

7. During the winter, cold polar air masses move at a faster rate and penetrate far southward. The temperature contrast between polar and tropical regions increases, as does the speed of the general circulation.

FRONTS

We have seen that polar air masses have time ocean origin are different from those of properties very different from those of tropical

continental origin. Because the various types of air masses, and that air masses having a man- masses move into the middle latitudes, it is

inevitable that they meet somewhere and interact. Since air masses have different densities, they tend not to mix when they come together. Instead, a discontinuity surface, or front, is found between them (see page 129).

Some of the weather conditions most adverse to fire control, such as strong, gusty winds, turbulence, and lightning storms, occur in frontal zones. Sometimes there is insufficient moisture in the warm air mass, or inadequate lifting of this mass, so that no precipitation occurs with the front. Strong, gusty, and shifting winds are typical of a dry frontal zone, adding greatly to the difficulty of fire control.

In a frontal zone, the warmer air mass, being lighter, will be forced over the colder air mass. The rotation of the earth deflects the movement of both the cold and the warm air masses as one tries to overrun or override the other, and prevents the formation of a horizontal discontinuity surface. Instead, the frontal surface **slopes up** over the colder air. The slope varies from about 1/50 to 1/300. A 1/50 slope means that for every 50 miles horizontally, the front is 1 mile higher in the vertical. The amount of slope is dependent upon the temperature contrast between the two air masses, the difference in wind speed across the front, and the relative movements of the air masses involved; that is, whether cold air is replacing warm air at the surface or warm air is replacing cold air. On a surface weather map, only the intersection of the frontal surface with the earth is indicated. The contrast between the air masses is strongest near the earth's surface, and decreases upward in the atmosphere.

The central portions of air masses are usually associated with areas of high pressure, but fronts are formed in troughs of low pressure. From a position on a front, we find that the pressure rises both toward the warmer air and toward the colder air. Because the gradient wind in the Northern Hemisphere always blows with high pressure on the right, as one faces downstream, this means that the wind blows in one direction in the cold air and a different direction in the warm air. At a given location, shown in chapter 6, the wind shifts in a clockwise direction as a front passes—for example,

from southeast to southwest or from southwest to northwest.

The wind-shift line and pressure trough line provide good clues to the weatherman for the location of fronts, but there are other indications to consider. A temperature discontinuity exists across a front. As a rule, the greater and more abrupt the temperature contrast, the more intense the front. Weak fronts are characterized by gradual and minor changes in temperature. The moisture contrast between air masses on different sides of a front may be indicated by the dew-point temperatures. Usually the cold air mass will be drier than the warm air mass. Other indications of front location are cloud types, pressure changes, and visibility changes.

Types of fronts are distinguished by the way they move relative to the air masses involved. If a front is moving so that cold air is replacing warm air, it is a cold front. If the warm air is advancing and replacing cold air ahead, the front is a warm front. If a front is not moving, it is a stationary front. Cold fronts are indicated on weather maps by pointed cusps, and warm fronts by semicircles, on the side toward which they are moving. A stationary front is indicated by a combination of both. (See sketch.)

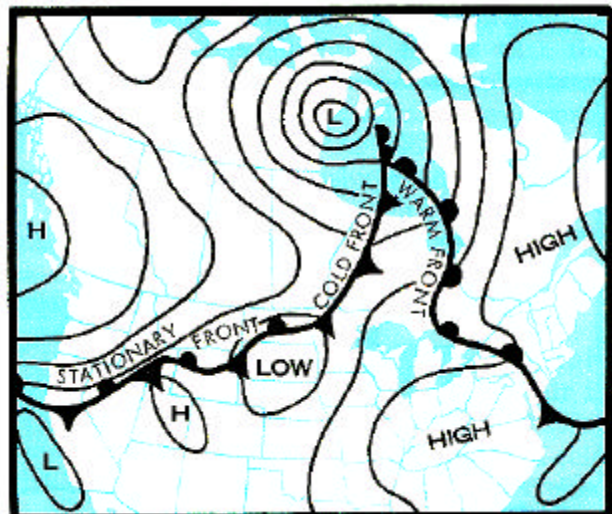

Fronts are classified by the way they move relative to the air masses involved. At a cold front, cold air is replacing warm air. At a warm front, warm air is replacing cold air. A stationary front, as the name implies, is temporarily stalled.

Cold Fronts

The leading edge of an advancing cold air mass is a cold front. It forms a wedge which pushes under a warm air mass forcing the warm air to rise. Because of surface friction, the lowest layers of the cold air are slowed down. This increases the steepness of the frontal surface and causes a cold front to have a blunted appearance when viewed in cross-section. The slopes of cold fronts usually vary between 1/50 to 1/150.

There are wide variations in the orientation and speed of cold fronts. Usually, they are oriented in a northeast-southwest direction, and they move to the east and southeast, at speeds varying from about 10 to 40 m.p.h. and faster in the winter.

As a cold front approaches, the southerly winds increase in the warm air ahead of the front. Clouds appear in the direction from which the front is approaching. The barometric pressure usually falls, reaches its lowest point as the front passes, then rises sharply. Winds become strong and gusty and shift sharply to westerly or northwesterly as the cold front passes. Temperature and dew point are lower after the cold front passes. In frontal zones with precipitation, the heaviest precipitation usually occurs with the passage of the front. Then it may end quickly and be followed by clearing weather.

There are many exceptions to the foregoing general pattern of cold-front passages. The severity of the weather associated with cold fronts depends upon the moisture and stability of the warm air, the steepness of the front, and the speed of the front. Since cold fronts are usually steeper and move faster than warm fronts, the accompanying band of weather is narrower, more severe, and usually of shorter duration than with warm fronts.

With slow-moving cold fronts and stable warm air, rain clouds of the stratus type form in a wide band over the frontal surface and extend for some distance behind the front. If the warm air is moist and conditionally unstable, thunderstorms may form, with the heaviest rainfall near the frontal zone and immediately following. If the warm air is fairly dry and the temperature contrast across the front is small, there may be little or no precipitation and few or no clouds.

With rapidly moving cold fronts, the weather is more severe and occupies a narrower band. The disturbance is also of shorter duration than that caused by a slow-moving front. If the warm air is relatively stable, overcast skies and precipitation may occur for some distance ahead of the front, and the heaviest precipitation may occur ahead of the surface cold front. If the warm air is moist and conditionally unstable, scattered showers and thunderstorms form just ahead of the cold front.

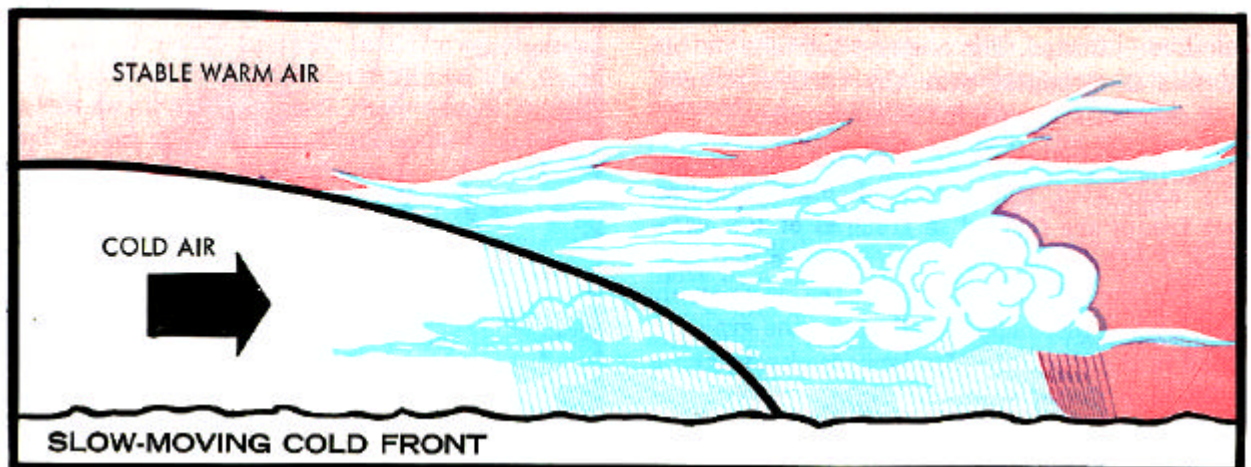

Clouds and precipitation cover a wide band and extend some distance behind slow-moving cold fronts. If the warm air is moist and stable, stratus-type clouds and steady rain occur, if the warm air is conditionally unstable, showers and thunderstorms are likely.

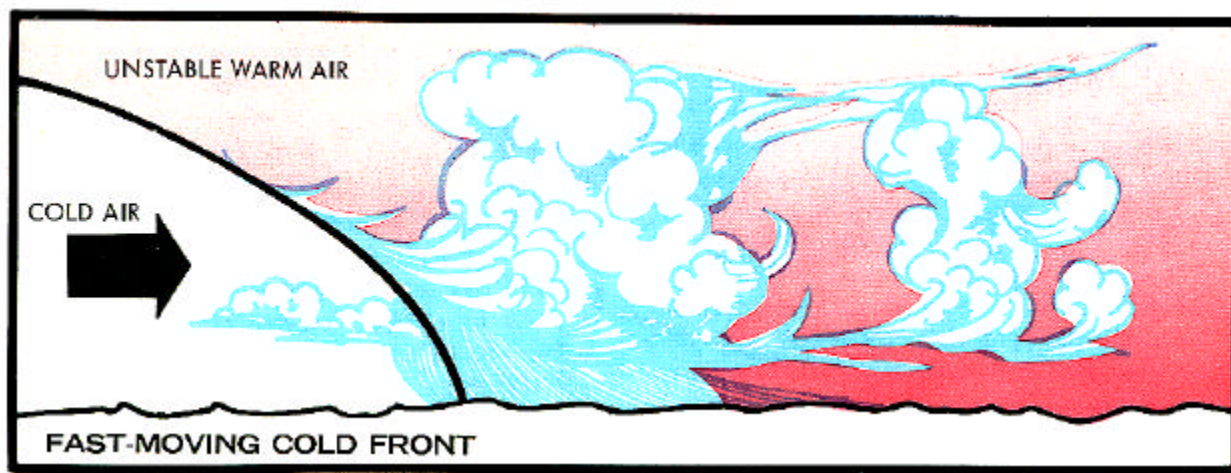

With rapidly moving cold fronts, the weather is more severe and occupies a narrower band. If the warm air is moist and conditionally unstable, as in this case, scattered showers and thunderstorms form just ahead of the cold front.

The weather usually clears rapidly behind a fast-moving cold front, with colder temperatures and gusty, turbulent surface winds following the frontal passage.

Under some conditions, a line of showers and thunderstorms is formed from 50 to 300 miles ahead of, and roughly parallel to, a cold front. This is called a squall line. The weather associated with squall lines is often more severe than that associated with the subsequent cold front. After the passage of the squall line, the temperature, wind, and pressure usually revert to conditions similar to those present before the squall line approached. Occasionally, the showers and thunderstorms are scattered along the squall line so that some areas experience strong, gusty winds without any precipitation.

Dry cold fronts often cause very severe fire weather in many sections. Dry cold-front passages may occur in any region, but they are a major problem in the Southeast. Cold fronts tend to be drier farther away from the low-pressure center with which they are associated. Thus, a cold front associated with a Low passing eastward across Southern Canada or the Northern States may be very dry as it passes through the Southeast. In addition, the polar air mass following the cold front may become quite unstable because of surface heating by the time it reaches the Southeast.

The combination of strong, gusty winds and dry, unstable air creates serious fire weather. The

second of two cold fronts passing through the Southeast in rapid succession also tends to be dry. The warm air mass ahead of the first cold front may be moist and produce precipitation, but the air mass between the first and second fronts usually will not have had time to acquire much moisture. Therefore, the second cold-front passage may be dry and will be the more serious from the fire-control standpoint.

The dry, trailing ends of cold fronts cause serious fire weather wherever they occur. Along the Pacific coast, the winds behind such cold fronts are, at times, from a northeasterly direction. This offshore direction means that the air flows from high elevations to low elevations and has foehn characteristics. The strong, shifting, gusty winds of the cold-front passage combine with the dry foehn wind to the rear of the front to produce a short-lived but extremely critical fire-weather condition.

Warm Fronts

The leading edge of an advancing warm air mass is called a warm front. The warm air is overtaking and replacing the cold air, but at the same time sliding up over the wedge of cold air. Warm fronts are flatter than cold fronts, having slopes ranging from 1/100 to 1/300. Because of this flatness, cloudiness and precipitation extend over a broad area ahead of the front, providing, of course, that there is sufficient moisture in the warm air.

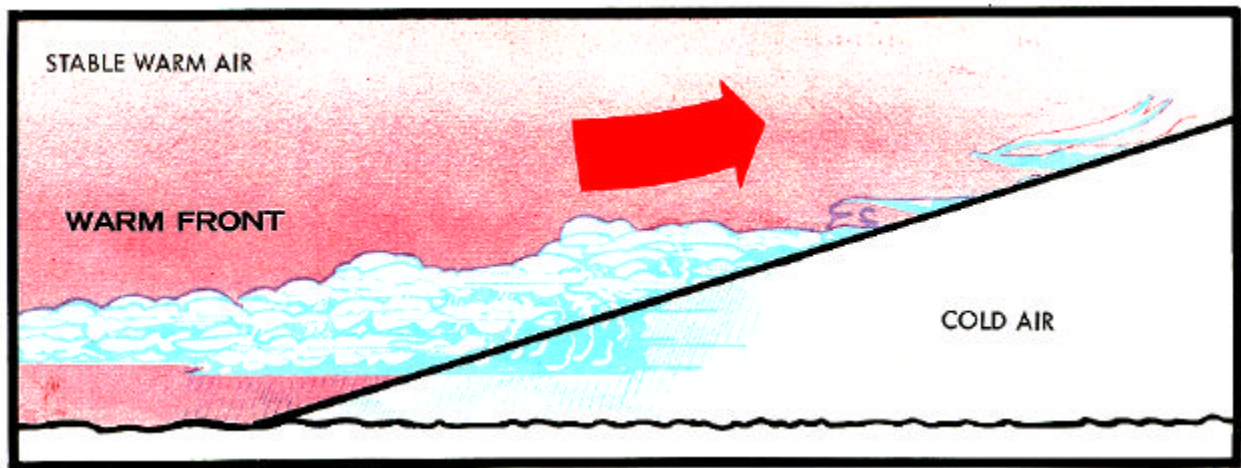

If the warm air above a warm front is moist and stable, clouds are of the stratus type. The sequence of cloud types is cirrus, cirrostratus, altostratus, and nimbostratus. Precipitation is steady and increases gradually with the approach of a front.

Warm fronts are less distinct than cold fronts and more difficult to locate on weather maps. This is particularly true in rough terrain where high-elevation areas may extend up into the warm air before the warm front has been felt at lower elevation stations.

The first indication of the approach of warm, moist air in the upper levels ahead of the surface warm front may be very high, thin, cirrostratus clouds which give the sky a milky appearance. These are followed by middle-level clouds which darken and thicken as precipitation begins. This sequence may be interrupted by short clearing

periods, but the appearance of successively lower cloud types indicates the steady approach of the warm front. Rains may precede the arrival of the surface warm front by as much as 300 miles. Rain falling through the cold air raises the humidity to the saturation level and causes the formation of low stratus clouds.

If the warm air above the warm front is moist and stable, the clouds which form are of the stratus type. The sequence is cirrus, cirrostratus, altostratus, and nimbostratus. Precipitation is a steady type and increases gradually with the approach of the surface front.

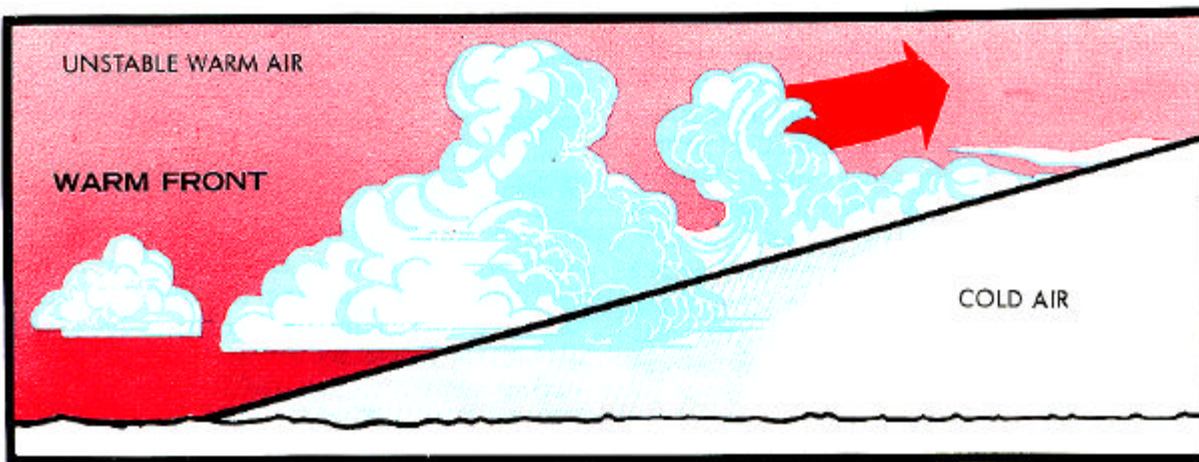

If the warm air above a warm front is moist and conditionally unstable, altocumulus and cumulonimbus clouds form. Often, thunderstorms will be embedded in the cloud masses.

If the warm air is moist and conditionally unstable, altocumulus and cumulonimbus clouds form, and, frequently, thunderstorms will be embedded in the cloud masses that normally accompany a warm front.

The rate of movement of warm fronts is about half that of cold fronts. Winds are usually not as strong or gusty with the approach of warm fronts as with cold fronts. The shift in wind is generally from an easterly to a southerly direction as a warm front passes. After it passes, temperatures rise, precipitation usually stops, and clouds diminish or vanish completely.

From the standpoint of fire weather, warm fronts associated with moist air are a real benefit. The accompanying precipitation is widespread and long-lasting, and usually is sufficient to thoroughly moisten forest fuels, reducing the fire danger.

Stationary Fronts

When the forces acting on two adjacent air

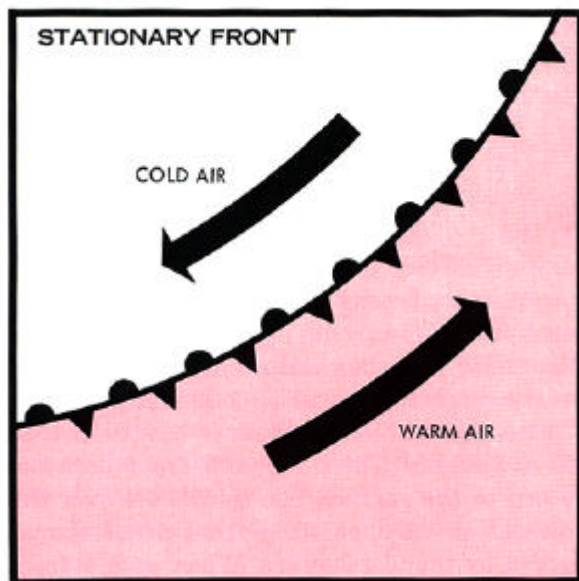

Surface winds on either side of a stationary front tend to blow parallel to the front, but in opposite directions. Stationary fronts are indicated on weather maps by alternate sharp cusps and semicircles on opposite sides of the front.

masses are such that the frontal zone shows little movement, the front is called a stationary front. Surface winds on either side of the front tend to blow parallel to the front, but in opposite directions. Weather conditions occurring with a stationary front are variable; usually they are similar to those found with a warm front, though less intense. If the air is dry, there may be little cloudiness or precipitation. If the air is moist, there may be continuous precipitation with stable, warm air, or showers and thunderstorms with conditionally unstable, warm air. The precipitation area is likely to be broader than that associated with a cold front, but not as extensive as with a warm front.

Stationary fronts may quickly change back to moving fronts as a slight imbalance of forces acting on the air masses develops. A stationary front may oscillate back and forth, causing changing winds and weather conditions at a given location. It may become a cold or warm front, or a frontal wave may develop, as we will see in the next section.

Frontal Waves and Occlusions

A frontal surface is similar to a water surface. A disturbance such as wind can cause the formation of waves on the water. If the wave moves toward the shoreline, it grows until it becomes topheavy and breaks. Similarly, along frontal surfaces in the atmosphere a disturbance may form a wave. This disturbance may be a topographic irregularity, the influence of an upper-level trough, or a change in the wind field caused by local convection. Waves usually form on stationary fronts or slow-moving cold fronts, where winds on the two sides of the front are blowing parallel to the front with a strong shearing motion.

When a section of a front is disturbed, the warm air begins to flow up over and displace some of the cold air. Cold air to the rear of the disturbance displaces some of the warm air. Thus, one section of the front begins to act like a warm front, and the adjacent section like a cold front. This deformation is called a frontal wave.

The pressure at the peak of the frontal wave falls, and a low-pressure center with

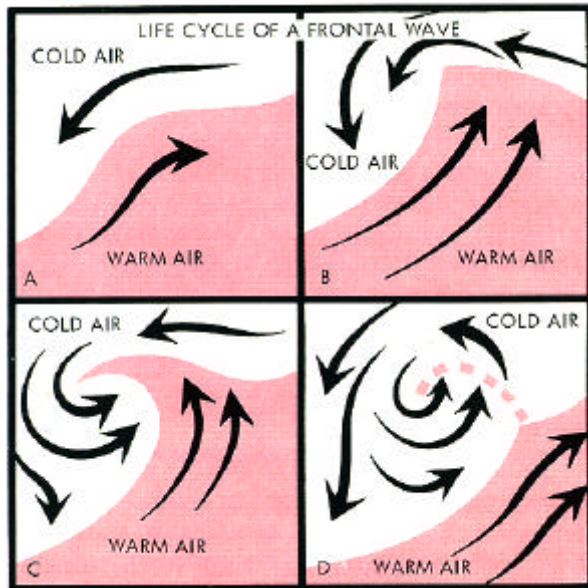

The life cycle of a frontal wave includes the following steps: A. A disturbed section of a front. B. Cold air begins to displace warm air to the rear of the disturbance, and warm air ahead tends to override the cold air. The front ahead of the disturbance becomes a warm front, and the portion to the rear becomes a cold front. C. A cyclonic circulation is established and pressure falls at the crest of the wave. D. After the cold front overtakes the warm front, an **occlusion** is formed and the system enters its dying phases.

a counterclockwise (cyclonic) circulation is formed. If the pressure continues to fall, the wave may develop into a major cyclonic system. The Low and its frontal wave generally move in the direction of the wind flow in the warm air, which is usually toward the east or northeast.

As the system moves, the cold front moves faster than the warm front and eventually overtakes the warm front. The warm air is forced aloft between the cold air behind the cold front and the retreating cold air ahead of the warm front. The resulting combined front is called an occlusion or occluded front. This is the time of maximum intensity of the wave cyclone. The pressure becomes quite low in the occluded system with strong winds around the Low. Usually the system is accompanied by widespread cloudiness and precipitation. The heaviest precipitation occurs to the north of the low-pressure center.

As the occlusion continues to grow in length, the cyclonic circulation diminishes in intensity, the low-pressure center begins to fill, and the frontal movement slows down.

There are two types of occluded fronts—a warm-front type and a cold-front type—depending on whether the surface air ahead of the occlusion is warmer or colder than the air to the rear.

The cold-front type is predominant over most of the continent, especially the central and eastern regions. The weather and winds with the passage of a cold-front occlusion are similar to those with a cold front. Ahead of the occlusion, the weather and cloud sequence is much like that associated with warm fronts.

Most warm-front occlusions are found along the west coast. The air mass to the rear is warmer than the air mass ahead. Therefore, when the cold front overtakes the warm front, it rides up the warm-front surface and becomes an **upper cold front**.

The weather associated with a warm-front occlusion has characteristics of both warm-front and cold-front weather. The sequence of clouds and weather ahead of the occlusion is similar to that of a warm front. Cold-front weather occurs near the upper cold front. With moist and conditionally unstable air, thunderstorms may occur. At the surface, the passage of a warm-front occlusion is much like that of a warm front. The rainy season in the Pacific Northwest, British Columbia, and southeastern Alaska is dominated by a succession of warm-front occlusions that move in from the Pacific.

Another type of upper cold front should be mentioned. Cold fronts approaching the Rocky Mountains from the west are forced to rise and cross over the mountains. Quite frequently in winter, a very cold air mass is located east of the mountains. Then, the cold front does not return to the surface, but rides aloft over the cold air as an upper cold front often accompanied by thundershowers. When such a front meets an mT air mass, and underrides it, a very unstable condition is produced that will result in numerous thunderstorms and, occasionally, tornadoes.

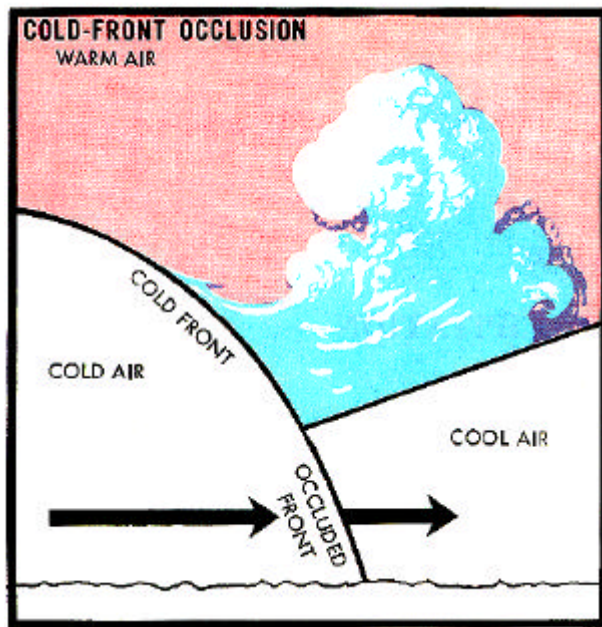

A cross section through a cold-front occlusion shows the warm air having been lifted above the two colder air masses. At the surface, cold air is displacing cool air. The weather and winds associated with the frontal passage are similar to those with a cold front.

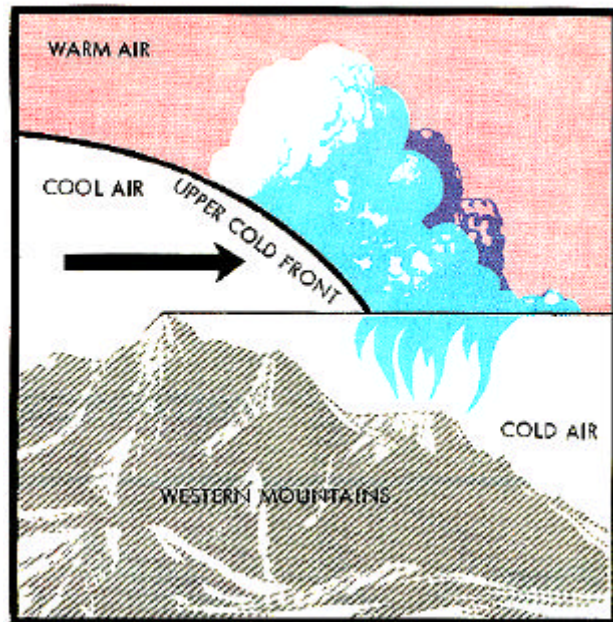

Cold fronts crossing the Rocky Mountains from the west are forced to rise over the mountains. Quite frequently in winter, a very cold air mass is located east of the mountains. The cold front then does not return to the surface, but rides aloft over the cold air as an upper cold front. The frontal activity takes place above the cold air.

SUMMARY

When air stagnates in a region where surface characteristics are uniform, it acquires those characteristics and becomes an air mass. Warm, moist air masses are formed over tropical waters; cold, moist air masses over the northern oceans; cold, dry air masses over the northern continent; and warm, dry air masses over arid regions.

Air masses have characteristic weather in their source regions. But, as air masses leave their source regions, they are modified according to the surface over which they travel, and the air-mass weather changes.

In frontal zones, where differing air masses meet, considerable weather is concentrated.

Cloudiness, precipitation, and strong and shifting winds are characteristic of frontal passages; but, occasionally, frontal passages are dry and adversely affect fire behavior.

In discussing many of the topics so far, it has been necessary to mention different types of clouds from time to time. Different cloud types are associated with stability and instability, and certain cloud sequences are characteristic of different frontal systems. In the following chapter, we will discuss types of clouds more fully and examine the precipitation processes that develop in clouds.

Chapter 9

LOUDS AND PRECIPITATION

Fire weather is usually fair weather. Clouds, fog, and precipitation do not predominate during the fire season. The appearance of clouds during the fire season may have good portent or bad. Overcast skies shade the surface and thus temper forest flammability. This is good from the wildfire standpoint, but may preclude the use of prescribed fire for useful purposes. Some clouds develop into full-blown thunderstorms with fire-starting potential and often disastrous effects on fire behavior.

The amount of precipitation and its seasonal distribution are important factors in controlling the beginning, ending, and severity of local fire seasons. Prolonged periods with lack of clouds and precipitation set the stage for severe burning conditions by increasing the availability of dead fuel and depleting soil moisture necessary for the normal physiological functions of living plants. Severe burning conditions are not erased easily. Extremely dry forest fuels may undergo superficial moistening by rain in the forenoon, but may dry out quickly and become flammable again during the afternoon.

CLOUDS AND PRECIPITATION

Clouds consist of minute water droplets, ice crystals, or a mixture of the two in sufficient quantities to make the mass discernible. Some clouds are pretty, others are dull, and some are foreboding. But we need to look beyond these aesthetic qualities. Clouds are visible evidence of atmospheric moisture and atmospheric motion. Those that indicate instability may serve as a warning to the fire-control man. Some produce precipitation and become an ally to the firefighter. We must look into the processes by which clouds are formed and precipitation is produced in order to understand the meaning and portent of clouds as they relate to fire weather. We will see how clouds are classified and named, and what kinds of precipitation certain types of clouds produce.

The total amount of water vapor in the atmosphere is very large. It has been estimated that the amount carried across the land by air currents is more than six times the amount of water carried by all our rivers. One inch of rainfall over an acre weighs about 113 tons. Over an area the size of Oregon, 1 inch of rain is equivalent to nearly 8 billion tons of water. All of this water comes from condensation of vapor in the atmosphere. For each ton of water that condenses, almost 2 million B.t.u.'s of latent heat is released to the atmosphere. It becomes obvious that tremendous quantities of water and energy are involved in the formation of clouds and precipitation.



The total amount of water vapor that flows across the land on air currents originating over water is estimated to be more than six times the water carried by all our rivers.

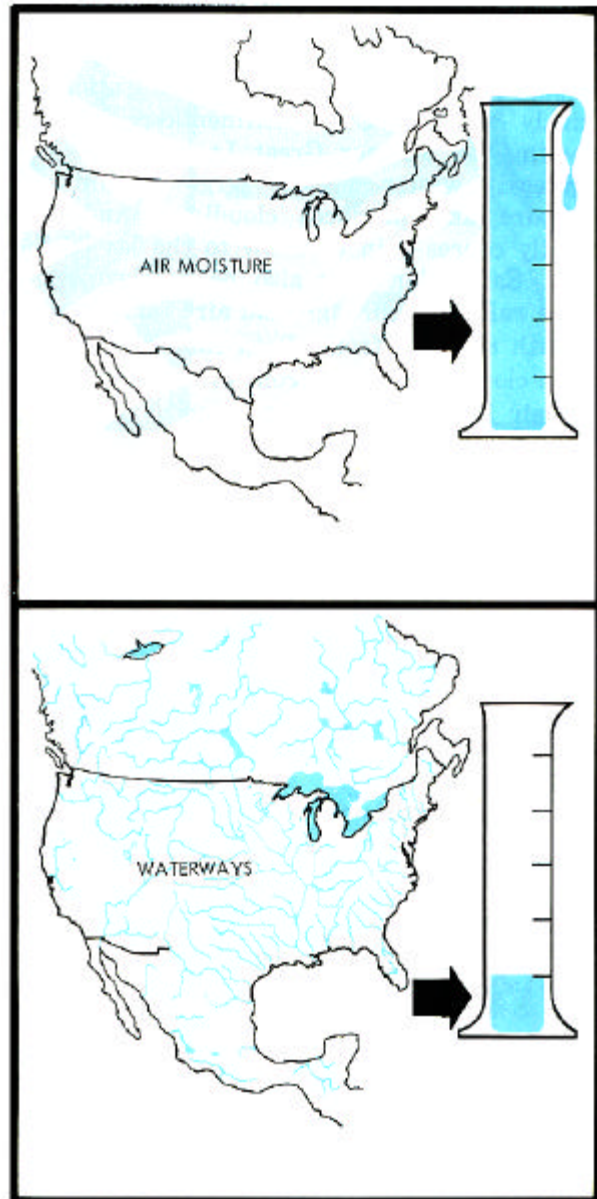

In order for clouds to form and precipitation to develop, the atmosphere must be saturated with moisture. In chapter 3 we learned that at saturation the atmospheric vapor pressure is equal to the saturation vapor pressure at the existing temperature and pressure. There are two principal ways in which the atmospheric vapor pressure and saturation vapor pressure attain the same value to produce 100 percent relative humidity, or saturation. These are through the addition of moisture to the air, or, more importantly, through the lowering of air temperature.

As cold air passes over warm water, rapid evaporation takes place, and saturation is quickly reached. Cold continental polar air crossing the warmer Great Lakes in the fall and early winter gathers large amounts of moisture and produces cloudiness and frequently causes rain or snow to the lee of the lakes. Saturation may also be reached when warm rain falls through cold air; for example, beneath a warm front. Rain falling from the warm clouds above the front evaporates in the cold air beneath and forms scud clouds. Contrails

made by high-flying aircraft are a type of cloud formed by the addition of moisture from the plane's exhaust.

The more important method of reaching saturation, by lowering air temperature, is accomplished in several ways. Warm, moist air may be cooled to its dew point by passing over a cold surface. The cooling takes place near the surface so that, with light wind conditions, fog is formed. If the winds are strong, however, they will cause mixing of the cooled air, and clouds will form several hundred or even a thousand or more feet above the surface.

Lifting of air, and the resultant adiabatic expansion, is the most important cooling method. The lifting may be accomplished by thermal, orographic, or frontal action. It produces most of the clouds and precipitation.

Local heating will result in thermal lifting. As heated surface air becomes buoyant, it is forced aloft and cools. The air cools at the dry-adiabatic rate of 5.5°F. per thousand feet, while the dew point lowers only about 1°F. per thousand feet, reflecting the decreasing absolute humidity with expansion. Thus the temperature

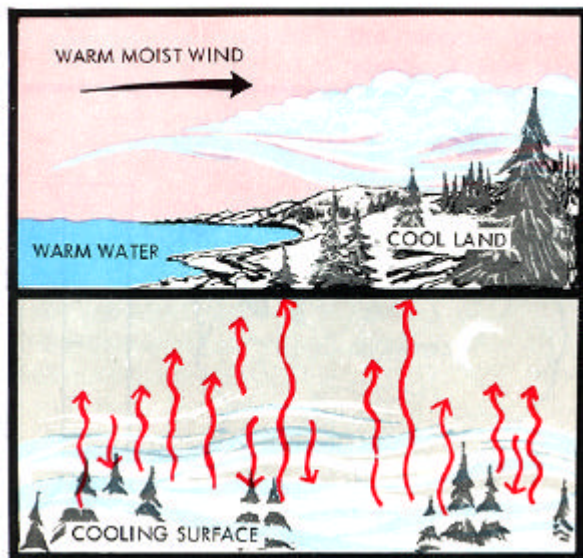

Moist air may be cooled to its dew point and become saturated as it passes over cool and or water surfaces. Nighttime cooling of the ground surface by radiation, and the subsequent cooling of adjacent moist air, may produce saturation and fog.

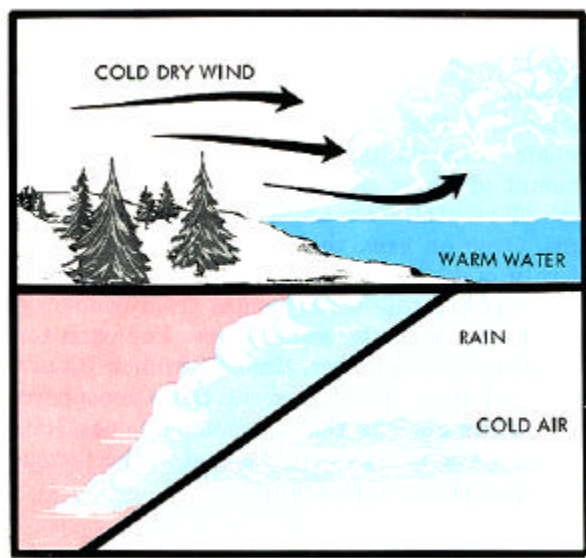

Air can become saturated by the addition of moisture. This may occur by evaporation as cold, dry air passes over warm water, or as warm rain from above a front falls through cold air beneath the front.

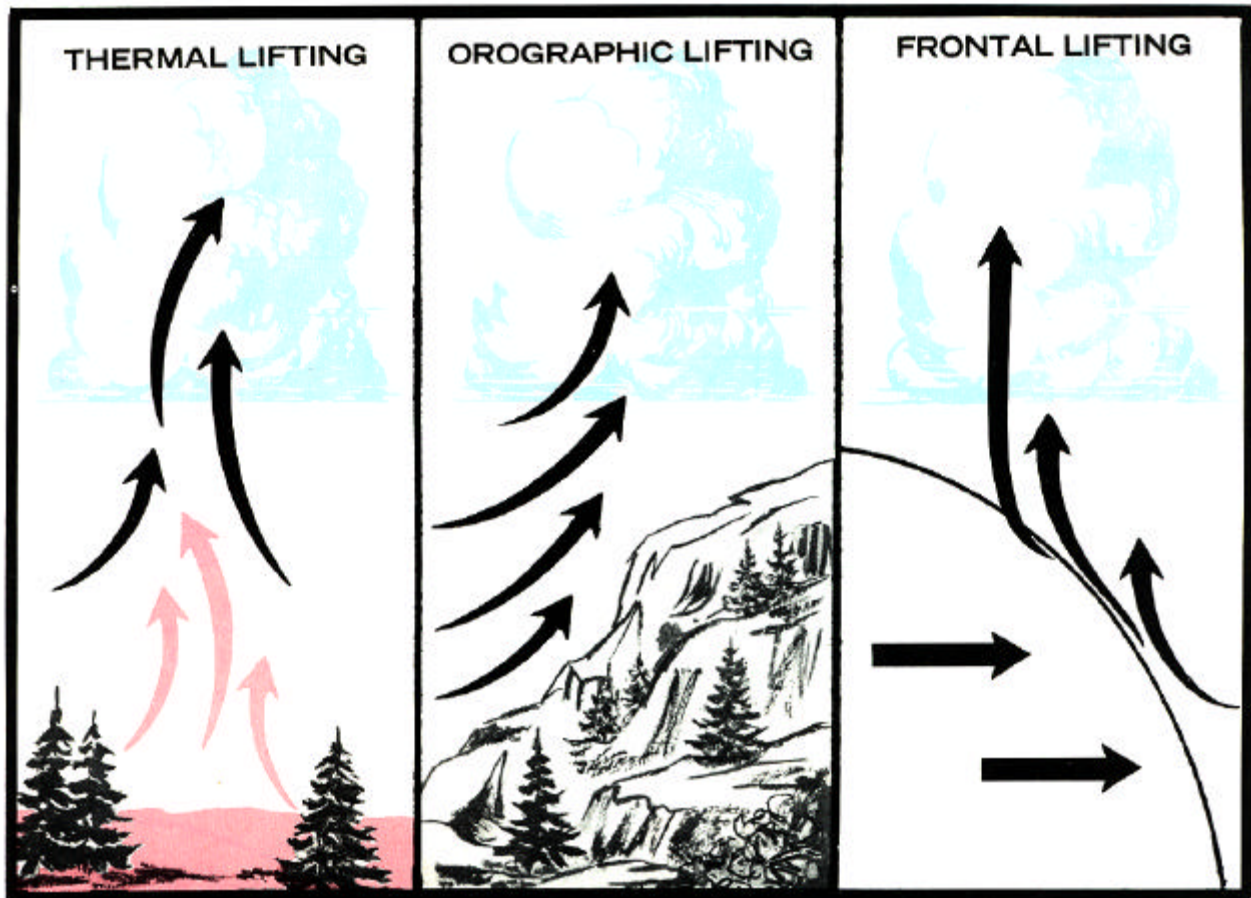

The most important method of cooling air to saturation is adiabatic cooling because of lifting. Lifting may be thermal, orographic, or frontal.

and dew point approach each other at the rate of 4.5°F. per thousand feet. If the locally heated air contains enough moisture and rises far enough, saturation will be reached and cumulus clouds will form. In fact, a common method of estimating the base of cumulus clouds formed, usually in the summer months, by thermal convection in the lower layers is to divide the difference between the surface air temperature and dew point by 4.5. This gives the approximate height of the cloud base in thousands of feet.

As an example, suppose we begin with heated air at the surface having a temperature of 84°F., wet-bulb temperature of 71°F., dew-point temperature of 66° F., and a relative humidity of 54 percent. If the air rose to an altitude of 4,000 feet,

the dry-bulb, wet-bulb, and dew-point temperatures would all have decreased to 62°F. Saturation would have been reached as the humidity would be 100 percent. Continued rising would produce condensation and visible clouds.

Thermal lifting is most pronounced in the warm seasons. It may turn morning stratus clouds into stratocumulus with the possibility of light showers. More frequently, depending on stability, continued heating develops cumuli-form clouds that result in heavier showers and thunderstorms. Rainfall associated with thermal lifting is likely to be scattered in geographic extent. In flat country, the greatest convective activity is over the hottest surfaces. In mountain country, it is greatest over the highest peaks and ridges.

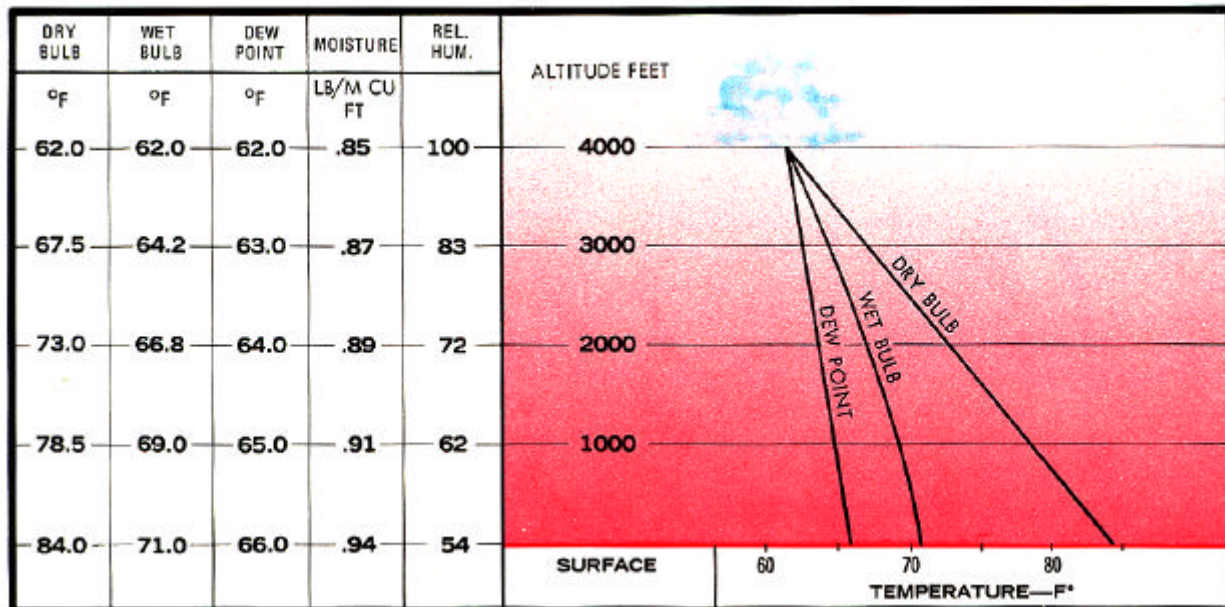

If the temperature at the surface of a thermally lifted parcel of air was 84°F., the wet-bulb 71°F., and the dew point 66°F., saturation would be reached at 4,000 feet above the surface.



Lifting of moist air over mountain ranges is an important process in producing clouds and precipitation. In the West the winter precipitation is heaviest on the western slopes of the Coast Ranges, Sierra-Cascades, and Rocky Mountains. Lowlands to east of the ranges are comparatively dry.

Orographic lifting, in which air is forced up the windward side of slopes, hills, and mountain ranges, is an important process in producing clouds and precipitation. As in thermal lifting, the air is cooled by the adiabatic process.

In the West, maritime polar air flowing in from the Pacific Ocean produces winter clouds and precipitation as it is lifted over the mountain ranges. The Coast Ranges, Sierra-Cascades, and Rocky Mountains are the principal mountain

systems involved. Lifting in each case occurs on the western slopes, and it is these that receive the heaviest precipitation. The lee slopes and adjacent valleys and plains receive progressively less as the air moves eastward.

Similarly in the East, maritime tropical air that has moved into the central portion of the United States and Southern Canada is lifted and produces precipitation in the Appalachian

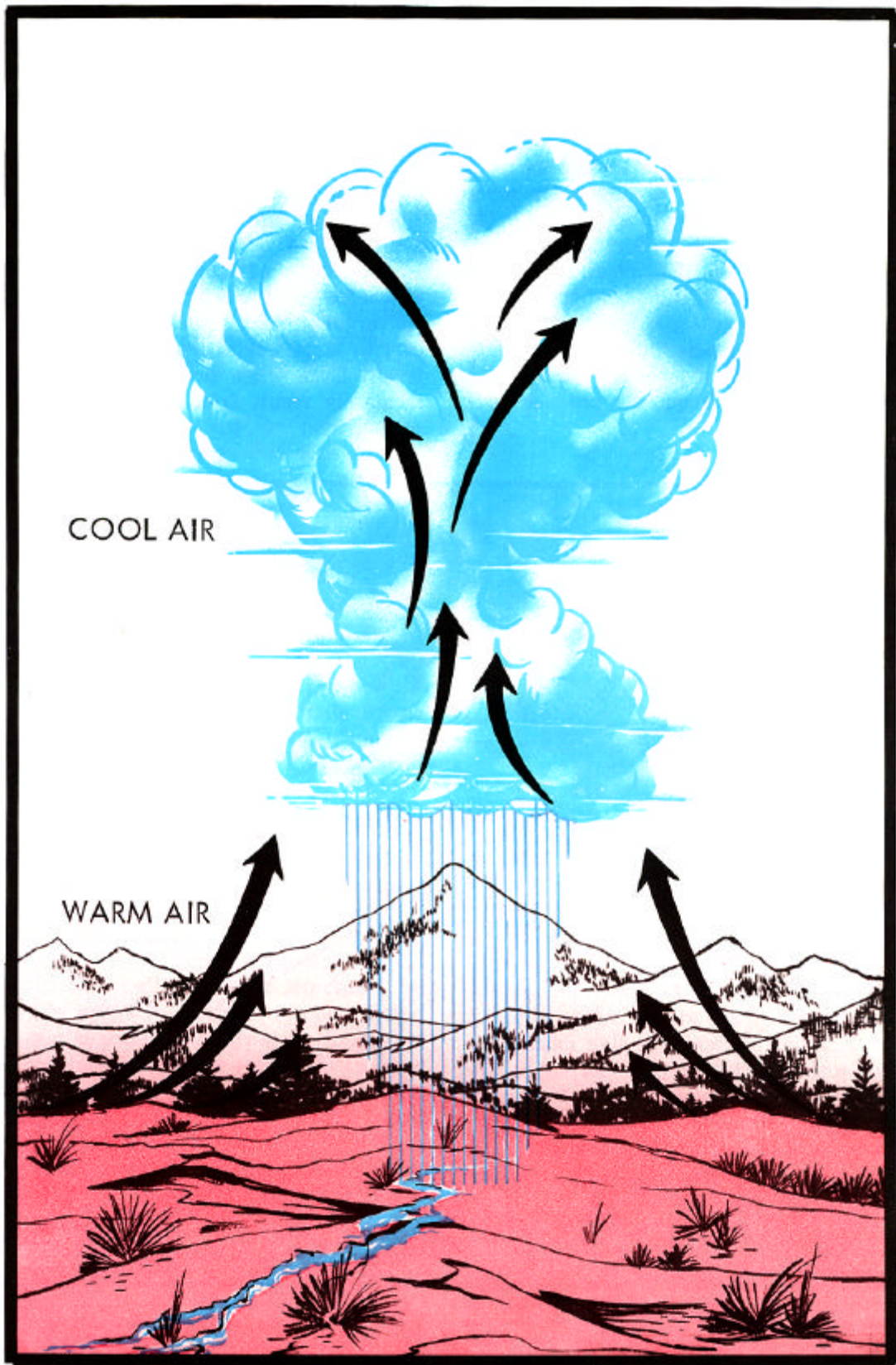

Thermal lifting usually produces cumulus clouds. Continued heating in moist air will result in showers and possibly thunderstorms.

Mountains as it progresses eastward. Other air masses, such as continental polar and maritime polar, will also cause precipitation in these mountains if they have acquired sufficient moisture before being lifted.

Frontal lifting, as air is forced up the slope of warm or cold fronts, accounts for much cloudiness and precipitation in all regions in the winter and in many regions during all seasons of the year. East of the Rockies and along the west coast, warm fronts, because of the gradual slope of their frontal surfaces, typically produce steady rains over extensive areas. Cold fronts, with characteristically steeper and faster moving leading surfaces, frequently produce more

intense rainfall from cumulonimbus clouds along the front or along a squall line ahead of the front. This rainfall, however, is usually more scattered and of a shorter duration than that produced by a warm front.

Convergence is another important method of lifting which produces clouds and precipitation. During convergence, more air moves horizontally into an area that moves out. The excess is forced upward. Since moisture is concentrated in the lower atmospheric levels, convergence, like other lifting mechanisms, carries large quantities of moisture to higher levels. Even when precipitation does not immediately result from this cause, subsequent

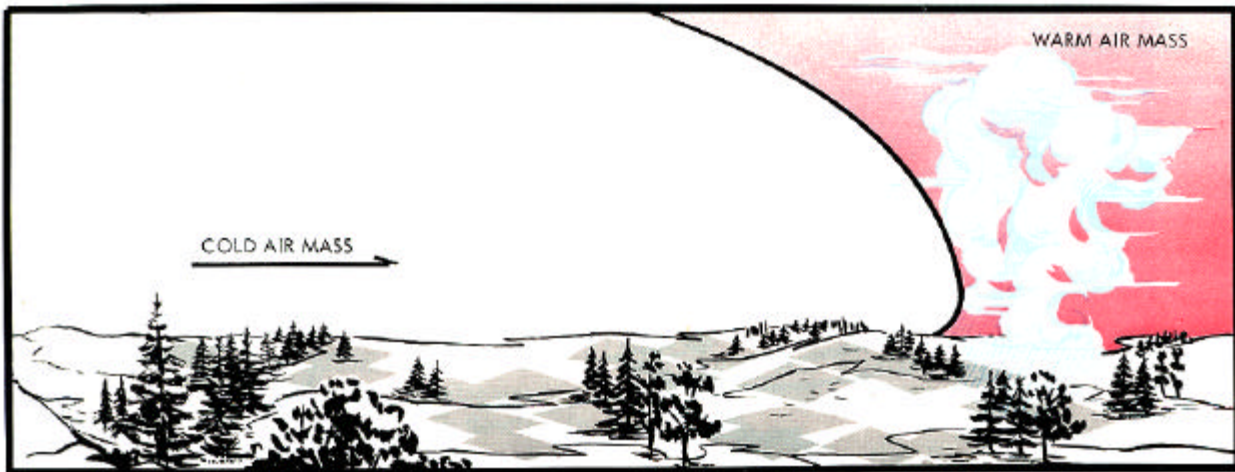
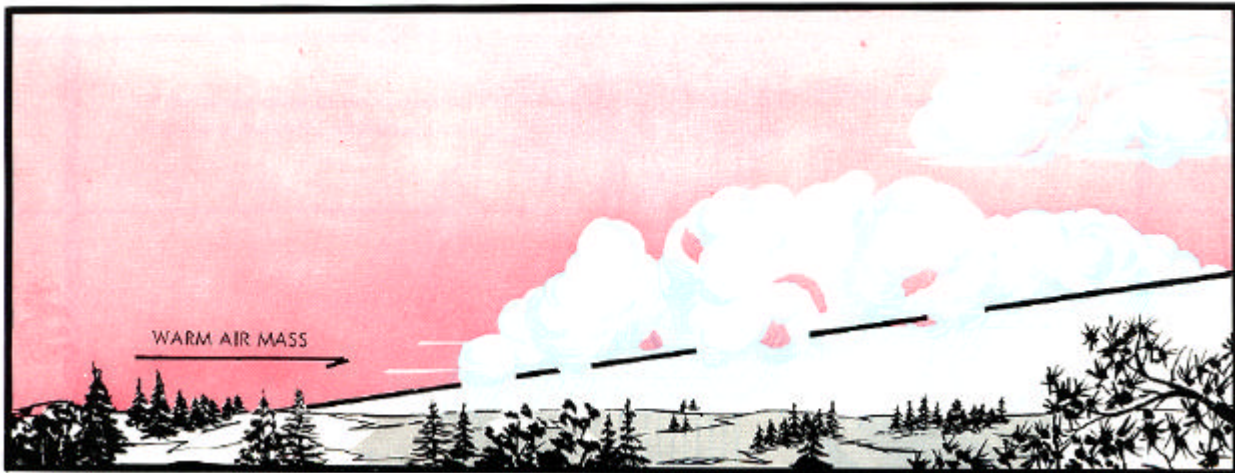

Top. - Lifting of warm, moist air, as it is forced up the slope of a warm front, produces widespread cloudiness and precipitation.

Bottom—The steepness and speed of cold fronts result in a narrow band of cloudiness and precipitation as warm, moist air ahead of the front is lifted.

precipitation triggered by other processes may be much more intense than if convergence had not occurred.

As we discussed in chapter 5, the circulation around a low-pressure system results in convergence. Here, friction deflects the flow toward the center. With more air flowing toward the center than away from it, there is a corresponding upward flow of air. For this reason, low-pressure areas are usually areas of cloudiness and precipitation. On a small scale, convergence occurs during the daytime over mountain peaks and ridges as thermal up-slope winds from opposing sides meet at the top.

We have discussed various methods by which air becomes saturated and condensation and precipitation are produced, but we must remember that in most cases two or more of these methods are acting at the same time. Daytime cumulus clouds over mountains may be produced by heating, orographic lifting, and the convergence of thermal winds all acting together. Nighttime fog and drizzle in maritime tropical (mT) air that moves from the Gulf of Mexico into the Plains regions may be the result of a combination of orographic lifting and nighttime cooling. Frontal lifting may be

assisted by orographic lifting in mountain areas, or by convergence in low-pressure areas and troughs.

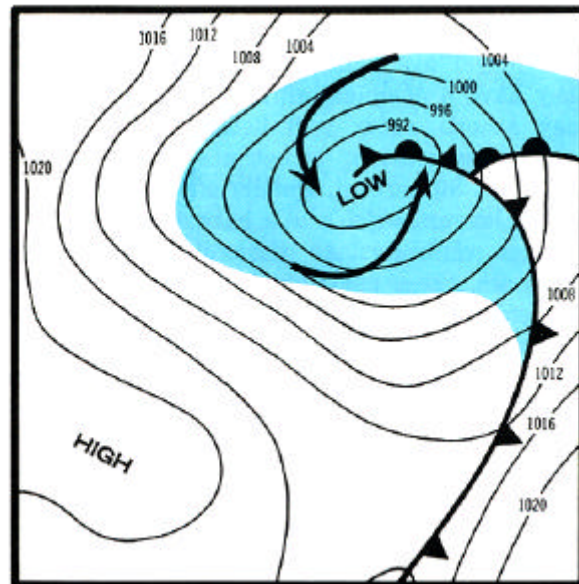

The circulation around a low-pressure area causes horizontal converging of air at low levels and lifting of air near the center. For this reason, low-pressure areas usually are areas of cloudiness and precipitation. Frontal lifting is frequently combined with convergence.

CONDENSATION, SUBLIMATION, AND PRECIPITATION PROCESSES

We discussed earlier in chapters 1 and 3 some of the aspects of condensation and sublimation. We were concerned with the change of state of water from gaseous to liquid or solid forms, and we used for simple examples the impaction of water vapor molecules on a liquid or solid surface. Dew and frost do form that way, but cloud particles are formed in the free atmosphere, and here the process becomes more complicated. Still more complex are the processes of precipitation where cloud particles must grow to a large enough size to fall out by gravity.

We are all familiar with condensation and sublimation. We have noticed the condensation of our breath on cold days, and of steam rising from boiling water. We have seen dew formed on grass at night, or on cold water pipes and cold glasses, and have noticed the sublimation

of water vapor into frost on cold window panes in winter.

For condensation or sublimation to occur in the free air, a particle or nucleus must be present for water-vapor molecules to cling to. These fine particles are of two types: condensation nuclei and sublimation nuclei. Condensation nuclei, on which liquid cloud droplets form, consist of salt particles, droplets of sulfuric acid, and combustion products. They are usually abundant in the atmosphere so that cloud droplets form when saturation is reached. Sublimation nuclei, on which ice crystals form, consist of dust, volcanic ash, and other crystalline materials. Because of differences in composition and structure, different nuclei are effective at different below-freezing temperatures. As the temperature decreases, additional nuclei become active in the sublimation process. These

nuclei are not as plentiful as condensation nuclei. Even at temperatures well below freezing, there frequently are too few effective nuclei to initiate more than a scattering of ice crystals.

The small particles that act as condensation nuclei are usually hygroscopic; that is, they have a chemical affinity for water. They may absorb water well before the humidity reaches saturation, sometimes at humidities as low as 80 percent. Condensation forms first on the larger nuclei, and a haze develops which reduces visibility. As the relative humidity increases, these particles take on more water and grow in size while condensation also begins on smaller nuclei. Near saturation, the particles have become large enough to be classed as fog or cloud droplets, averaging 1/2500—inch in diameter, and dense enough so that the mass becomes visible. Rapid cooling of the air, such as in strong upward currents, can produce humidities of over 100 percent—supersaturation—temporarily. Under such conditions droplets grow rapidly, very small nuclei become active and start to grow, and many thousands of droplets per cubic inch will form. With supersaturation even nonhygroscopic particles will serve as condensation nuclei, but usually there are sufficient hygroscopic nuclei so that the others do not have a chance.

As condensation proceeds, droplets continue to grow until they reach a maximum size of about 1/100 inch in diameter, the size of small drizzle drops. The condensation process is unable to produce larger droplets for several reasons. As vapor is used up in droplet formation, supersaturation decreases and the cloud approaches an equilibrium state at saturation. Also, as droplets grow, the mass of water vapor changing to liquid becomes large and the resultant latent heat released in the condensation process warms the droplet and decreases the vapor pressure difference between it and the surrounding vapor. Thus the vast majority of clouds do not produce rain. If growth to raindrop size is to take place, one or more of the precipitation processes must come into play. We will discuss these later.

An important phenomenon in the physics of condensation and precipitation is that liquid cloud droplets form and persist at temperatures

well below freezing. Although ice melts at 32°F., water can be cooled much below this before it changes to ice. Liquid cloud droplets can exist at temperatures as low as —40°F. More commonly in the atmosphere though, cloud droplets remain liquid down to about 15°F. Liquid droplets below 32°F. are said to be supercooled. At temperatures above 32°F., clouds are composed only of liquid droplets. At temperatures much below 15°F. they are usually composed mostly of ice crystals, while at intermediate temperatures they may be made up of supercooled droplets, ice crystals, or both.

Why don't ice crystals form more readily? First, the formation of ice crystals at temperatures higher than —40°F. requires sublimation nuclei. As was mentioned above, these usually are scarce in the atmosphere, especially at higher elevations. Also, many types of nuclei are effective only at temperatures considerably below freezing. But another reason why vapor condenses into liquid droplets, rather than sub-limes into ice crystals, is that condensation can begin at relative humidities well under 100 percent while sublimation requires at least saturation conditions and usually supersaturation.

Given the necessary conditions of below-freezing temperature, effective sublimation nuclei, and supersaturation, sublimation starts by direct transfer of water vapor to the solid phase on a sublimation nucleus. There is no haze phase as in the case of condensation. Once sublimation starts, ice crystals will grow freely under conditions of supersaturation. Since there are fewer sublimation than condensation nuclei available, the ice crystals that form grow to a greater size than water droplets and can fall from the base of the cloud.

Only very light snow, or rain if the crystals melt, can be produced by sublimation alone. Moderate or heavy precipitation requires one of the precipitation processes in addition to sublimation.

After condensation or sublimation processes have gone as far as they can, some additional process is necessary for droplets or crystals to grow to a size large enough to fall freely from the cloud and reach the ground as snow or rain. Cloud droplets, because of their small size and consequent slight pull of gravity,

have a negligible rate of fall, and for all practical purposes are suspended in the air. Even drizzle droplets seem to float in the air. Raindrops range in size from about 1/50 inch to 1/5 inch in diameter. Drops larger than 1/5 inch tend to break up when they fall. It takes about 30 million cloud droplets of average size to make one raindrop about 1/8 inch in diameter.

There seem to be two processes which act together or separately to cause millions of cloud droplets to grow into a raindrop. One is the ice-crystal process and the other is the coalescence process.

The Ice-Crystal Process

We have seen that ice crystals and cloud droplets can coexist in clouds with subfreezing temperatures. For the ice-crystal process of precipitation to take place, clouds must be composed of both ice crystals and supercooled liquid cloud droplets.

In chapter 3 we discussed vapor pressure and saturation vapor pressure at some length, but we considered only saturation vapor pressure with respect to liquid water. The saturation vapor pressure with respect to ice is somewhat less than that with respect to super-cooled water at the same temperature, as shown in the following table:

Comparative Saturation Vapor Pressures Over Water and Ice

Temperature (°F.)	Saturation vapor pressure	Relative humidity over ice
	Over water (Inches of mercury)	Over ice (Percent)
0	0.045	119
10	.071	112
20	.110	106
30	.166	101

If a cloud containing supercooled water droplets is saturated with respect to water, then it is supersaturated with respect to ice, and the relative humidity with respect to ice is greater than 100 percent. The force resulting from the difference between vapor pressure over water and over ice causes vapor molecules to be attracted to ice crystals, and the ice crystals will grow rapidly. As the ice crystals gather up vapor molecules in the cloud, the relative humidity with respect to water drops

below 100 percent, and liquid cloud droplets begin to evaporate. Vapor molecules move to the ice crystals and crystallize there. Thus, the ice crystals grow at the expense of the water droplets and may attain a size large enough to fall out of the cloud as snowflakes. If the snowflakes reach warmer levels, they melt and become raindrops, This is the ice-crystal precipitation process.

Artificial Nucleation

The knowledge that frequently there is a scarcity of sublimation nuclei and ice crystals in supercooled clouds has led to the discovery that precipitation can be initiated artificially. It has been found that silver-iodide crystals, which have a structure similar to ice crystals, can be effective sublimation nuclei in super-cooled clouds at temperatures below about 20°F. Silver-iodide crystals can be released in the cloud by aircraft or rockets, or carried to the cloud by convection from ground generators.

Ice crystals can be created in a supercooled cloud by dropping pellets of dry ice, solid carbon dioxide, into the cloud from above. The dry ice, which has a melting temperature of -108°F., cools droplets along its path to temperature

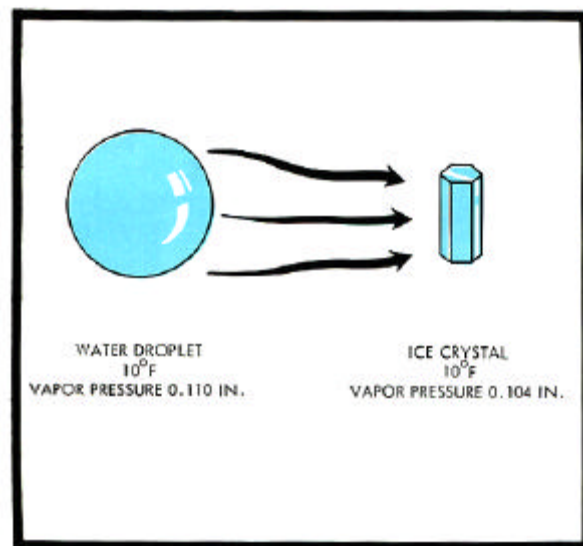

In the ice-crystal precipitation process, ice crystals grow at the expense of water droplets. Because of the difference in vapor pressure over ice and over water at the same temperature, a vapor-pressure gradient exists between supercooled water droplets and ice crystals in mixed clouds. Vapor molecules leave the water droplets and sublime on the ice crystals.

lower than -40°F . so that they can freeze into ice crystals without the presence of sublimation nuclei. Once crystals are produced, they act as nucleating particles themselves and affect other parts of the cloud.

Once formed in a supercooled water cloud, ice crystals may grow by the ice-crystal process and coalescence processes until they are large enough to precipitate. Studies have provided evidence that the artificial nucleation of super-cooled clouds can, under the proper conditions, increase local precipitation significantly.

Coalescence

Since rain also falls from clouds which are entirely above freezing, there must be a second precipitation process. This is a simple process in which cloud droplets collide and fuse together, or coalesce. Clouds which produce precipitation are composed of cloud droplets of varying sizes. Because of the different sizes, cloud droplets move about at different speeds. As they collide, some of them stick together to form larger drops. The larger cloud droplets grow at the expense of smaller ones, and actually become more effective in the collecting process as they become larger. As larger drops begin to fall, they tend to sweep out the smaller drops ahead of them.

The coalescence process takes place in clouds of

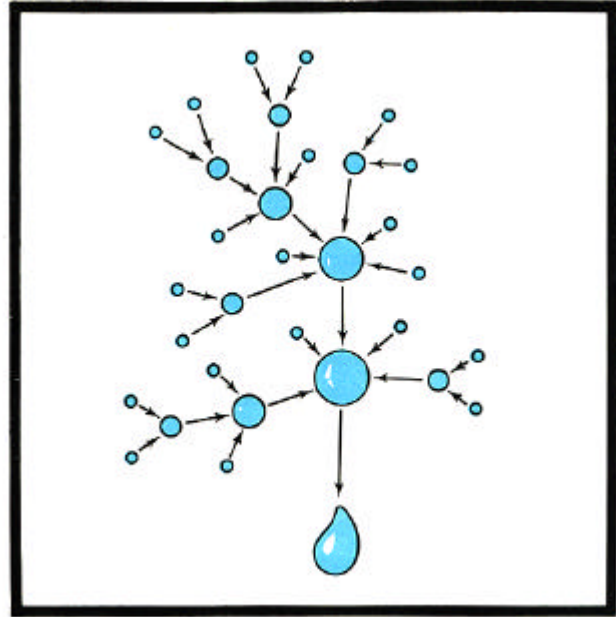

In the coalescence process of precipitation, small droplets collide and fuse together to become larger droplets. The process continues until enough droplets are accumulated into large drops so that the large drops fall because of gravity. Snowflakes coalesce into snowflake masses in a similar manner.

both above-freezing and below-freezing temperatures. Snowflakes coalesce with other snowflakes as they fall to form the large clumps which we sometimes observe. They may also coalesce with supercooled water droplets to form snow pellets.

KINDS OF CLOUDS

In order to recognize and identify clouds it is necessary to classify and name them. Clouds are identified by their development, content and appearance, and their altitude. They are classified into many types and subtypes, but we need be concerned only with the more basic types. We will consider four families of clouds distinguished by their height of occurrence:

High clouds, middle clouds, low clouds, and clouds with vertical development.

Within the first three families are two main subdivisions:

1. Clouds formed by localized vertical currents which carry moist air upward beyond the condensation level. These are known as cumuli-form clouds and have a billowy or heaped-up appearance.

2. Clouds formed by the lifting of entire layers of air, without strong, local vertical currents, until condensation is reached. These clouds are spread out in layers or sheets and are called stratiform.

In addition, the word nimbus is used as a prefix or suffix to indicate clouds producing precipitation—resulting in such names as nimbostratus or cumulonimbus. The word fractus is used to identify clouds broken into fragments by strong winds—such as stratus fractus and cumulus fractus.

Air stability has an important effect on the type of cloud formation. A stable layer which remains stable through forced lifting will develop stratiform clouds. Cumuliform clouds develop in air that is initially unstable or becomes

unstable when it is lifted. A layer of conditionally unstable air which is forced to ascend may first develop stratiform clouds and then develop cumuliform clouds as the layer becomes unstable. The cumuliform clouds project upward from a stratiform cloud layer. Thus, the type of cloud formation can be used as an indicator of the stability of the atmospheric layer in which the clouds are formed.

High Clouds

High clouds have bases ranging from 16,500 to 45,000 feet. Cirrus, cirrocumulus, and cirrostratus clouds are included in this family. They are usually composed entirely of ice crystals, and this is their most distinguishing characteristic.

Cirrus are isolated wisps of thin, feathery cloud up near the top of the troposphere. They are sometimes called “mares’ tails” and may have trailing streams of larger ice crystals beneath them.

Cirrocumulus clouds consist of patches of small, white cloud elements. They may form definite patterns at times, showing small but firm waves or ripples. They are sometimes referred to as “mackerel sky.” True cirrocumulus are rare and are associated with other forms of typical cirrus at the same level, often changing into other forms of cirrus in a short time.

Cirrostratus clouds are thin, whitish veils, sometimes covering the entire sky. Halos around the sun or moon, caused by their ice-crystal composition, frequently identify this cloud type.



Cirrus clouds are thin, white, feathery clouds in patches or narrow bands. They are composed of ice crystals of varying size. Larger crystals often trail down vertically and have given rise to the name “mares’ tails.”



Cirrocumulus clouds contain small, white individual puffs. They may contain some supercooled water droplets mixed in with the ice crystals. Cirrocumulus is rare and is sometimes called "mackerel sky."

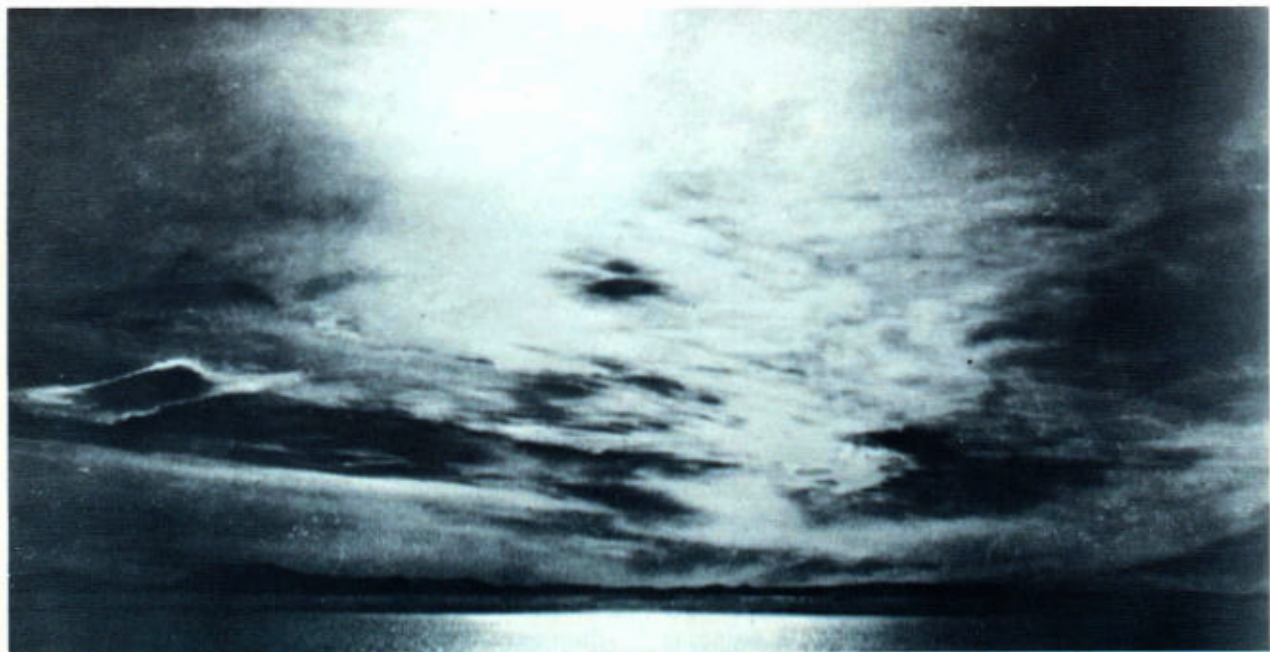

Cirrostratus is a thin, whitish, transparent cloud layer appearing as a sheet or veil. It generally produces a halo around the sun or moon.

Cirrus-type clouds may be produced in several ways. Often they are the forerunner of warm-front activity and give advance warning. Sometimes they are associated with the jet stream and usually are found on the south side of the jet. They may also be produced from the anvil tops of thunderstorms. The value of cirrus clouds in fire weather is their advance warning of warm-front activity and their use in indicating high-altitude moisture and wind direction and speed.

Middle Clouds

Middle clouds have bases ranging from 6,500 feet up to 20,000 feet. Altocumulus and altostratus clouds fall into this group. Middle clouds are most generally formed by either frontal or orographic lifting, but may be formed

in other ways. Often they are associated with lifting by convergence in upper-air troughs and sometimes develop with thunderstorms.

Altocumulus are white or gray patches, with each individual component having a rounded appearance. Altocumulus may appear as irregular cloudlets or in definite patterns such as bands or rows parallel or at right angles to the wind. Usually, the stronger the wind, the more distinct the pattern. Altocumulus are usually composed of water droplets and often are supercooled.

Altostratus appears as a gray or bluish layer or veil with a sort of fibrous texture. It may be made up of supercooled water droplets or a mixture of water droplets and ice crystals. It tends to cover the entire sky, and the sun will shine through dimly as through a frosted glass.



Altocumulus are white or gray patches or rolls of solid cloud. They are distinguished from cirrocumulus by the larger size of the cloud elements. Altocumulus clouds are usually composed of water droplets, often supercooled, but may contain some ice crystals at very low temperatures.

As altostratus becomes thicker and lower, the sun becomes obscured. If it becomes dense and low enough, it becomes nimbostratus and takes on a wet and rainy appearance due to widespread precipitation. If the precipitation evaporates before reaching the ground, it is called virga.

Three special types of middle clouds are of considerable importance in identifying weather conditions. The lens-shaped lenticular cloud appears over the ridge and to the lee of mountain ranges. Lenticular clouds indicate waves in the air flow caused by strong winds blowing across the range. The clouds form in the rising current on the upwind side of the wave crest and dissipate in the downward flow on the other side.

The castellanus type of cloud consists of

cumuliform masses in the form of turrets, usually arranged in lines. They indicate marked instability at high levels, and their occurrence in the forenoon is a warning of possible thunderstorm activity in the afternoon.

Clouds with rounded lower surfaces in the form of pouches or udders are called mamma. They are most common on the underside of cumulonimbus anvils. The pendulous blobs of cloud are sinking into the clear air immediately below because they contain droplets and ice crystals. As the droplets and crystals evaporate, they chill the air in the pendants. By this chilling, they keep the air denser than the surrounding clear air. The process ends when all



Altostratus appears as a gray or bluish layer having a fibrous appearance, often associated with altocumulus. Frequently, it is composed of a mixture of supercooled water droplets and ice crystals. Light rain or snow often falls from it.



Nimbostratus is a gray or dark massive cloud layer diffused by more-or-less continuous rain or snow which usually reaches the ground. It is thick enough to blot out the sun. Lower ragged clouds often appear beneath the nimbostratus layer.

cloud particles have evaporated. Pilots have reported that the downdrafts within mamma are quite weak. However, any adjacent thunderstorms will have zones of marked turbulence.

Low Clouds

The bases of low clouds range from the surface to 6,500 feet. Low clouds include stratus, stratocumulus, and nimbostratus.

Nimbostratus clouds form a gray, often dark, layer usually accompanied by continuously falling rain or snow. The precipitation usually reaches the ground, but occasionally only virga appears. Nimbostratus usually develops from thickening and lowering alto-stratus. Stratus fractus or scud clouds often appear beneath the nimbostratus layer.

Stratus and stratocumulus are very common and widespread. They usually occur beneath an inversion and are fairly thin, ranging from a few hundred to a few thousand feet thick. Stratus forms a low, uniform sheet, dull gray in appearance. It is composed of water droplets and does not produce rain, although it may produce drizzle. Fog is simply a stratus cloud lying on the surface. When a fog layer lifts, as it frequently does during the forenoon, it becomes a stratus layer. In some localities, particularly the west coast, stratus is referred to as high fog.

Fog is important in fire weather because of its effect on the moisture content of forest fuels. While fog is forming or persisting, conditions are favorable for fuels to absorb moisture. Fog occurs during calm or light-wind



Stratus is a low, gray cloud layer with a fairly uniform base and top. Usually it does not produce precipitation, although it may cause some drizzle or snow grains. Stratus often forms by the lifting of a layer of fog.



Stratocumulus clouds consist of gray or bluish patches or layers with individual rolls or rounded masses. They are generally composed of small water droplets and may produce light drizzle,

conditions in a stable atmosphere and is formed in several ways. Radiation fog is formed when moist air cools to its dew point at night over a strongly radiating surface. Some vertical mixing is necessary to produce a layer of fog of significant thickness. Advection fog forms when warm, moist air passes over a cool surface and its temperature is reduced to the dew point. Many fogs are a combination of these two types. Upslope fog forms when moist, stable air is forced to rise along a sloping land surface. This type occurs especially along the western edge of the Great Plains when mT air moves northwestward from the Gulf of Mexico. Fog may also occur in connection with fronts, particularly in advance of warm fronts where evaporating rain falling through a layer of cold air near the surface saturates the cold air.

The distinction between stratus and stratocumulus is not particularly important. Stratocumulus shows individual rolls or rounded masses, usually soft and gray. It forms when the air is somewhat unstable, whereas stratus forms in stable air. Like stratus, it is composed of small water droplets and may produce light drizzle.

Clouds with vertical development include cumulus and cumulonimbus. These are irregularly shaped masses with domes or turrets and have a cauliflower appearance. They usually appear in groups, and individual cloud bases are at about the same altitude. The height of the bases, which is the condensation level described in chapter 4, depends upon the air temperature and the amount of moisture in the atmosphere. Cumulus clouds are formed near the top of rising convection columns, and their bases may



Cumulus clouds are detached clouds in the form of rising mounds or domes. They are dense, have sharp outlines, and the upper portion often resembles a cauliflower. They are composed of a great density of small water droplets; ice crystals may appear in the tops of larger cumulus.

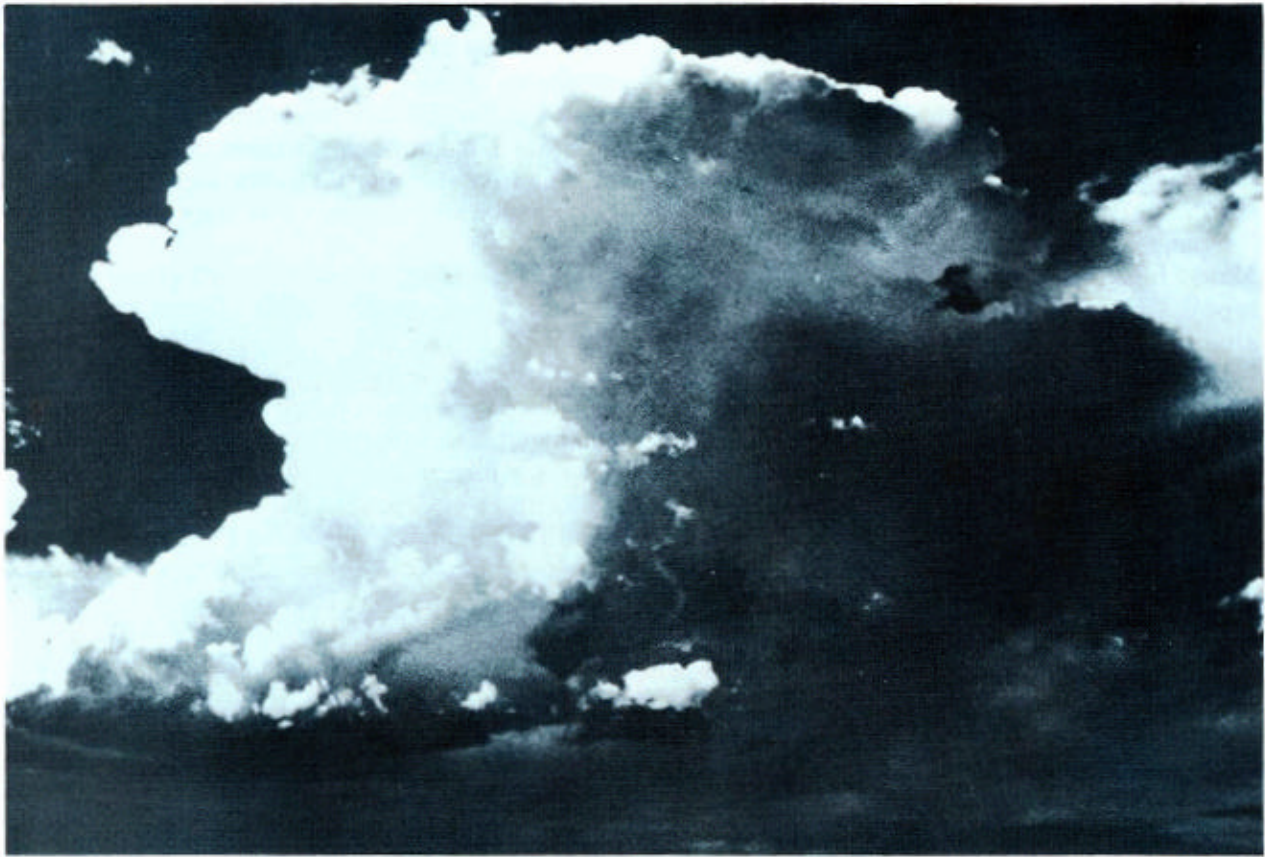

Cumulonimbus clouds are heavy and dense with considerable vertical development sometimes reaching the tropopause. The top often takes on the shape of an anvil. Cumulonimbus, often abbreviated to "cb," is frequently accompanied by lightning and thunder, rain, sometimes hail, and on occasion a tornado or waterspout.

range in height from a few thousand feet to 15,000 feet or more. Their presence is of special interest in fire weather as an alert to possible convection in the surface layer. They are a common type during the fire season, particularly in mountainous regions.

The most common type of cumulus is a small, puffy type occurring during fair weather, called cumulus humili or fair weather cumulus. They appear after local surface heating becomes sufficiently intense to support convection, and dissipate in the late afternoon as surface heating decreases and convection ceases. These clouds have relatively flat bases, rounded or cone-shaped tops, and are usually isolated or in small groups. Their vertical growth is usually restricted by a temperature inversion which makes the tops fairly uniform. Occasionally a single cloud element will develop vertically to some height. True fair-

weather cumulus clouds, however, remain flat, but their presence indicates local updrafts that may influence fire behavior.

The danger from cumulus clouds is more acute, however, if the air is sufficiently moist and unstable to support their growth into towering cumulus. Virga or rain sometimes falls from the base of large cumulus.

The final stage of cumulus development is the cumulonimbus or thunderhead, which is characterized by a flat anvil-like formation at the top. The stretched-out shape of the anvil indicates the direction of air motion at that level. The anvil top is composed of sheets or veils of ice crystals of fibrous appearance which are sometimes blown off to form cirrus-type clouds. Dissipating anvils give the appearance of dense cirrus and are sometimes referred to as false cirrus.

The greater the vertical development of cumulonimbus, the more severe the thunderstorm. Tops of cumulonimbus may extend to altitudes of 60,000 feet or higher and often reach the tropopause. Rain or snow showers usually accompany cumulonimbus clouds, and thunder, lightning, and hail are common.

Cumulus and cumulonimbus clouds not associated with frontal or orographic lifting indicate strong surface heating and atmospheric instability from the surface up through the level of the cloud tops. Surface winds are likely to be gusty and increase in speed as the cumulus forms. Other convection phenomena

such as dust devils, whirlwinds, and considerable turbulence may be present. In addition to lightning, strong cold downdrafts present a threat from well developed thunderheads. Because of the importance of thunderstorms in fire weather, we will discuss them in detail in the following chapter.

Cumulus cloud caps often form atop the convection columns over large forest fires. Their moisture source may be almost entirely water vapor from the combustion process, or it may be water vapor entrained with air through which the column rises. Such clouds occasionally produce showers, but this is quite rare.

KINDS OF PRECIPITATION

Precipitation products can be divided into three basic classes depending on their physical characteristics when they strike the earth:

Liquid, freezing, and frozen.

Rain and drizzle are the two kinds of liquid precipitation. The difference is mainly one of size and quantity of droplets. Drizzle droplets range in size from about 1/500 to 1/50 inch. Drizzle is formed in, and falls from, stratus clouds, and is frequently accompanied by fog and low visibility. Raindrops range in size from about 1/100 to 1/4 inch. They are much more sparse than drizzle droplets. Rain may come from liquid droplets formed by the coalescence process in warm clouds, or from melted snowflakes originally formed in cold clouds by both the ice crystal and coalescence processes. The snowflakes melt when they reach air with above-freezing temperatures. Rainfall intensity may vary from a few drops per hour to several inches in a matter of minutes. Heavier rainfall usually consists of larger drops.

Freezing rain and freezing drizzle are formed and fall as liquid drops that freeze on striking the ground. The drops may be above-freezing, but usually they are supercooled and freeze upon striking the ground or other cold objects. This occurs usually with warm-front rain formed in the warm air above the frontal surface, and then supercooled as it falls through the cold air beneath the front. The temperature at the ground must be lower than 32°F.

Frozen precipitation consists of snow, snow pellets, sleet and hail.

Snow consists of crystals of ice formed in pure ice clouds or in mixed clouds. The larger snowflakes are built up by the coalescence process. Air beneath the cloud must be near or below freezing, or the snow will melt before reaching the ground. The heaviest snowfalls occur when the temperature of the cloud portion from which the snow is falling is not much below freezing.

Snow pellets are white opaque grains of ice, usually round. They form when ice crystals coalesce with supercooled droplets, and usually occur in showers before or with snow. They range in size from 1/16 to 1/4 inch.

Sleet consists of transparent hard pellets of ice, about the size of raindrops, that bounce on striking the ground. They are formed by freezing of raindrops or by refreezing of partly melted snowflakes falling through a below-freezing layer of air. Sleet occurs most commonly with warm fronts.

Hail consists of balls of ice ranging in size from 1/5 inch to several inches in diameter. They have layerlike structures indicating that they have grown by successive steps. Hailstones apparently begin their growth when supercooled water droplets impinge on ice pellets. The liquid water freezes on the ice pellet to form a layer of ice. This process is repeated until the hailstone falls out of the cloud. The repetition

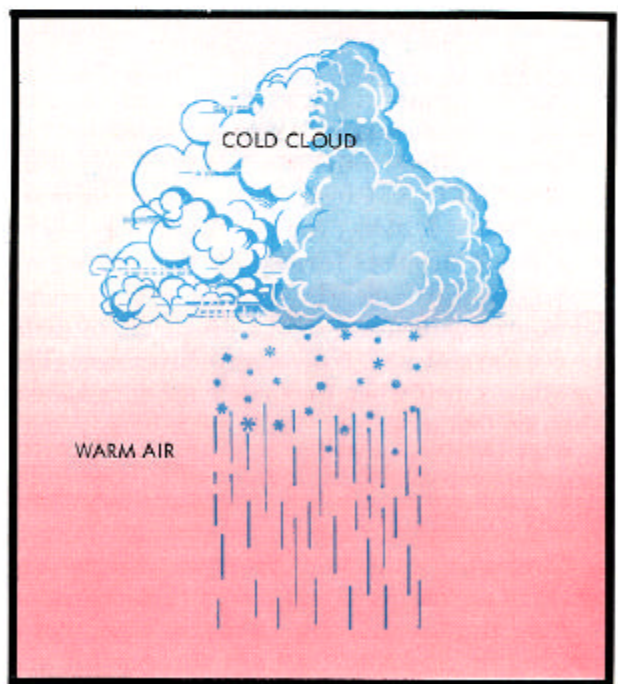
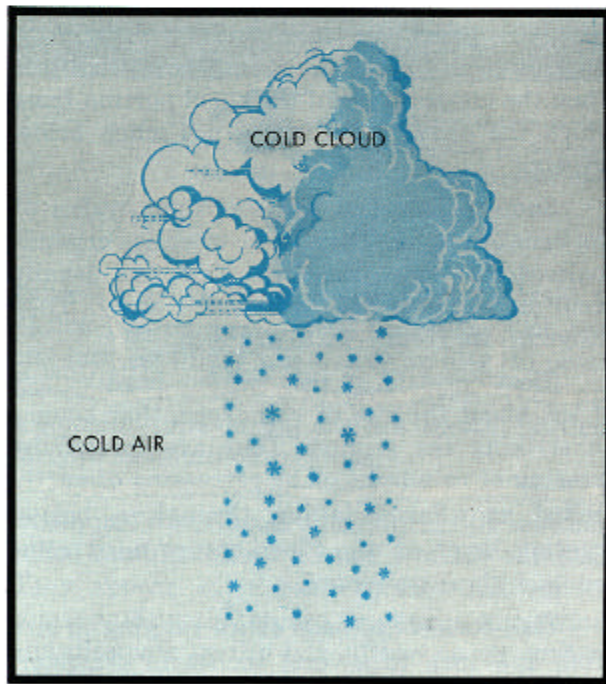
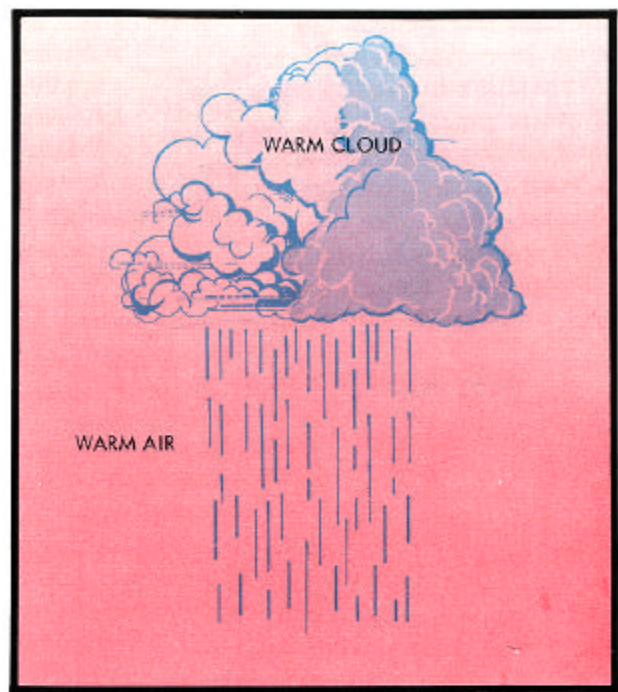
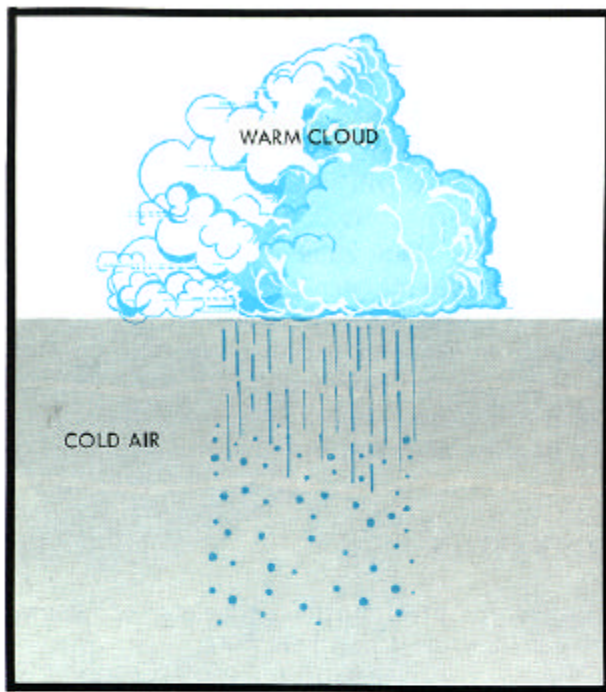

Top.— Sleet is formed by the freezing of liquid raindrops or the refreezing of partly melted snowflakes as they fall through a below-freezing layer of air.

Bottom.— Snow consists of crystals of ice formed in pure ice clouds or in mixed clouds, built up by the coalescence process and falling to the ground through cold air so that the flakes do not melt.

Top—Rain arriving at the ground may begin as liquid drops, formed by the coalescence process in warm clouds, which then fall to the ground through warm air.

Bottom.—Or rain may begin as snowflakes formed by the ice crystal and coalescence processes in cold clouds. The snowflakes subsequently melt as they fall through warm air.

may be due to the hailstone being caught in strong updrafts and carried upward into the region of supercooled droplets. It is also possible for the process to begin at very high altitudes, in which case the hailstone grows as it falls through successive concentrations of supercooled water. Hail is associated with thunderstorms and very unstable air.

There are two other forms in which moisture from the atmosphere is deposited on the ground. These are dew and frost. Dew and frost do not fall,

but instead are deposited when water vapor condenses or sublimates on the ground or on objects near the ground. Dew forms when air next to the ground or to cold objects is chilled to the dew point of the air, but remains above freezing. A common example is the deposit of water that forms on a glass of ice water. Frost forms by sublimation when the air is chilled to its dew point and the dew point is below freezing. Dew and frost forming on forest fuels at night can add considerably to the fuel moisture.

MEASUREMENT OF PRECIPITATION

Precipitation is measured on the basis of the vertical depth of the water or melted snow. Snow, sleet, hail, and other solid forms are also measured on the basis of the depth of the unmelted form. Our common unit of measurement is the inch.

The standard rain gage is an 8-inch cylindrical container with an 8-inch funnel at the top and a measuring tube inside. The cross-sectional area of the measuring tube is exactly one-tenth that of the funnel top. Thus, if 0.01 of an inch of precipitation falls, it is 0.1 inch deep in the measuring tube. The stick used to measure the precipitation is graduated in inches, tenths, and hundredths, so that 0.01 inch of rain is indicated for each 0.1 inch of stick length. When snow is measured, the funnel and measuring tube are removed, and only the outside cylindrical container is used. Snow caught in the gage is melted and measured in the measuring tube to

obtain the liquid equivalent of the snow.

Several types of recording gages that make continuous records of the precipitation are also in use. The tipping bucket gage can be used only for rain. For each 0.01 inch of rain, an electrical impulse is recorded. Another type is the weighing-type gage which can be used for either snow or rain. This device simply weighs the snow or rain that is collected. The weight is recorded continuously in inches of water on a chart attached to a revolving drum.

The rain gage should be exposed in the open away from large buildings or trees. Low bushes, fences, and walls are not objectionable, provided that the gage is placed at a distance of at least twice the height of the object. The top of the gage should be level.

SUMMARY

In this chapter we have learned that air becomes saturated either by the addition of moisture, or, more commonly, by cooling to the dew point. In saturated air, clouds form by the condensation of water vapor, which takes place on fine particles called condensation or sublimation nuclei.

Cloud droplets grow to sizes large enough to precipitate by the ice-crystal process, in which water vapor is transferred from evaporating, supercooled liquid droplets to ice crystals where sublimation takes place, or by coalescence of droplets or ice crystals into rain-

drops or clumps of snowflakes. Precipitation falls in the form of liquid rain or drizzle, freezing rain or drizzle, or frozen snow, sleet, or hail.

Clouds are classified according to their structure as stratus or cumulus, and according to their altitude as high, middle, low clouds, and those with large vertical development. In the last group are cumulonimbus or thunderstorm clouds. The weather associated with the thunderstorm has such serious effects on fire weather that the entire next chapter will be devoted to it.

Chapter 10

THUNDERSTORMS

Two characteristics of thunderstorms make them an important element in fire weather. The first is the fire-starting potential caused by lightning strikes from cloud-to-ground. The second is the thunderstorm downdraft which spreads out upon nearing the ground, producing strong, shifting, and gusty winds for a short time.

Wildland fires may be started by lightning most anywhere on the North American Continent where thunderstorms occur. But the problem is most serious where thunderstorms produce little or no precipitation that reaches the ground. These so-called “dry” thunderstorms occur mainly in the mountainous West. Several hundred wildfires can be started by lightning during one day on a single forest or district, overwhelming all possible fire control efforts. In dry periods, such fires have burned hundreds of thousands of acres in the Western United States and Canada during a few days.

On the beneficial side, heavy precipitation from “wet” thunderstorms moistens fuels, decreases the activity of going fires, and lessens the risk that lightning strikes will start fires. But let us not become overconfident! The few fires that do start may be hard to find and may “sleep” until the woods dry out, and then suddenly become major conflagrations.

THUNDERSTORMS

A thunderstorm is a violent local storm produced by a cumulonimbus cloud and accompanied by thunder and lightning. It represents extreme convective activity in the atmosphere, with both updrafts and downdrafts reaching high speeds. The thunderstorm depends upon the release of latent heat, by the condensation of water vapor, for most of its energy. We learned in chapter 1 that for each pound of liquid water condensed from vapor, more than 1,000 B.t.u.'s of heat energy is released.

Tremendous amounts of this energy are released in a single well-developed thunderstorm. The amount may well exceed 10 times the energy released in a World War II atomic bomb. And it is estimated that there are 45,000 thunderstorms occurring daily over the earth. Part of the heat energy is converted to kinetic energy of motion to cause the violent winds which usually accompany thunderstorms.

A thunderstorm, as we experience it, is composed of one or more individual convective cells or units. A cell may range from a few miles to 10 miles in diameter. A cluster of cells, each in a different stage of development, with interconnecting cloud masses may extend for 50 miles. Each convective cell has its individual identity and life cycle, even though cumulus cloud bases may join to form a solid overcast which obscures the multicellular structure.

Because thunderstorms seriously affect the inception and behavior of wildfire, we will consider them in some detail. We will first discuss the environmental conditions necessary for, and the process of, thunderstorm development. Then, we will look into the life cycle of an individual cell, the phenomenon of lightning, the type of thunderstorms, and finally consider briefly the most violent of all storms, the tornado, which on occasion occurs with thunderstorms.

CONDITIONS NECESSARY FOR THUNDERSTORM DEVELOPMENT

Thunderstorms have their origins in cumulus clouds. But only a few cumulus clouds develop into thunderstorms. Certain atmospheric conditions are necessary for this development to take place. These are: (1) Conditionally unstable air, (2) some triggering mechanism to release the instability, and (3) sufficient moisture in the air.

These factors may be present in varying degrees so that in one situation on a sultry afternoon only fair-weather cumulus will form, while in another situation numerous thunderstorms will develop. In the first situation, the instability in the lower atmosphere may be offset by stability aloft, which prevents strong convective activity essential to the development of cumulonimbus clouds.

For thunderstorm formation, the air must be conditionally unstable through a deep layer. Convection must develop well beyond the freez-

ing level for an electrical potential to be produced which will cause a lightning discharge. The conditional instability is released when the air is lifted to the level of free convection. Beyond this level, the lifted air is buoyant and rises freely and moist-adiabatically until it has cooled to the temperature of the surrounding air. (We will consider this process more thoroughly in the next section.)

The triggering mechanism necessary to release the instability is usually some form of lifting. This lifting may be orographic or frontal, or may be produced by low-level converging flow or by heating from below. Any of these processes may bring warm air from near the surface up to the level of free convection, above which it will rise freely. We have discussed these lifting actions in chapters 4 and 9 and need not dwell on them here.

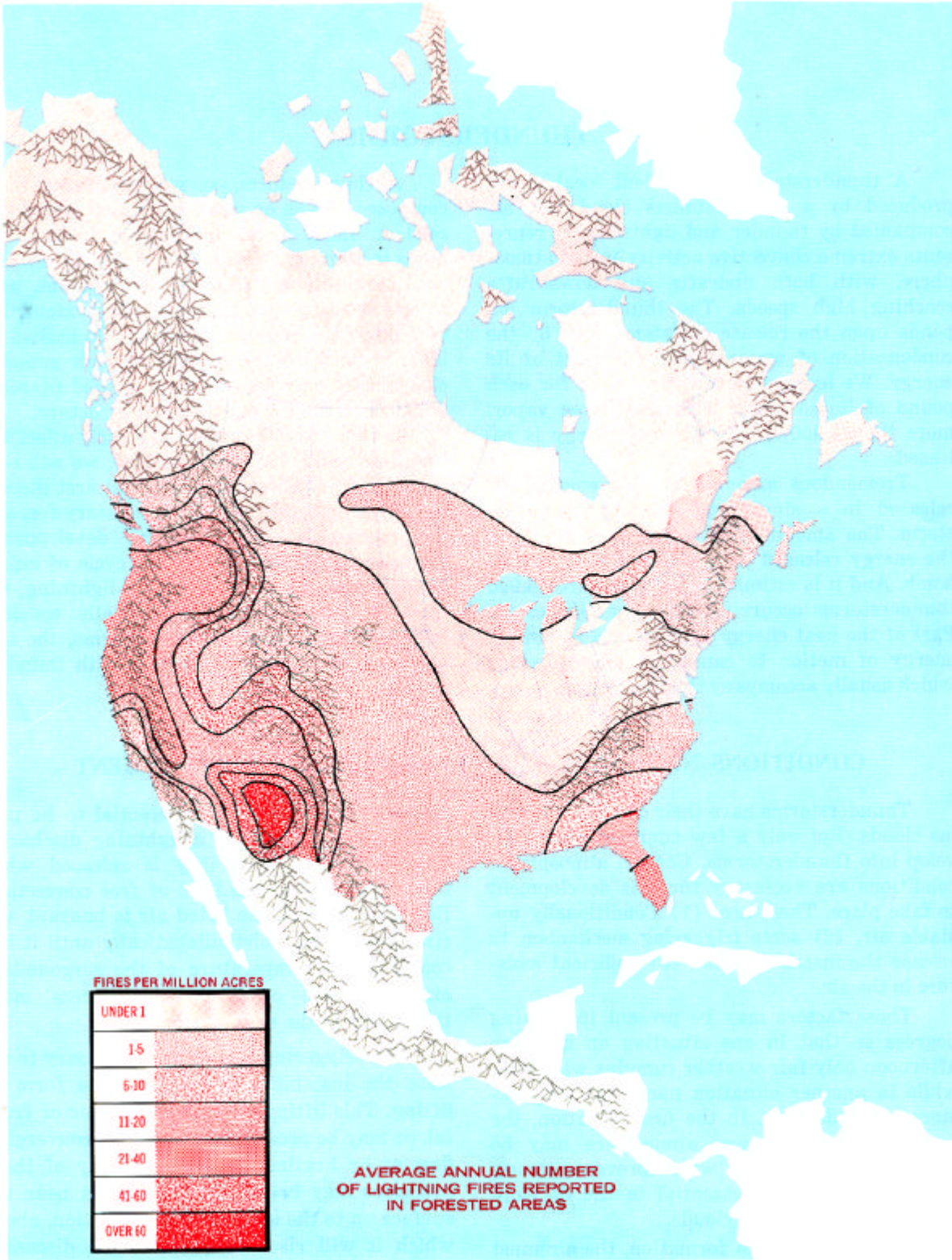

Most lightning fires occur in the mountainous West and the Southwest. More thunderstorms occur in the Southeast but start fewer fires because of the accompanying rain.

Another triggering mechanism is the further steepening of the temperature lapse rate through advection of cold or warm air. Cold air moving in at high levels will steepen the lapse rate and make the atmosphere more unstable. Warm air moving in at low levels will have the same steepening effect.

Clouds will not form in air containing little moisture even though other factors present may be favorable for thunderstorm development. For cumulus clouds to develop, air must be lifted to the condensation level, and for significant cloud growth it must be further lifted to the level of free convection. The greater the air moisture, the lower the condensation

level and the easier it is for the level of free convection to be reached. Above the condensation level, the heat released in the condensation process tends to make the rising air more buoyant. For this reason, the air need be only conditionally unstable rather than absolutely unstable for thunderstorms to develop when other factors are favorable.

The building upward of cumulus clouds into cumulonimbus may be prevented by layers of air at intermediate levels which are initially very stable or dry. Thunderstorms are unlikely to develop under these conditions even though all other factors favor development.

THERMODYNAMICS OF THUNDERSTORM DEVELOPMENT

The development of a thunderstorm in a moist, conditionally unstable atmosphere can best be illustrated on an adiabatic chart. On the accompanying graph the line ABCDE represents the early morning temperature structure of the lower atmosphere. The stable layer AB is the nighttime surface inversion. From B to D, the atmosphere is conditionally unstable since its lapse rate lies between the moist-adiabatic and dry-adiabatic lapse rates. An analysis of the graph will show that convection from the surface cannot take place unless energy is provided either in the form of heating or lifting.

If a parcel at A were lifted, its temperature would decrease at the dry-adiabatic rate of 5.5°F. per thousand feet until saturation is reached, and above that level it would decrease at the lesser moist-adiabatic rate. If the moisture content of the parcel were such that condensation would be reached at level F, the temperature of the parcel would follow the dry adiabat from A to F, then the moist adiabat from F to G and up to E. During this lifting from A to F to G, the parcel would be colder than the surrounding air whose temperature is represented by ABG, and would have negative buoyancy. Without energy being supplied to the parcel to lift it, the parcel would tend to return to the surface. Above the level G, the parcel, with its temperature following the moist adiabat to E, would be warmer than the surrounding air, would have positive buoyancy, and would rise freely.

The area on the graph enclosed by AFGB is

approximately proportional to the energy which must be supplied before free convection can take place. It is usually referred to as a negative area. The area enclosed by GCDE is a measure of the energy available to accelerate the parcel upward after it reaches level G. It is referred to as a positive area. In forecasting, thunderstorms are considered to be more likely if the positive area is large and the negative area is small. It must be remembered, however, that whatever the size of the negative area, it represents negative buoyancy that must be overcome before the conditional instability is released.

A common method by which the negative area is reduced is through daytime heating. Suppose that by afternoon on the day under consideration, the surface temperature has increased to A' and mixing and heating have produced a dry-adiabatic layer from the surface to level G'. The negative area would be completely eliminated, and convection of air from the surface to level G' would be possible. Let us suppose also that the moisture content of this layer is such that condensation would take place in rising air upon reaching level G'. Above level G', which in this case would be both the convective condensation level and the level of free convection, the temperature of rising air would follow the moist-adiabatic line G'E'. The air would rise freely, because it would be increasingly warmer than the surrounding air

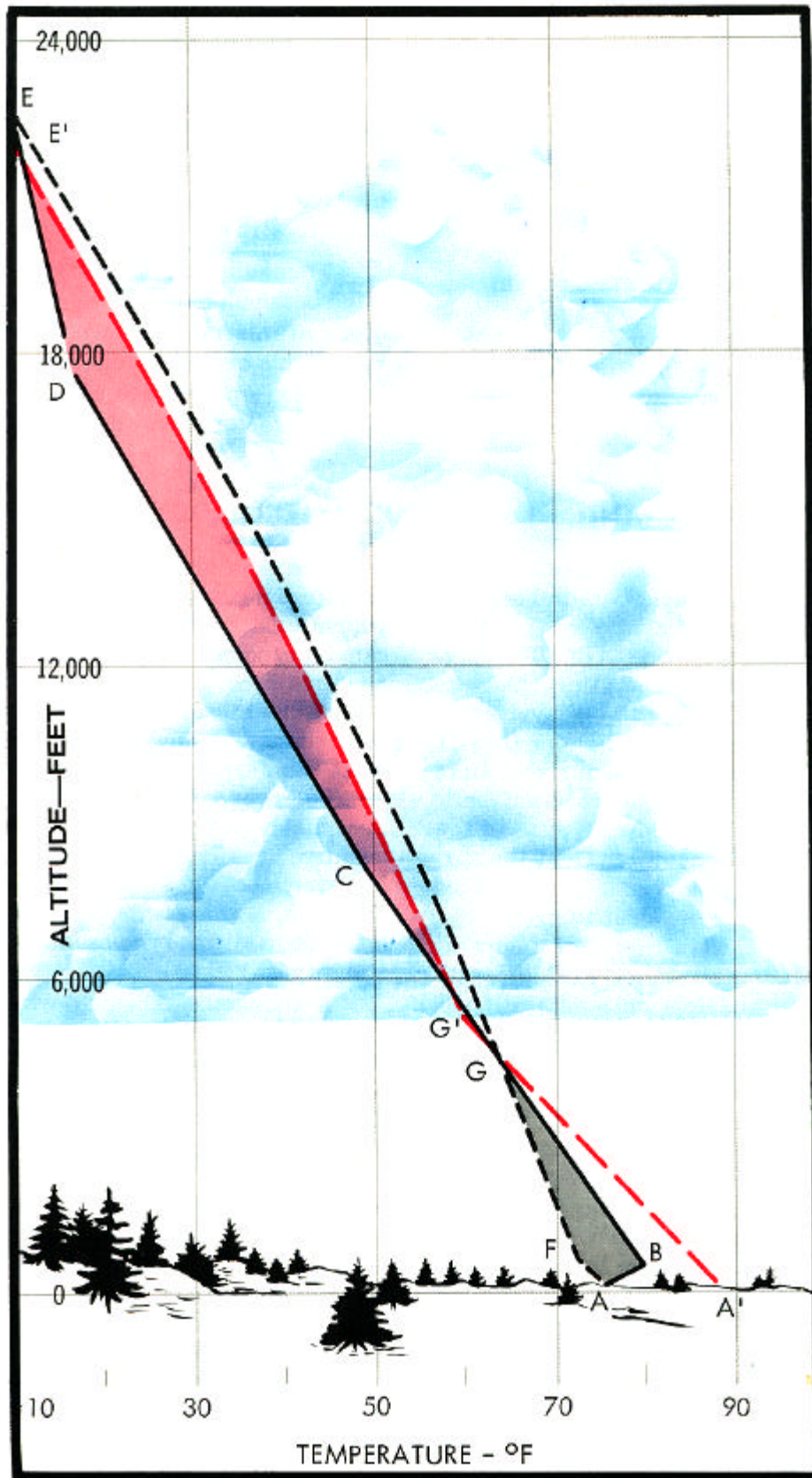

Thunderstorms can be triggered in a conditionally unstable atmosphere by surface heating. Line *ABCDE* represents an early morning lapse rate, and *A'G'CDE* a corresponding afternoon lapse rate.

up to level D and would remain warmer until level E' is reached. It is in the region from G' to E' that energy is made available. Here, the upward motion is accelerated and highly turbulent.

If more moisture is present in the surface air layers, the rising air parcels reach saturation at a lower level. This has the effect of decreasing the negative area and increasing the positive area. As the atmosphere becomes more unstable, either through heating near the surface or cooling at upper levels, the lapse rate steepens and the line ABCDE tilts more to the left. Again the negative area decreases and the positive area increases. In either case—more low-level moisture or greater instability—thunderstorms become more likely.

The convection column that creates a thunderstorm does not exist as a completely isolated chimney. Friction at the outer surface of the column, between the rising air and the nonrising environment, causes small eddies. Air from outside the column which is slightly cooler, tends to mix somewhat with the rising air, and also to be carried upward. This is called entrainment. Entrainment of cooler air tends to weaken the updraft; nevertheless, the type of analysis given in our example is a good guide to thunderstorm probability.

The moisture content of the air surrounding the updraft also influences thunderstorm development. The entrainment of very dry air may cause the updraft to cease. Cumulus clouds sometimes build upward into a thick layer of very dry air aloft. The cloud particles evaporate, and the cloud disappears because of entrainment. Conversely, if the air aloft is moist,

entrainment will help to maintain a supply of water vapor for condensation. Thus, moisture content of the air aloft is an important factor in thunderstorm probability.

Our discussion of the thermodynamics of thunderstorm development has been concerned with air-mass thunderstorms caused by heating. For this type of thunderstorm the parcel method of analysis of temperature soundings is very useful. But thunderstorms may also be produced by frontal or orographic lifting, in which deep layers of air instead of parcels are lifted. Temperature soundings can also be analyzed for thunderstorm probability which may result from the lifting of layers, but these procedures are much more complex, and we will consider them only briefly.

We should recall from chapter 4 that a layer with a lapse rate less than dry-adiabatic stretches and becomes more unstable as it is lifted, even if no condensation takes place. For thunderstorm development, condensation is required and the distribution of moisture through the layer must be considered. If moisture in a lifted layer is adequate and decreases sufficiently from the bottom to the top, the bottom of the layer will become saturated before the top of the layer. The temperature of the bottom of the layer will cool at the lesser moist-adiabatic rate, and the temperature of the top at the greater dry-adiabatic rate until the top of the layer also reaches saturation. This process rapidly produces instability and may result in thunderstorms if the layer is relatively deep. Orographic and frontal lifting of layers often produce thunderstorms protruding from the top of broad, solid cloud masses.

LIFE CYCLE OF A THUNDERSTORM CELL AND ASSOCIATED WEATHER

As mentioned above, the thunderstorms that we see are composed of one or more individual convection cells. A storm composed of a cluster of cells will contain cells in various stages of development and decay. Each cell goes through a definite life cycle which may last from 20 minutes to 1½ hours, although a cluster of cells, with new cells forming and old ones dissipating, may last for 6 hours or more.

Individual thunderstorm cells have many variations in growth and behavior, but typically go through three stages of development and

decay. These are the cumulus, mature, and dissipating stages.

Cumulus Stage

The cumulus stage starts with a rising column of moist air to and above the condensation level. The lifting process is most commonly that of cellular convection characterized by strong updraft. This may originate near the surface or at some higher level. The growing cumulus cloud is visible evidence of this convective activity, which is continuous from well

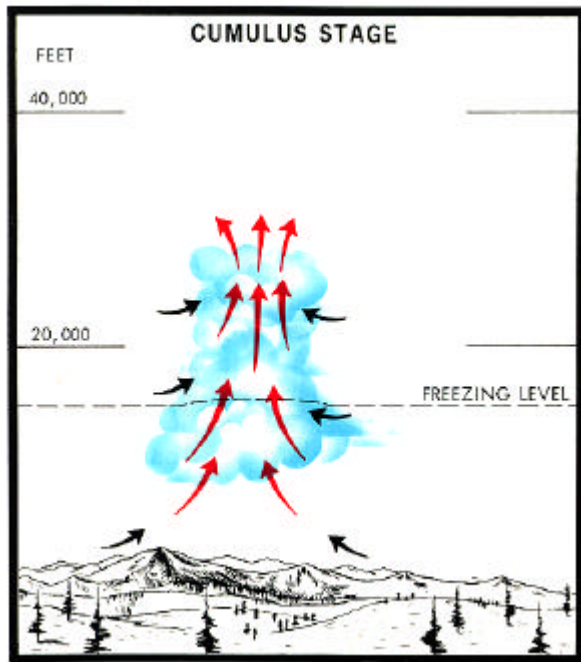

The cumulus stage of a thunderstorm cell is characterized by a strong updraft, which is fed by converging air at all levels up to the updraft maximum. Rain does not occur in this stage.

below the cloud base up to the visible cloud top. The primary energy responsible for initiating the convective circulation is derived from converging air below. As the updraft pushes skyward, some of the cooler and generally drier surrounding air is entrained into it. Often one of the visible features of this entrainment is the evaporation and disappearance of external cloud features.

The updraft speed varies in strength from point-to-point and minute-to-minute. It increases from the edges to the center of the cell, and increases also with altitude and with time through this stage. The updraft is strongest near the top of the cell, increasing in strength toward the end of the cumulus stage. Cellular convection implies downward motion as well as updraft. In the cumulus stage this takes the form of slow settling of the surrounding air over a much larger area than that occupied by the stronger updraft. During this stage the cumulus cloud grows into a cumulonimbus.

Cloud droplets are at first very small, but they grow to raindrop size during the cumulus stage. They are carried upward by the updraft beyond the freezing level where they remain liquid at

subfreezing temperatures. At higher levels, liquid drops are mixed with ice crystals, and at the highest levels only ice crystals or ice particles are found. During this stage, the raindrops and ice crystals do not fall, but instead are suspended or carried upward by the updraft. Air temperature within the rapidly growing cell in this stage is higher than the temperature of the air surrounding the cell.

Surface weather during the cumulus stage is affected very little. Surface pressure falls slightly. Shade provided by the cloud during the daytime allows the ground to cool, and fuel temperatures approach that of the surface air. Except for cells that develop above a frontal surface, the surface wind field shows a gentle

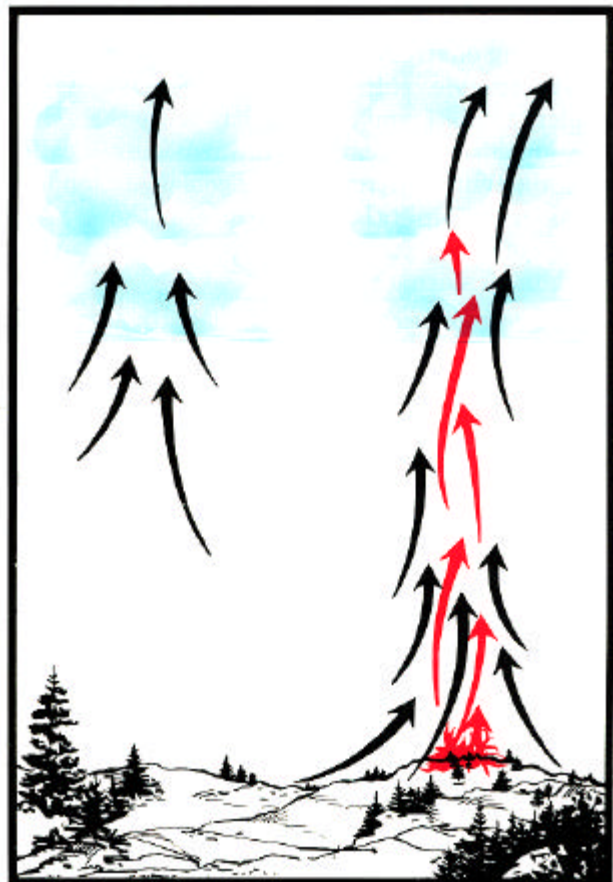

In the cumulus stage, the principal effect of a thunderstorm on a going fire is produced by the updraft. As a cumulus cloud drifts over a fire, the updraft into the cloud and the convection column over the fire reinforce each other. The updraft is strengthened, and spotting potential is increased.

inturning of winds forming the area of convergence under the updraft. The updraft at the center feeds into the growing cloud above. If such a cloud with its updraft passes over a going fire, the convection from the fire may join with the updraft and they may reinforce each other. This joining may strengthen the inflow at the surface and cause the fire to become active.

Mature Stage

The start of rain from the base of the cloud marks the beginning of the mature stage. Except under arid conditions or with high-level thunderstorms, this rain reaches the ground. Raindrops and ice particles have grown to such an extent that they can no longer be supported by the updraft. This occurs roughly 10 to 15 minutes after the cell has built upward beyond the freezing level. The convection cell reaches its maximum height in the mature stage, usually rising to 25,000 or 35,000 feet and occasionally breaking through the

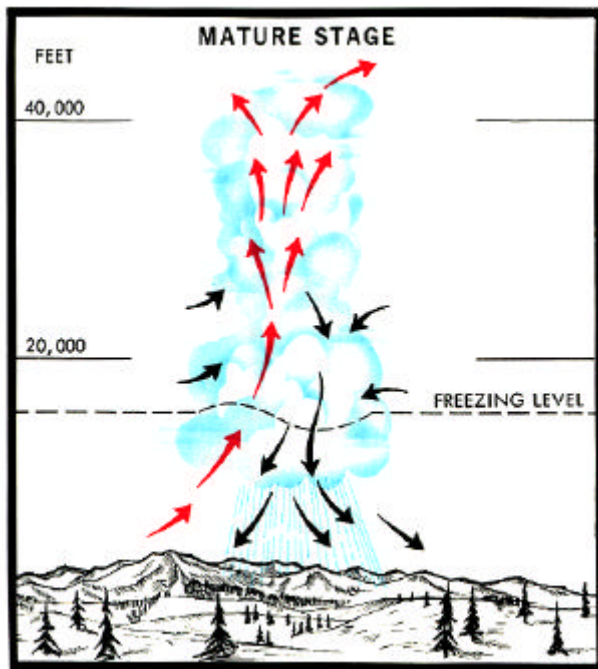

The mature stage, the most active portion of the thunderstorm cycle, begins when rain starts falling out of the base of the cloud. The frictional drag exerted by the rain or other precipitation initiates a downdraft. There is a downdraft in part of the cell and an updraft in the remainder. The updraft is warmer, and the downdraft is colder, than the air surrounding the cell.

tropopause and reaching to 50,000 or 60,000 feet or higher. The visible cloud top flattens and spreads laterally into the familiar "anvil" top. A marked change in the circulation within the cell takes place.

As raindrops and ice particles fall, they drag air with them and begin changing part of the circulation from updraft to downdraft. The mature stage is characterized by a downdraft developing in part of the cell while the updraft continues in the remainder. The air being dragged downward by the falling rain becomes cooler and heavier than the surrounding air, thus accelerating its downward fall. Melting of ice and evaporation of raindrops cool the descending air. The change from updraft to downdraft is progressive. The downdraft appears to start first near the freezing level and spreads both horizontally and vertically. The updraft continues in its decreasing portion of the cloud and often reaches its greatest strength early in the mature stage. The speed of the downdraft within the cell varies, but may reach 30 m.p.h. Usually it is not so strong as the updraft, which may exceed 50 m.p.h. The downdraft becomes most pronounced near the bottom of the cell cloud where the cold air appears to cascade downward.

Below the cloud, in the lower 5,000 feet or so above the ground, the downward rush of cool air decreases somewhat. The effect of a fiat ground surface is to force the downdraft to pile up and spread out horizontally as a small, but intense, cold front. This horizontal outflow of air produces a strong and highly turbulent surge, frequently referred to as the "first gust." As this initial surge strikes an area it causes a sharp change in wind direction and an increase in speed. This wind discontinuity is most pronounced on the forward side of the thunderstorm. Here, the storm's movement is added to the speed of the outflow. To the rear, the storm's movement opposes the outflow and makes it much less pronounced.

Because the outflowing air is cold and heavy, the first gust is accompanied by a sudden temperature drop, sometimes as much as 25°F., and a sharp rise in surface pressure. The pressure remains high as long as the dome of cold air is over an area.

The mature stage is the most intense period of the thunderstorm. There is extreme turbulence in and below the cloud, with intense gusts superimposed on the updraft and downdraft. Lightning frequency is at its maximum. Heavy rain and strong gusty winds at ground level are typical of most thunderstorms, though precipitation at the ground may be absent in high-level thunderstorms, which we will discuss later. The heaviest rain usually occurs under the center of the cell, shortly after rain first hits the ground, and gradually decreases with time.

Dissipating Stage

As the downdrafts continue to develop and spread vertically and horizontally, the updrafts continue to weaken. Finally, the entire thunderstorm cell becomes an area of downdrafts, and the cell enters the dissipating stage. As the updrafts end, the source of moisture and energy for

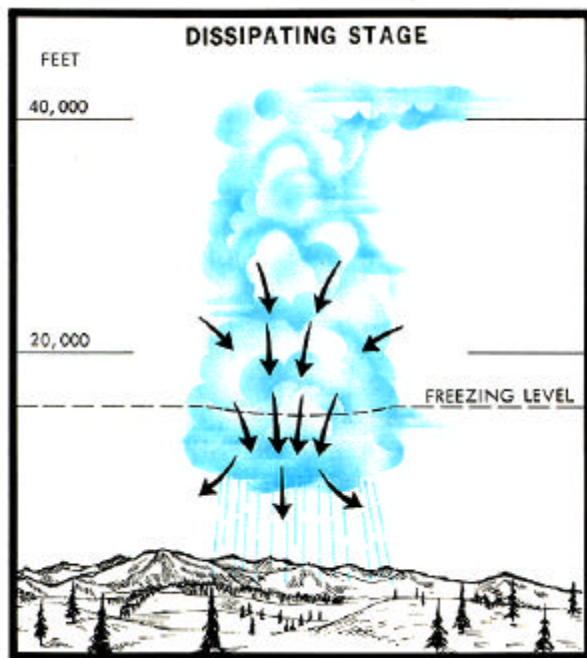

The downdraft spreads over the entire cell, and the updraft disappears in the dissipating stage. Light rain falls from the cloud. Gradually the downdraft weakens, rain ends, and the cloud begins to evaporate.

continued cell growth and activity is cutoff. The amount of falling liquid water and ice particles available to accelerate the descending air is diminished. The downdraft then weakens, and rainfall becomes lighter and eventually ceases. As long as downdrafts and rain continue, temperatures within the cell are lower than in the surrounding air. As the downdrafts cease, air in the cell is gradually mixed with, and becomes indistinguishable from, the surrounding air. Then, either complete dissipation occurs or only stratiform clouds at lower levels and the separated anvil top remain.

As the thunderstorm cell dissipates, the surface signs also disappear unless new cells develop. Wind, temperature, and pressure gradually return to the conditions outside the thunderstorm area.

New Cell Development

Although each thunderstorm cell goes through a life cycle, different cells within a cluster at any time may be in various stages of development. As old cells die out, new ones are formed. The downdraft and outflowing cold air appear to be an important factor in the development of new cells. The preferred place for new cell development is the area between two cells where their outflowing cold air collides and causes upward motion in the overlying warm air. The forward edge of the cold dome may also act as a small cold front and cause lifting of warm air and the development of new cells. Local topographic features may also influence the initiation of new cells. A cell may form over a mountain peak and drift off downwind as another cell develops over the peak.

The interaction of cells in a cluster can cause false impressions of the behavior of thunderstorms. Thunderstorm cells usually move in the direction of the airflow in the layer in which they develop but at a speed somewhat less than this airflow. Cell growth, decay and replacement of old cells, and the extension of the storm area by new cell formations may make the storm system appear to split, back into the wind, turn at right angles to the wind, or move faster than the general wind itself. The true movement is difficult to discern from the ground, particularly in mountain topography.

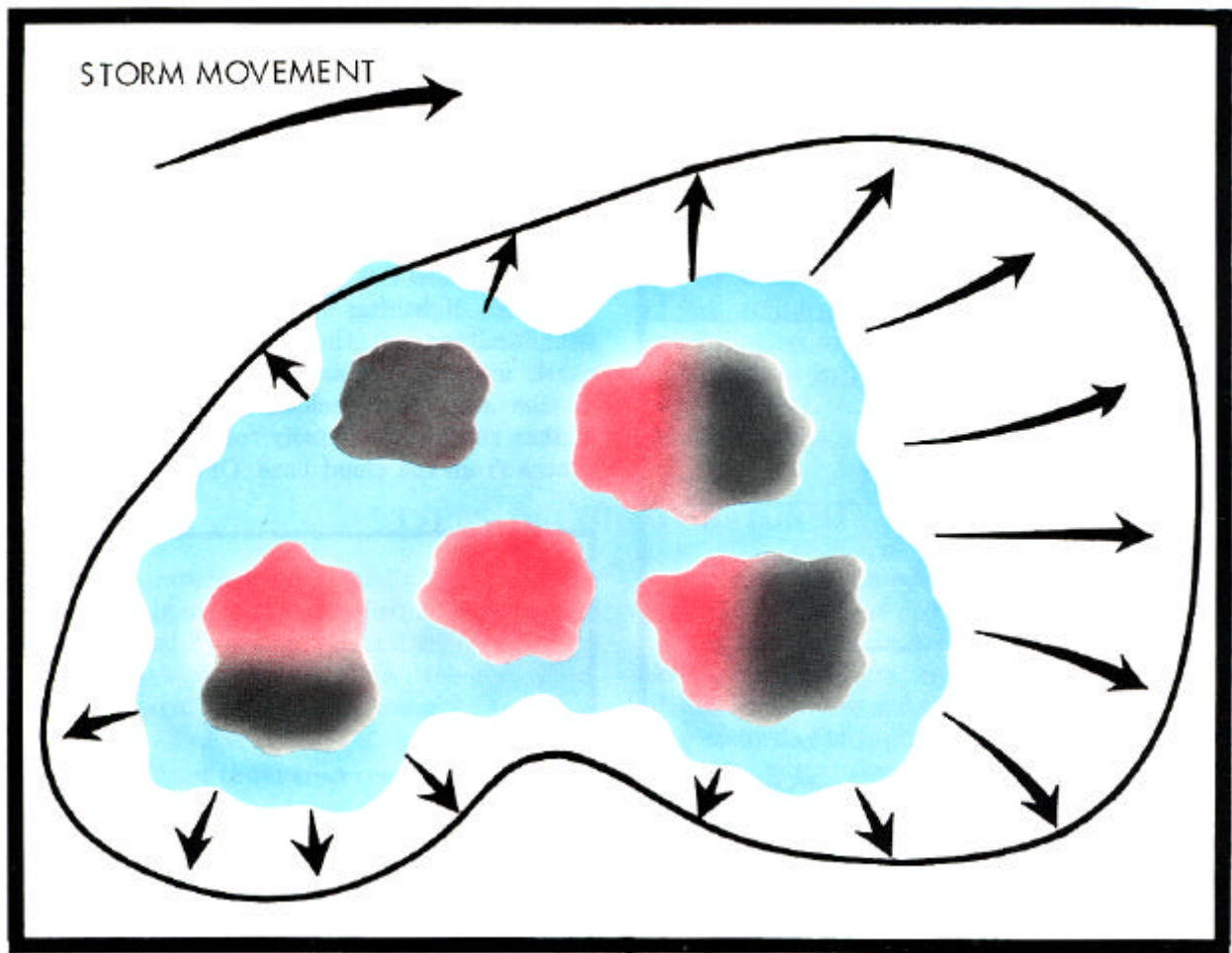

Thunderstorms are often made up of clusters of convective cells, in various stages of development. embedded in a cloud mass. Developing cells have only an updraft (red), mature cells have both an updraft and a downdraft (gray), and dissipating cells have only a downdraft. The downdrafts from different cells often merge into an outflow from the thunderstorm mass.

LIGHTNING

Lightning occurs in a thunderstorm when an electrical potential builds up that is strong enough to exceed the resistance of the atmosphere to a flow of electrons between the centers of opposite charge. Most cloud-to-ground discharges originate in the cloud and progress to the ground. They take place in two stages. First, a leader stroke works its way downward to the ground in a series of probing steps. Then a number of return strokes flash upward to the cloud so rapidly that they appear as a flickering discharge. The average number of return strokes in a lightning flash is four. Lightning discharges taking place within a cloud usually do not show return strokes.

The processes that generate the electrical

potential are not fully understood, and a number of theories have been advanced. Regardless of the method or methods by which electrical potentials are generated, measurements with specialized electronic equipment have established where, in the thunderstorm, opposite charges tend to accumulate and how charges vary during storm development.

In fair weather, the atmosphere has a positive electrical charge with respect to the earth. This fair weather potential gradient has an average value of about 30 volts per foot. When a cumulus cloud grows into a cumulonimbus, the electric fields in and near the cloud are altered

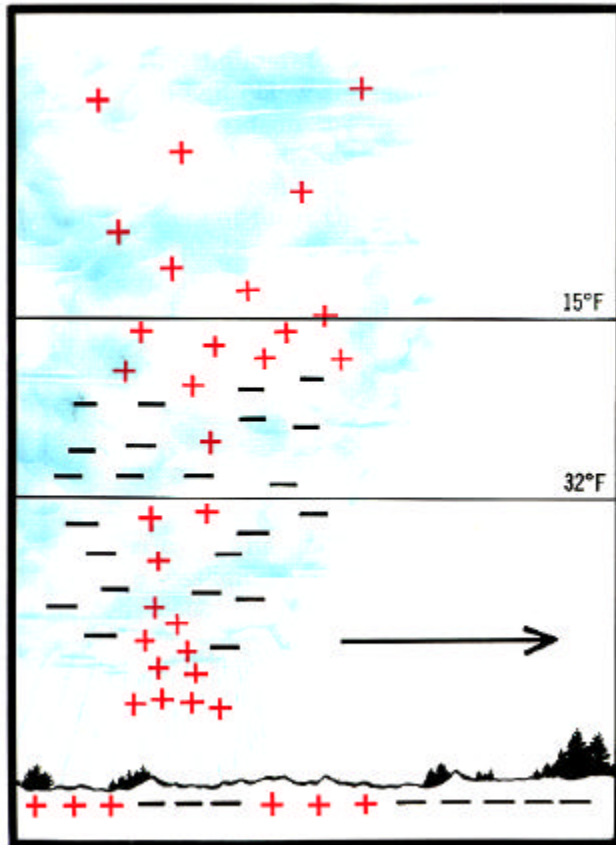

As a thunderstorm cloud becomes electrified, positive charges tend to accumulate in the top of the cloud and negative charges in the lower portion. Smaller positive and negative charge areas also develop. Rapidly falling rain carries positive charges downward and creates a positive charge center in the precipitation core.

and intensified. The upper portion of the cloud becomes positively charged and the lower portion negatively charged, although other smaller positive and negative charges develop. The negative charge near the cloud base induces a positive charge on the ground—a reversal of the fair-weather pattern.

Cloud-to-ground lightning is usually a discharge between the negative lower portion of the cloud and the induced positive charge on the ground and accounts for about one-third of all discharges. Most lightning discharges, however, are within a cloud or cloud-to-cloud. Many of the within-cloud discharges take place between the negative charge in the lower portion of the cloud and a positive charge center carried downward from the upper portion of the cloud by the falling rain in the precipitation core. This positive charge center disappears when the heavy rain stops.

Lightning sometimes occurs in the cumulus stage, but reaches its greatest frequency at the time

the cell reaches maturity and its greatest height. The start of rain beneath the cloud base at the beginning of the mature stage marks the onset of the greatest lightning danger. The most extensive horizontal flashes occur at altitudes extending from the freezing level upward to where the temperature is about 15°F. Although lightning may occur throughout a thunderstorm cell, the strongest flashes to the earth usually originate in the lower portion of the cell. Many cloud-to-ground lightning strikes reach out laterally for considerable distances from the cloud base. Once lightning has

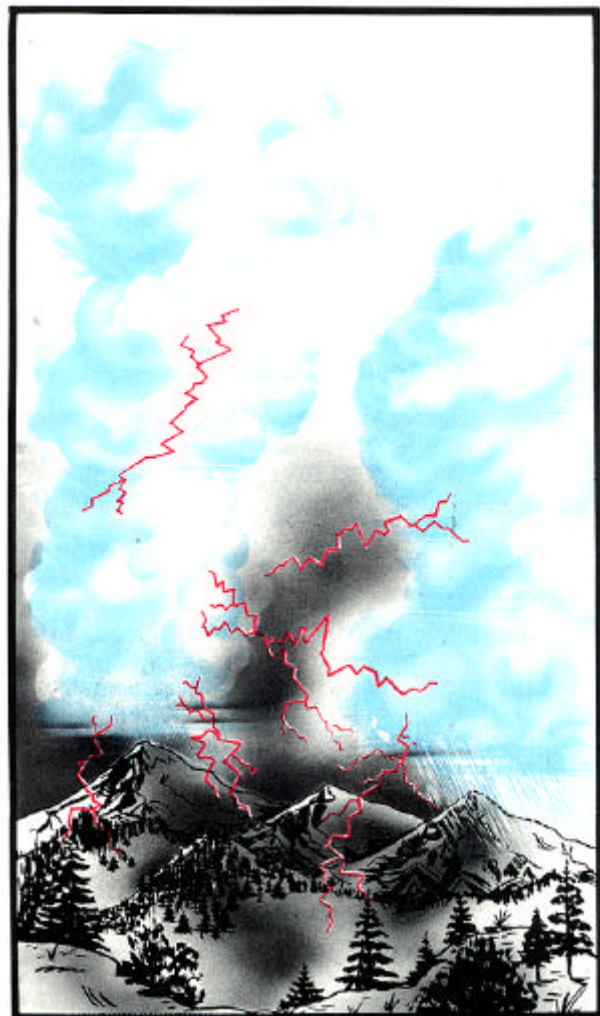

Lightning discharges take place within a cloud, from cloud-to-cloud, or from cloud-to-ground. Most discharges are within a cloud or from cloud-to-cloud, but the cloud-to-ground discharges are stronger. Lightning frequency is at a maximum in the mature stage.

started, it may continue well into the dissipating stage of the cell. Apparently, less cloud height is needed to maintain continuing discharges than to initiate the first. But as the height of the cell decreases after reaching maturity, the frequency of lightning flashes decreases. However, individual flashes may remain strong.

The noise of thunder is due to compression waves resulting from the sudden heating and expansion of the air along the path of the lightning discharge. These compression waves are reflected from inversion layers, mountainsides, and the ground surface so that a rumbling sound is heard, instead of a sharp ex-

plosive clap, except when the discharge is very near. Since light travels so very much faster than sound, it is possible to estimate the distance of a lightning flash using the elapsed time between seeing the flash and hearing the thunder. The distance to a flash is about 1 mile for each 5 seconds of elapsed time.

Weather radar, in which portions of transmitted radio signals are reflected back from precipitation areas in clouds and displayed as radar echoes on an indicator, is helpful in locating, tracking, and revealing the intensity of thunderstorms and their associated lightning.

TYPES OF THUNDERSTORMS

Thunderstorms are usually classified as frontal or air-mass thunderstorms. The frontal type is caused by warm, moist air being forced over a wedge of cold air. This lifting may occur with warm fronts, cold fronts, or occluded fronts.

Warm-front thunderstorms are usually embedded in large stratiform cloud masses. They are likely to be the least severe of frontal thunderstorms because of the shallow slope of the warm-front surface. Surface wind conditions, in the cold air wedge beneath the warm front, may be unaffected by the thunderstorms above.

Cold-front thunderstorms are generally more severe and occur in a more-or-less continuous line. Their bases are normally lower than those of other frontal thunderstorms.

Thunderstorms occurring along a squall line are similar to those along a cold front, but may be even more severe. Heavy hail, destructive winds, and tornadoes are usually associated with **squall-line thunderstorms**.

Thunderstorms are often associated with a warm-front type occlusion. In this case, they occur along the upper cold front and are set off by the lifting of the warm, moist air. They are usually more severe than warm-front thunderstorms and less severe than the cold-front type.

Air-mass thunderstorms are unaffected by frontal activity. They are usually scattered or isolated. Air-mass thunderstorms may be further classified as **convective** or **orographic**, although these lifting processes often act together.

Convective thunderstorms formed by convergence may occur day or night, but they tend to be most active in the afternoon. Those produced by instability resulting from advection of low-level warm air or high-level cold air may also occur day or night. The nocturnal, or nighttime, thunderstorm, which is common in the Midwest during spring and summer, is usually due to low-level warm-air advection and convergence. These storms are among the most severe found anywhere.

Orographic thunderstorms develop when moist, unstable air is forced up mountain slopes. They tend to be more frequent during the afternoon and early evening because heating from below aids in the lifting process. Storm activity is usually scattered along the individual peaks of mountain ranges, but occasionally there will be a long unbroken line of thunderstorms.

One type of air-mass thunderstorm, the **high-level** or **dry thunderstorm**, deserves special consideration because of its importance in starting wildfires. The lifting process may be orographic, convergence, cold-air advection aloft, or a combination of these, often aided by surface heating over mountain ranges. High-level thunderstorms occur most frequently in the mountainous West during the summer months.

Their distinctive feature is that their cloud bases are so high, often above 15,000 feet, that precipitation is totally or mostly evaporated before it reaches the ground. As a result, lightning strikes reaching the ground frequently start fires in the dry fuels. The downdraft and

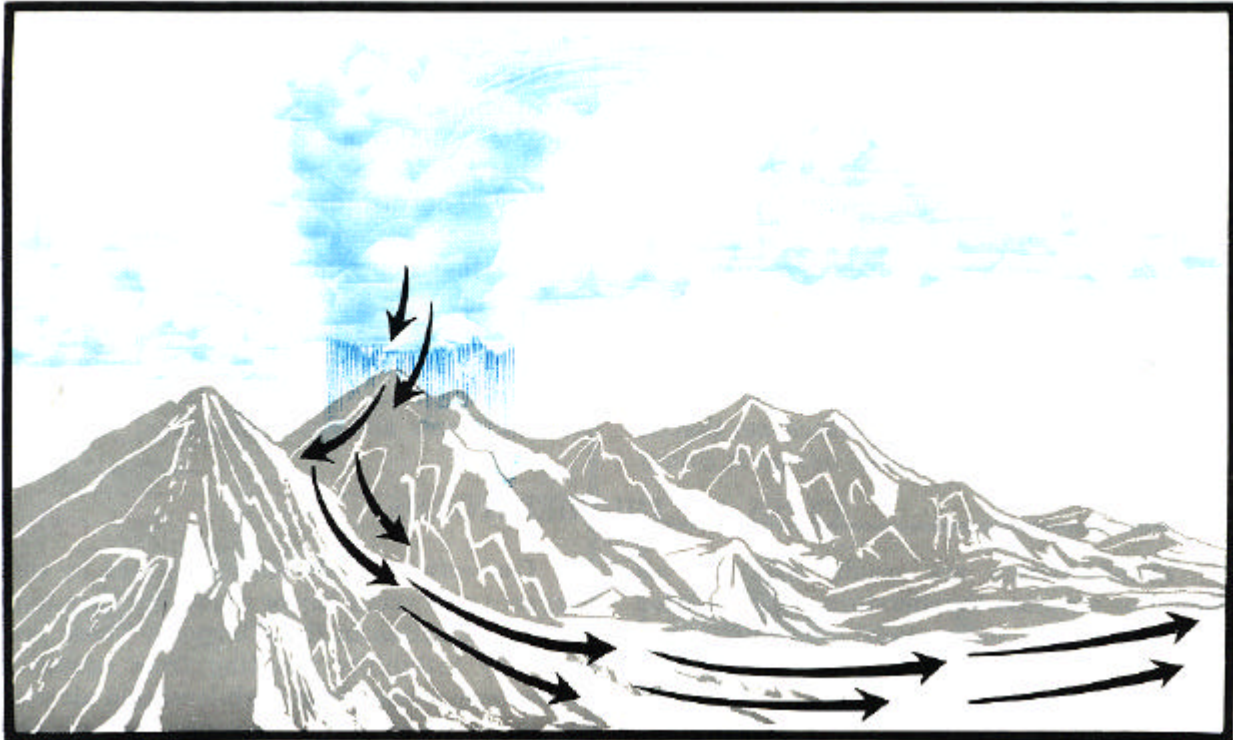

The downdraft and outflow from a high-level thunderstorm is likely to reach the ground even though the precipitation evaporates before reaching the ground. The cold, heavy air is usually guided by the topography into downslope and downcanyon flow, although flow in any direction is possible.

outflow usually reach the ground even though the precipitation does not. The cold, heavy air is generally guided by the topography into downslope and downcanyon patterns, but cross-slope flow may also occur.

There are two principal weather patterns which produce high-level storms. One is the in-flow of moist air, usually from over the Gulf of Mexico but occasionally from over the eastern subtropical Pacific, at levels of 10,000 to 18,000 feet. Thunderstorms are set off by lifting over mountains, and by heating and upslope thermal winds at higher levels in the mountains, as the moist air spreads northward from New Mexico, Arizona, and southern California. These storms usually develop in the afternoon and may extend into the evening hours.

The second important weather pattern in high-level storms is the cold Low aloft. With this pattern a closed low-pressure system aloft becomes cut off from the main belt of westerlies. The cold air within this closed Low produces instability and causes convective currents to develop. If sufficient moisture is present, thunderstorms will form. They can develop at any time of the day or night, but are most active in the afternoon when they are assisted by daytime heating. The movement of a closed upper Low is erratic and very difficult to predict. The Low may move in virtually any direction, may deepen or fill, or may be picked up by a trough moving eastward at a higher latitude.

The Far West is a favorite place for closed Lows to develop. They may meander around for several days or a week before finally dissipating or moving on.

TORNADOES

Tornadoes are violent whirling storms which may occur with severe thunderstorms. They take the form of a funnel or tube building downward

from a cumulonimbus cloud. These violently rotating columns of air range in size from a hundred feet to a half mile in



A tornado is a violently whirling vortex which occurs with a severe thunderstorm. The rotating tube builds downward from the cumulonimbus cloud. Destruction results from extremely strong wind and low pressure.

diameter. Technically, they are not tornadoes unless they touch the ground, but are referred to as “funnel clouds.” When they do reach the ground, they are the **most destructive of all atmospheric phenomena on the local scale**. They travel with a speed of 25 to 50 m.p.h., usually from southwest to northeast, and often skip along. The length of the path of a single

tornado is usually just a few miles, but some tornadoes have remained active for more than a hundred miles—striking the ground for a few miles, skipping an area, then striking the ground again, and so on.

The great destructiveness of tornadoes is caused by the very strong wind and **extremely low pressure**. Winds in the rapidly spinning vortex have never been measured, but from the destruction it is estimated that winds may exceed 500 m.p.h. The low pressure causes houses and structures to virtually explode when a tornado passes over them. There is a sudden decrease in pressure around the house, while on the inside the pressure changes little. The resulting difference in pressure between the outside and the inside is sufficient to blow the house apart.

Tornadoes have been reported in all of the 48 contiguous States and Southern Canada, but **they are rare west of the Rocky Mountains**. Maximum occurrence is in the central Midwest, and there is a secondary maximum in the Southeast. In Southern United States tornadoes may occur in any month of the year, but farther north the maximum occurrence is in late spring and early summer. They generally occur with prefrontal squall lines, but they may develop with other violent thunderstorms, including those in hurricanes. Tornadoes usually occur in the late afternoon or evening. Their main effect on the wildland fire problem is the resulting blowdown timber in forested areas that often creates high fire hazard.

SUMMARY

Thunderstorms are important in fire control because they start fires by lightning, blow them out of control with the downdraft and outflow, or put them out with rain. In this chapter, to increase our understanding of these severe storms, we have discussed various aspects of thunderstorm development. We have seen that a conditionally unstable atmosphere,

sufficient moisture, and some lifting or triggering mechanism are necessary for their development. Once initiated, thunderstorm cells go through a life cycle consisting of cumulus, mature, and dissipating stages. The most active stage is the mature stage when lightning discharges, the thunderstorm downdraft, and precipitation are all at their maximum.

Chapter 11

WEATHER AND FUEL MOISTURE

The moisture content of live and dead vegetation is not in itself a weather element. It is a product, however, of the cumulative effects of past and present weather events and must be considered in evaluating the effects of current or future weather on fire potential. Fuel moisture content limits fire propagation. When moisture content is high, fires are difficult to ignite, and burn poorly if at all. With little moisture in the fuel, fires start easily, and wind and other driving forces may cause rapid and intense fire spread. Successful fire-control operations depend upon accurate information on current fuel moisture and reliable prediction of its changes.

The determination of exact fuel-moisture values at any time is complicated by both the nature of the fuels and their responses to the environment. Fuel moisture changes as weather conditions change, both seasonally and during shorter time periods. This fact, coupled with known attributes of different fuels, provides a useful basis for estimating fire potential in any forest or range area. This chapter describes some of the more important relationships involved.

WEATHER AND FUEL MOISTURE

In fire-control language, fuel is any organic material—living or dead, in the ground, on the ground, or in the air—that will ignite and burn. Fuels are found in almost infinite combinations of kind, amount, size, shape, position, and arrangement. The fuel on a given acre may vary from a few hundred pounds of sparse grass to 100 or more tons of large and small logging slash. It may consist of dense conifer crowns over heavy and deep litter and duff, or may be primarily underground peat. There is even the “urba-forest,” an intimate association of wild-land fuels and human dwellings. Any one composite fuel system is referred to as a **fuel complex**.

Every fuel complex has an inherent built-in flammability potential. The extent to which this potential may be realized is limited largely by the amount of water in the fuel, but fuel

moisture is a continuous variable controlled by seasonal, daily, and immediate weather changes.

For convenience, the amount of water in fuel is expressed in percentage, computed from the weight of contained water divided by the oven-dry weight of the fuel. Fuel-moisture values in the flammability range extend from about 35 percent to well over 200 percent in living vegetation, and about 1.5 to 30 percent for dead fuels. Remember that living-fuel moisture is primarily the moisture content of living foliage, while dead-fuel moisture is the moisture in any cured or dead plant part, whether attached to a still-living plant or not. Living and dead fuels have different water-retention mechanisms and different responses to weather. Hence, we will discuss them separately before considering them together as a single fuel complex.

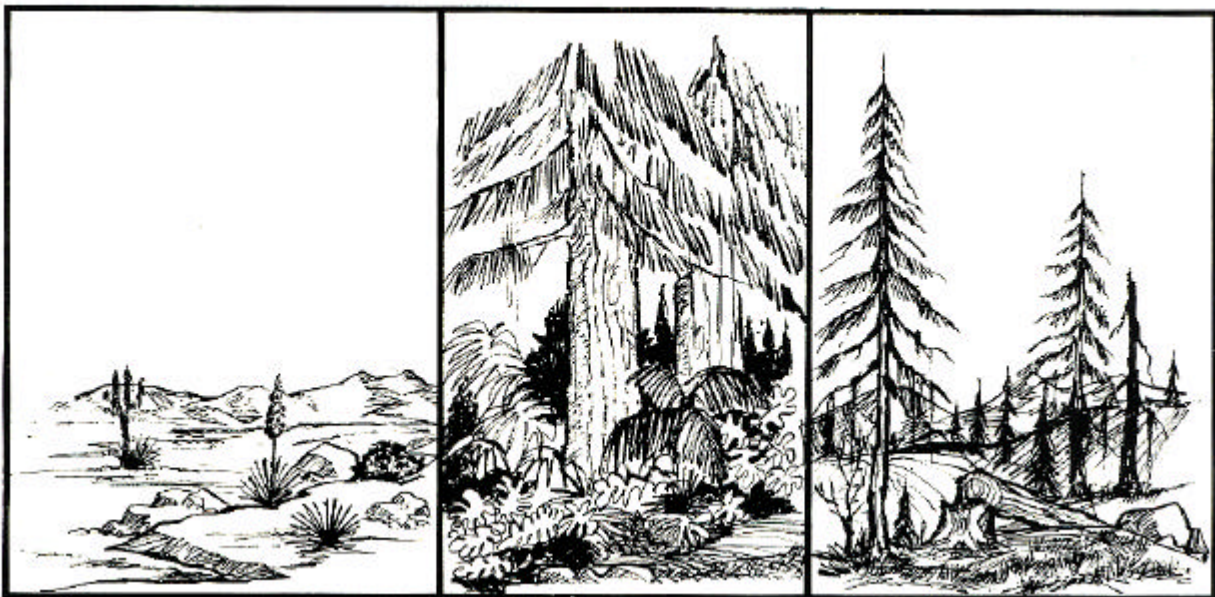

Where vegetation is plentiful, fire potential depends largely upon moisture content. The rain forest may be fire-safe virtually all the time, while the parched forest at times may be explosive.

Water in living plants plays a major role in all plant life processes. It transports soil nutrients from the roots up through conducting tissues to the leaves. In the leaves, some of the water becomes raw material from which the organic materials are manufactured for plant growth; some water transfers the manufactured products to growing tissues and storage points; and finally, some water is transpired through leaf pores to become water vapor in the atmosphere.

Seasonal Changes

The moisture content of living-plant foliage of wildland species varies markedly with seasonal changes in growth habits except in humid southern climates. These changes are usually typical for the local species and climate, but are tempered in timing by deviations from normal weather, such as amount and spacing of precipitation, date of disappearance of snow-pack, or the occurrence of unseasonably warm or cool temperatures. Thus, the beginning or ending dates of growth activity affecting plant moisture may vary 2 weeks or more, and the growth activity may vary during the season.

Growing seasons are longest in the lower latitudes and become progressively shorter toward higher latitudes. They may be as short as 60 days at the northern forest limits. Elevation and aspect affect local microclimate and produce local differences in seasonal development of many plant species. In mountain topography, for example, lower elevations and southern exposures favor the earliest start of the growing season. Moisture content of all new foliage is highest at the time of emergence. Moisture content two or three times the organic dry weight is common. The period of emergence varies according to localities, species, and local weather. The peak moisture normally declines quite rapidly during leaf growth and development, then somewhat more slowly to a terminal value leading to death or dormancy in the fall. In annual plants, the end result is the death of the plant; in deciduous shrub and tree species, the end result is the death of the foliage, while in evergreens some leaves live and others die and fall.

In organic (peat or muck) soils, the excessive

demand for moisture to support leaf emergence can result in soil desiccation and in high fire danger if soils are burnable. This problem ceases when normal evapotranspiration is established.

The decrease in plant foliage moisture is usually not smooth, but an irregular succession of ups and downs. These irregularities may result from one or more causes, including periodic changes in food-manufacturing demands, changes in weather, and variations in available soil moisture. Within the individual leaf, however, moisture is maintained within tolerable limits during the growing season through ability of the leaf to open or close the leaf pores and thus regulate the rate of transpiration to the atmosphere. Foliage moisture content may even change during the course of the day.

Effect of Type

Evergreens

Evergreens growing in climates having marked seasonal changes generally have seasonal growth cycles. Leaves that have lived through a dormant period increase in moisture content at the beginning of the new season from a minimum of perhaps 80-100 percent to a maximum of perhaps 120 percent within a few weeks. These values are typical, but do not necessarily apply to all species and regions. Moisture decreases slowly after this modest increase until the minimum is again reached at the onset of dormancy.

Within a few days of the initial increase in moisture in old leaves, twig and leaf buds open and a new crop of leaves begins to emerge. Their initial moisture may exceed 250 percent. Leaves may emerge quickly, or over an extended period, depending on species and the character of the weather-related growing season. The average moisture content of the new growth drops rapidly to perhaps 150 percent, as the new leaves grow in size until about midsummer, and then more slowly, matching the moisture content of the older foliage near the end of the growing season.

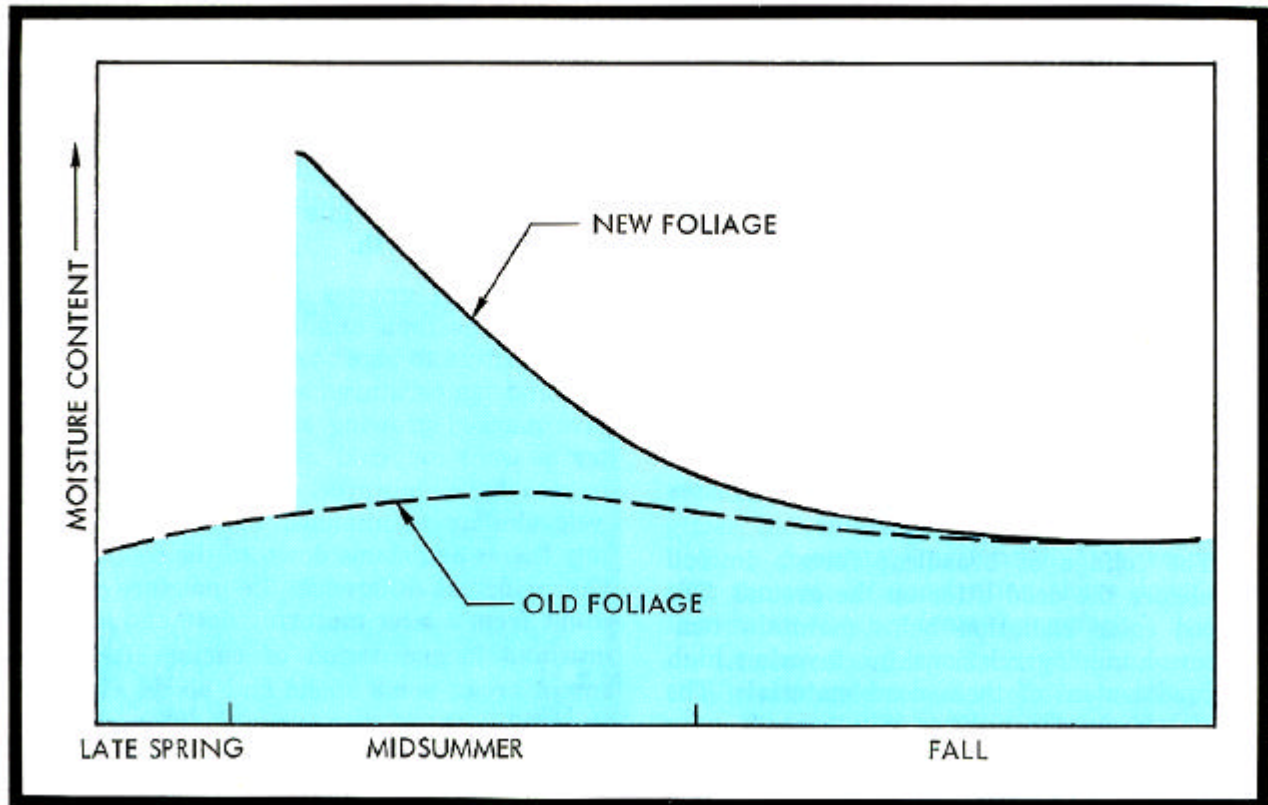

The moisture content of old foliage changes only slightly during the season, while that of new foliage is very high at emergence and then drops, first rapidly, then more slowly, matching that of the old foliage at the end of the growing season.

Different species of evergreen trees and shrubs characteristically retain a season's crop of foliage for different periods of years. This may vary among species from one season to five or more. There are also differences within species, due partly to age, health, and stand density, but mostly to the weather-dictated character of the growing season. Thus, in years of poor growth there is normally little leaf fall, and in years of lush growth the fall is heavy. As crown canopies become closed, leaf fall tends to approximate foliage production. The oldest foliage, that closest to the ground, is the first to fall, and, in time, the lower twigs and branches that supported it must also succumb and add to the dead fuel supply.

There are exceptions, of course, to the normal, seasonal growth and leaf-moisture cycle, and to the annual replenishment of foliage. Particularly striking are the variations found in the drought-resistant brush and chapparral species in the

semiarid West. It is not uncommon for midseason soil-moisture deficiency to cause cessation of growth in these species, with foliage moisture lowering to between 40 and 50 percent. Usually, these plants retain the ability to recover after the next rain. Prolonged severe drought, however, can prove fatal to major branches or even to whole shrubs. Conflagration potential is then at its peak.\

The live foliage of evergreens as a class is usually more combustible than that of deciduous species. There are several reasons, but differences in their moisture regimes are most important. All deciduous foliage is the current year's growth, and it maintains relatively high moisture content during most of the growing season. Evergreens, on the other hand, and particularly those that retain their foliage for a number of years, have much lower average foliage moisture during the growing season. Old-growth foliage with its lower moisture may constitute 80 percent or more of the total ever-

green foliage volume. Among the evergreens, too, there is greater tendency toward a mixture with dead foliage, branches, and twigs.

Deciduous Species

In contrast to the evergreens, all deciduous species contribute each year's total foliage production to the surface dead fuel accumulation. During the process of production and decline, however, there are considerable differences between groups of species in their contributions to forest flammability. Let us compare, for example, two quite different situations: first a deciduous broadleaf forest, and then grasses on the open range.

The foliage of broadleaf forests in full leaf shades the dead litter on the ground. The reduced solar radiation helps maintain temperature-humidity relationships favoring high moisture content of these dead materials. The forest canopy also reduces wind speeds near the ground—another favorable factor. The surface fuels are relatively unexposed to the elements until the forest is defoliated. Thus, ground fires in a deciduous forest in full leaf are rarely a serious threat. In addition, the live foliage of most deciduous American broadleaf forests is not very flammable, making crown fires in these types rare.

Grasses

All living wildland vegetation responds to good and poor growing seasons as determined by the weather, but annual range grasses are much more sensitive to seasonal and short-term weather variations than are most other fuels. These grasses are shallow-rooted and thus depend primarily on adequate surface soil moisture for full top development. At best, annuals have a limited growth season. They mature, produce seed, and begin to cure or dry. But deficient surface moisture at the beginning of the season, or its depletion by hot, dry weather, may shorten the growth period. Similarly, because of the weather, the curing time may vary from 3 weeks to 2 months after noticeable yellowing.

Green grass is not flammable. After its moisture content has dropped to 30 or 40 percent during the curing stage, however, grass will burn on a good burning day. At the end of the curing period, annual grasses are dead fuels, fully exposed to the high temperatures of solar radiation and to the full force of the wind. Thus, annual grasses may reach a highly flammable stage while broadleaf foliage is still in prime growth.

Perennial grasses have deeper, stronger root systems than annuals and are somewhat less sensitive to short-term surface soil moisture and temperature changes. In regions that have marked growing seasons limited by hot, dry seasons or cold winters, the perennial grasses have, however, a growth and curing cycle similar to annuals, but dieback affects only leaves and stems down to the root crowns. The principal differences in moisture content result from a later maturing date and a slower rate and longer period of curing. In warm, humid areas, some stems and blades cure and die while others may remain alive, although more or less dormant. Often, such mixtures will burn in dry weather.

Any living vegetation can be consumed by fire of sufficient intensity burning in associated dead fuels. When vegetation is subjected to heating, however, marked differences appear among species in the rates of output of combustible volatiles. The result is that the living foliage of some species absorbs nearly as much heat to vaporize its contained water as it yields when burned. Living foliage of other species, except in the period of rapid spring growth, may add significantly to the total fire heat output. Among these latter species particularly, the current foliage moisture content is important in determining total flammability.

There is no convenient or practical method for obtaining in-place measurements of live-foliage moisture. A general estimate can be made by a close eye examination of the foliage, and by touching it. Light green succulent leaves of the current year's growth mark the period of maximum moisture content. Darkening and hardening of these leaves mark the beginning of steady moisture decline until dormancy sets in. Evergreen foliage is then mostly tough and leathery.

When a plant part dies, food manufacturing and growth stop and water circulation ceases. The contained water then evaporates until the dead tissues become “air-dry.” The amount of water remaining is variable and always changing, depending on how wet or dry the environment happens to be.

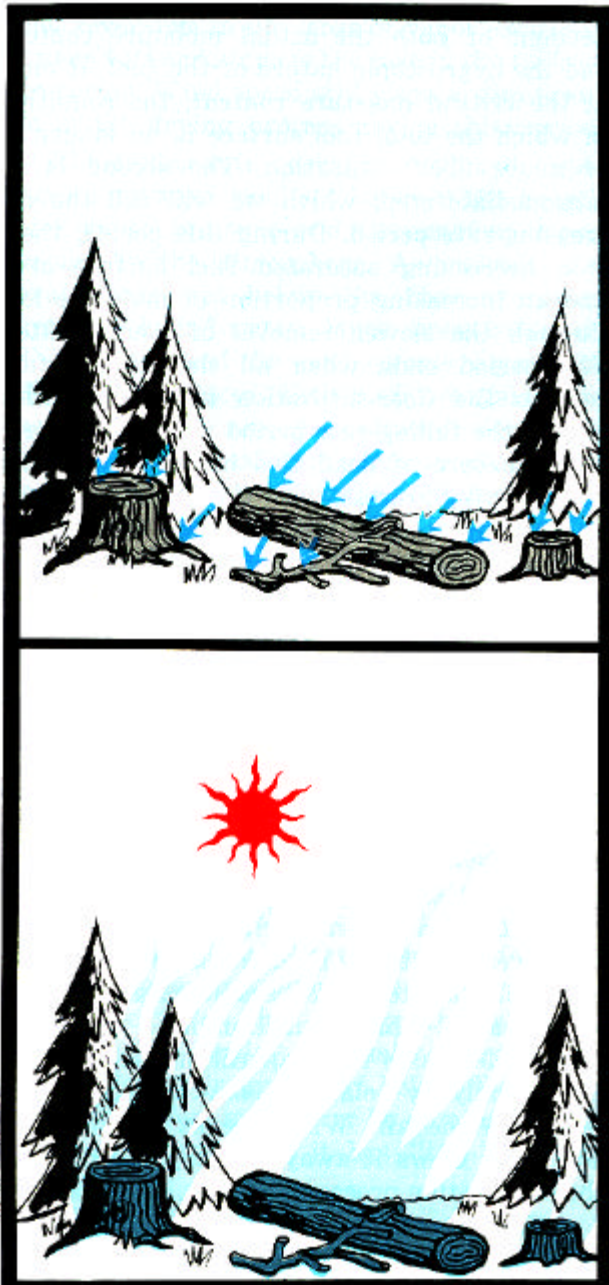

Dry, dead fuels adsorb moisture from the surrounding air when atmospheric humidity is high. When atmospheric humidity is low, moisture from moist fuels is evaporated into the surrounding air.

Fuel-Wetting Processes

Dead vegetation retains its original structure of cells, intercellular spaces, and capillaries. It can soak up liquid water like a blotter, only more slowly, until all these spaces are filled. Dead vegetation may hold two or more times its own dry weight in water. Fine materials may absorb that much in a matter of minutes, while large logs may require a season or more of heavy precipitation. In some climatic regimes, the centers of large materials may never become completely saturated. One reason is that the rate of penetration slows down with increasing distance from the surface.

A second and equally important consideration in our understanding of fuel-wetting processes is the fact that the materials making up the dead cell walls are hygroscopic. Hygroscopic materials have an affinity for moisture which makes it possible for them to adsorb water vapor from the air. This process is one of chemical bonding. We will consider it in the light of our discussions of vapor pressure, evaporation, and condensation in chapter 3 and the related growth of ice crystals at the expense of water drops in chapter 9.

Molecules of water are attracted to, penetrate, and are held to the cell, or fiber, walls by the hygroscopic character of the cell material. The water molecules that penetrate and the few molecular layers that adhere to the cell walls are called bound water. The hygroscopic bond between the cell walls and the water molecules is strong enough to effectively reduce the vapor pressure of the bound water. The layer of water molecules immediately in contact with a cell wall has the strongest hygroscopic bond and lowest vapor pressure. Successive molecular layers have progressively weaker bonds until the cell walls become saturated. At that point, the vapor pressure in the outer layer of water on the cell wall is equal to that of free water, or saturation pressure. The amount of bound water at the fiber-saturation point varies with different materials. For most plant fuels it is in the range of 30 to 35 percent of the fuel dry weight.

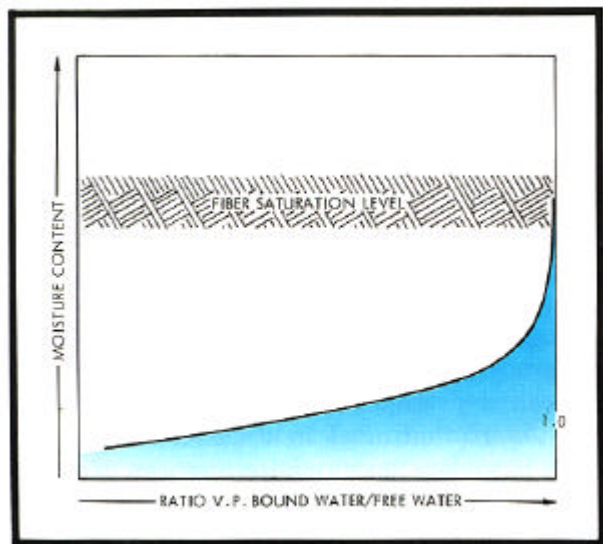

At moisture contents below the fiber-saturation level, the vapor pressure of bound water is less than that of free water. The ratio of these vapor pressures is unity at that level and decreases as moisture content decreases.

The result of the bonding phenomenon is that free water cannot persist in a cell until the cell walls become saturated. Then free water can pass through the cell walls by osmosis. Below the saturation level, moisture is evaporated from cell walls of higher moisture content and taken up by cell walls of lower moisture content until the moisture in each cell attains the same vapor pressure. In this manner, much of the moisture transfer within fuels is in the vapor phase and always in the direction of equalizing the moisture throughout a particular piece of fuel.

Dead fuels will extract water vapor from the atmosphere whenever the vapor pressure of the outer surface of the bound water is lower than the surrounding vapor pressure. In a saturated atmosphere, this may continue up to the fiber-saturation point. Full fiber saturation rarely persists long enough in the absence of liquid water to permit the necessary internal vapor transfer.

Fuel-Drying Processes

As noted above, fuel moisture can be raised to perhaps 300 percent by contact with liquid water, and to a maximum fiber saturation of around 30

percent in a saturated atmosphere through adsorption of water vapor. The reverse process of fuel drying is accomplished only by evaporation to the atmosphere.

The moisture content of dead fuels thoroughly wetted with free water within and on the surface decreases in three steps in a drying atmosphere, with different drying mechanisms dominant in each. The first step is called the constant-rate period. The rate here is independent of both the actual moisture content and the hygroscopic nature of the fuel. It ends at the critical moisture content, the condition in which the total fuel surface is no longer at or above fiber saturation. The second is an intermediate step, which we will call the decreasing-rate period. During this period, there is a decreasing saturated fuel surface area and an increasing proportion of moisture loss through the slower removal of bound water. The period ends when all the fuel surface reaches the fiber-saturation level. The third step is the falling-rate period when the hygroscopic nature of dead fuel becomes dominant in the drying process.

The process of moisture loss in the constant-rate period is somewhat simpler than those of the succeeding steps. Drying takes place by evaporation exactly as from any free-water surface. It will proceed whenever the surrounding vapor pressure is less than saturation pressure, and at a rate generally proportional to the outward vapor-pressure gradient. Wind speed during this period does not affect ultimate attainment of the critical moisture content level. But it does affect the time required to reach that point. When there is evaporation from a water surface in calm air, a thin layer next to the interface between the free water and air tends to become saturated with water vapor. This saturation near the water surface decreases the evaporation rate and dissipates only by relatively slow molecular diffusion in the air. Wind breaks up this thin layer and blows it away, thereby speeding up the evaporation process.

The intermediate decreasing-rate period may best be described as a transition step in which there is a variable change in moisture loss rate. This rate begins changing slowly within the defined limits from the linear rate of the constant-rate period to the orderly decreasing

rate characteristic of the falling-rate period. Variations in the rate of drying during the decreasing-rate period are caused by fuel and environmental factors that are difficult to evaluate and for which no general rules are available. This period is often considered as part of what we have called the falling-rate period when the error involved in calculations is considered tolerable. It is separated for our purposes because it applies only to drying and is not reversible in the sense of vapor exchange between fuel and air as is the case in the falling-rate period. Wind speed still plays a significant role in the drying process during this period.

The falling-rate period of drying depends upon an outward gradient between the bound-water vapor pressure and the ambient vapor pressure in the atmosphere. As moisture removal progresses below the fiber-saturation point, the bound-water vapor pressure gradually declines, and the vapor-pressure gradient is gradually reduced. Either of two conditions must prevail to assure continued significant drying: One is to maintain a surrounding vapor pressure appreciably below the declining bound-water vapor pressure; the other is addition of heat to the fuel at a rate that will increase its temperature and correspondingly its bound-water vapor pressure. Both processes operate in nature, sometimes augmenting and sometimes opposing each other.

As drying progresses toward lower moisture-content values, a vapor pressure gradient is established within the fuel. The external vapor pressure needed to maintain this gradient must therefore be quite low. Under these conditions, molecular diffusion into the atmosphere is more rapid than that within the fuel. This results in a lesser and lesser tendency for thin layers of higher vapor pressure to form at the fuel surface. For this reason, the effect of wind speed on drying gradually decreases at moisture levels progressively below fiber saturation. The effect may never be eliminated, but at low moisture levels it has little practical significance.

Concept of Moisture Equilibrium

Moisture equilibrium has meaningful application to forest-fuel moisture only in the range of moisture-content values between about

2 percent and fiber saturation. This is the range covered by the falling-rate period of drying. Fuel will either gain or lose moisture within this range according to the relative states of the fuel and its environment. The amount, rate, and direction of moisture exchange depend on the gradient between the vapor pressure of the bound water and the vapor pressure in the surrounding air. If there is no gradient, there is no net exchange, and a state of equilibrium exists.

The equilibrium moisture content may be defined as the value that the actual moisture content approaches if the fuel is exposed to constant atmospheric conditions of temperature and humidity for an infinite length of time. The atmospheric vapor pressure is dependent upon the temperature and moisture content of the air. The vapor pressure of the bound water in fuel depends upon the fuel temperature and moisture content.

Assuming that the fuel and the atmosphere are at the same temperature, then for any combination of temperature and humidity there is an equilibrium fuel-moisture content. At this value, the atmospheric vapor pressure and the vapor pressure of the bound water are in equilibrium. This point almost, but not quite, exists in nature. Small vapor-pressure differences can and do exist without further moisture exchange. This is demonstrated by the fact that a dry fuel in a more moist environment reaches equilibrium at a lower value than a moist fuel approaching the same equilibrium point from above. For this reason also, reduction of humidity to zero does not reduce fuel moisture to that value. Vapor exchange involving bound water is not as readily attained as is free water and atmospheric vapor exchange. At low vapor-pressure gradients involving bound water, there is not sufficient energy at normal temperatures and pressures to eliminate these small gradients.

Equilibrium moisture content has been determined in the laboratory for numerous hygroscopic materials, including a variety of forest fuels. The usual procedure is to place the material in an environment of constant temperature and humidity, leaving it there until the moisture content approaches a constant value. The process is then repeated over the common

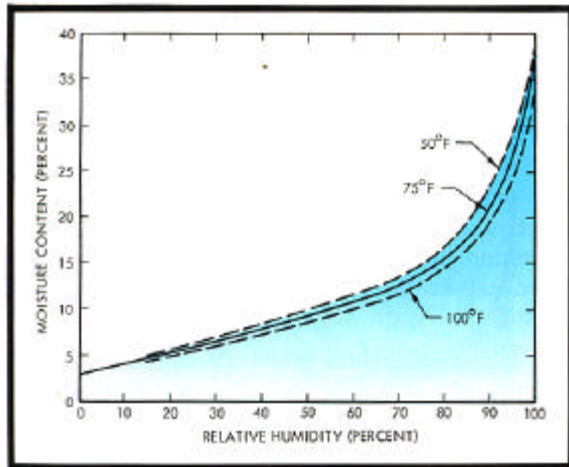

The equilibrium moisture content—the average for six fuel types is shown—depends mainly upon the relative humidity, and to a lesser extent on temperature.

ranges of humidity and temperature encountered in nature. Continuous or periodic weighing shows the changing rates at which equilibrium is approached from both directions. Different fuel types usually have different equilibrium moisture contents, but for most fire-weather purposes it is satisfactory to use the average determined for a number of fuels.

The rates at which moisture content approaches the equilibrium value vary not only with the kind of fuel material, but with other characteristics such as fuel size and shape, and the compactness or degree of aeration of a mass of fuel particles. For any one fuel particle with a moisture content below fiber saturation, the rate of wetting or drying by vapor exchange is theoretically proportional to the difference between the actual moisture content and the equilibrium moisture content for the current environmental conditions.

This means, for example, that when actual fuel moisture is 10 percent from its equilibrium value, the rate of increase or decrease is 10 times as rapid as if the moisture were within 1 percent equilibrium. This relationship indicates that moisture content approaching equilibrium follows an inverse logarithmic path.

Use of the equilibrium moisture-content concept makes it possible to estimate whether fuel moisture is increasing or decreasing under a particular environmental situation, and the relative moisture stress in the direction of equilibrium. This

by itself, however, is a poor indicator of the quantitative rate of moisture-content change. To it, we must also add the effect of size or thickness of the fuel in question.

Timelag Principle

One method of expressing adsorption and drying rates based on both equilibrium moisture content and fuel characteristics makes use of the timelag principle, common to a variety of natural phenomena. According to this principle, the approach to equilibrium values from moisture contents either above or below equilibrium follows a logarithmic rather than a straight-line path as long as liquid water is not present on the surface of the fuels.

If a fuel is exposed in an atmosphere of constant temperature and humidity, the time required for it to reach equilibrium may be divided into periods in which the moisture change will be the fraction $(1-1/e) \approx 0.63$ of the departure from equilibrium. The symbol, e , is the base of natural logarithms, 2.7183. Under standard conditions, defined as constant 80°F. temperature and 20 percent relative humidity, the duration of these time periods is a property of the fuel and is referred to as the timelag period. Although the successive time-lag periods for a particular fuel are not exactly equal, the timelag principle is a useful method of expressing fuel-moisture responses if average timelag periods are used.

To illustrate the moisture response, let us assume that a fuel with a moisture content of 28 percent is exposed in an environment in which the equilibrium moisture content is 5.5 percent. The difference is 22.5 percent. At the end of the first timelag period, this difference would be reduced 0.63×22.5 , or about 14.2 percent. The moisture content of this fuel would then be $28 - 14.2$, or 13.8 percent. Similarly, at the end of the second timelag period the moisture content would be reduced to about 8.6 percent, and so on. The moisture content at the end of five or six timelag periods very closely approximates the equilibrium moisture content.

The average timelag period varies with the size and other factors of fuels. For extremely fine fuels the average period may be a matter of

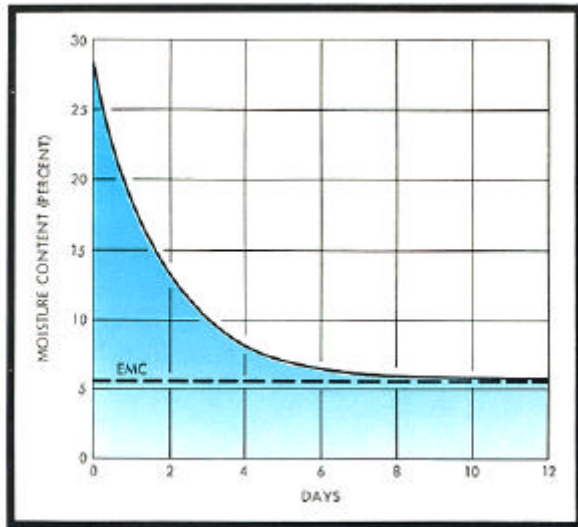

Drying curve of 2-inch layer of litter in an environment for which the equilibrium moisture content is 5.5 percent.

minutes, while for logs it ranges upward to many days. Using the timelag principle, we can describe various fuels—irrespective of type, weight, size, shape, compactness, or other physical features—as having an average timelag period of 1 hour, 2 days, 30 days, and so on. Dead branchwood 2 inches in diameter, for example, has an average timelag period of about 4 days. Logs 6 inches in diameter have an average timelag period of about 36 days. A 2-inch litter bed with an average timelag period of 2 days can be considered the equivalent, in moisture response characteristics, of dead branchwood (about 1.4 inches in diameter) having a similar timelag period if there is no significant moisture exchange between the litter and the soil.

Thus far we have been discussing the moisture behavior of homogenous fuel components exposed to uniform atmospheric conditions. These conditions are never uniform for long. Except for very fine material, it is rare that even one component is really near equilibrium. Most wildland dead fuels consist of such a variety of components that it is impossible for the whole fuel complex to be at equilibrium moisture content at any one time. Nevertheless, a working knowledge of equilibrium moisture-content processes and fuel timelag differences permits one to make useful estimates of current fuel-moisture trends.

Aerial and Ground Fuels

Two types of dead fuel are of particular interest. Dead foliage, twigs, and branches still attached to living vegetation or otherwise suspended above ground respond to precipitation and subsequent atmospheric conditions mainly as individual components according to their respective kinds and sizes. Detached components, forming more-or-less prone fuel beds on the forest floor, often undergo much more complex fuel-moisture changes.

Types of forest floor coverings vary widely depending on the nature of the forest and climatic region. In areas of rapid decomposition, the surface may be covered with only 1 or 2 year's accumulation of dead foliage and a few twigs. At the other extreme, there may be many years of accumulated foliage, branches, and logs consisting of all degrees of preservation and decay from the top downward to, and mixed with, the mineral soil. There is tremendous variety between these extremes. The common feature of all, however, is that only the upper surface is exposed to the free air while the lower surface is in contact with the soil.

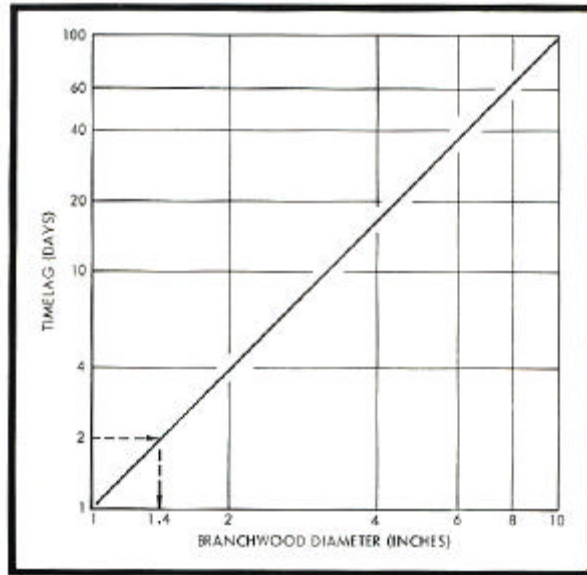

The average timelag period of branchwood and logs varies with the fuel diameter. Other fuels may be compared with these. A 2-inch litter bed with an average timelag period of 2 days, for example, may be considered the equivalent of 1.4-inch dead branchwood having the same average timelag period.

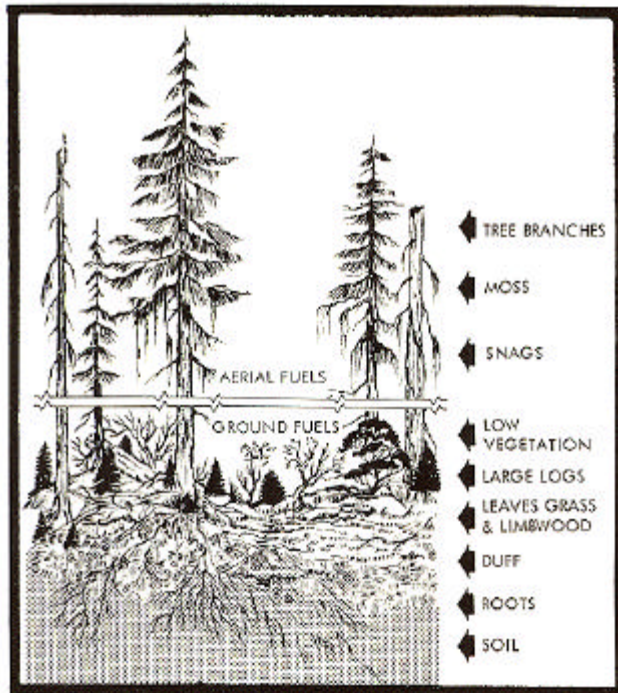

Aerial fuels respond to precipitation and atmospheric conditions as individual components, according to their respective kinds and sizes. Fuels on the ground tend to become compacted and have more complex moisture changes.

There is one moisture gradient between the fuel and the air, another between the fuel and the soil, and still another between the top and bottom of the fuel bed itself. In deep and compact fuel beds, air circulation in the lower layers may be nearly nonexistent. Precipitation soaking down through the fuel into the soil may then produce relative humidities near 100 percent at the lower levels, and this can persist for appreciable times. Subsequent drying starts at the top and works downward. In deep fuels, it is not uncommon for the surface layer to become quite flammable while lower layers are still soaking wet. Here, the moisture gradient is upward.

Reverse gradients also occur after prolonged drying, resulting in the topsoil and lower duff becoming powder dry. Then morning dew on the surface, high relative humidity, or a light shower may cause a downward moisture gradient.

These changes in upward and downward moisture gradients are common in most compacted fuel beds. In some situations, they may even be part of the diurnal cycle of moisture

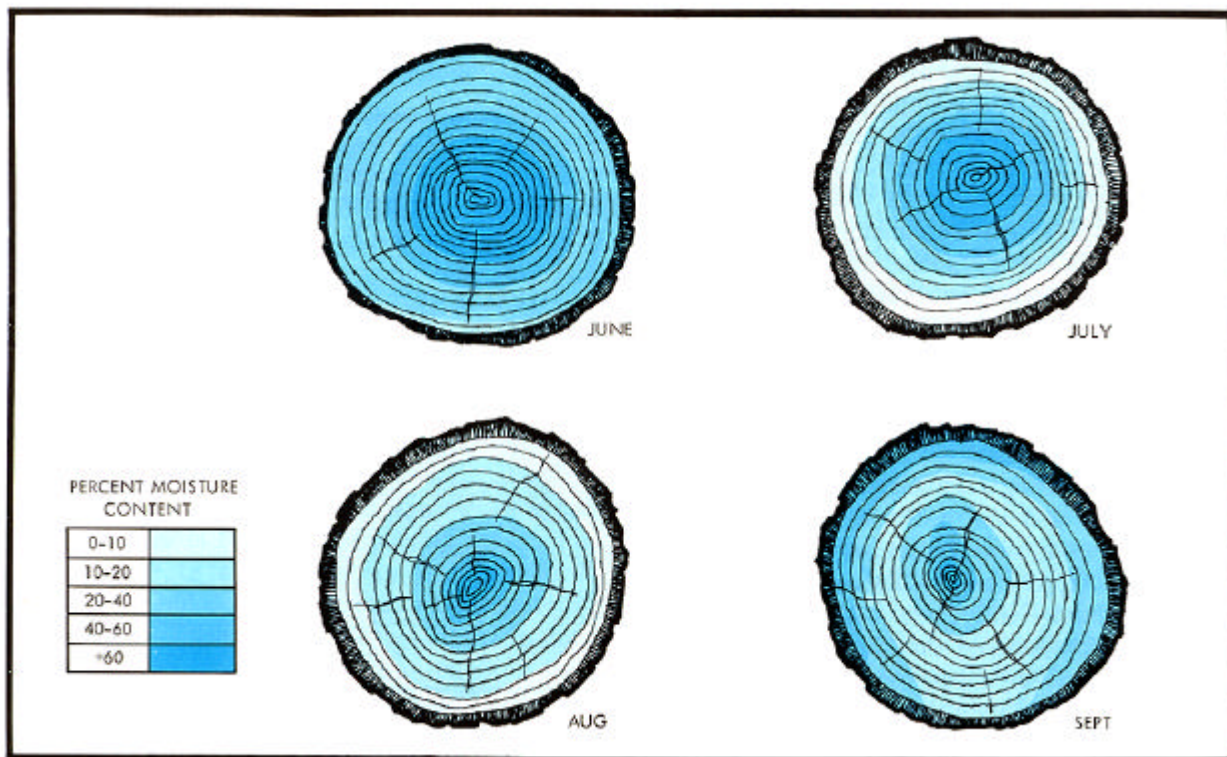

A large log, wet from winter precipitation, dries through the summer from the outside in. In the fall, as rains begin and temperatures and humidities moderate, the process is reversed and the log begins to take on moisture from the outside in.

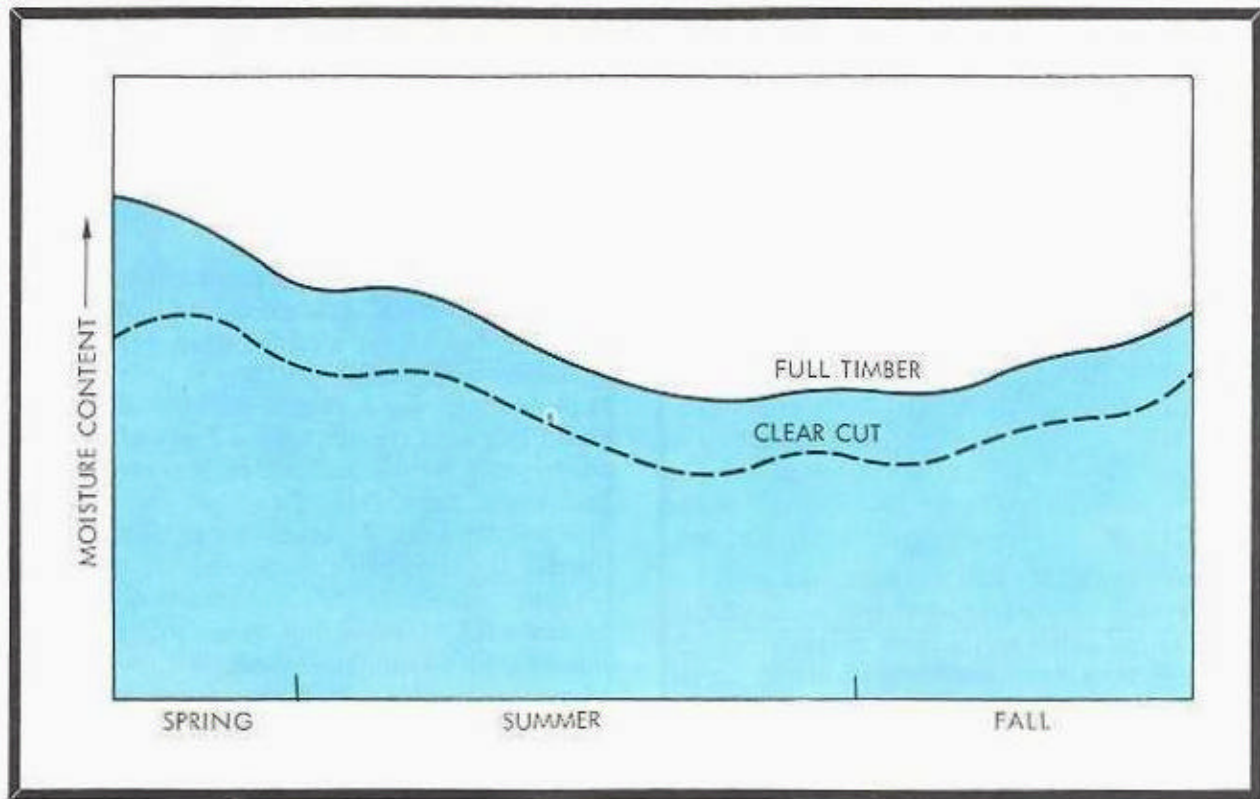

Logs under a forest canopy remain more moist through the season than those exposed to the sun and wind. These curves are 13 – year averages for large logs of 6-, 12-, and 18-inch diameters.

Change in response to diurnal changes in temperature and relative humidity. This is particularly true in open forest stands where much of the surface litter is exposed to direct radiant cooling to the sky at night.

The amount of fuel available for combustion is often determined by these interior moisture gradients. In some cases, for example, fire may only skim lightly over the surface; in others, the entire dead-fuel volume may contribute to the total heat output of the fire.

Effects of Canopy, Clouds, Exposure, Elevation, Wind

During clear weather, fuel-bed surfaces exposed to full midday sun may reach temperatures as high as 160°F. or more. Not only does this greatly increase the bound-water vapor pressure, but it also warms the air near the surface and reduces relative humidity. The combination often results in surface fuel moistures 4 to 8 percent below those in adjacent shaded areas.

Similarly at night, cooling of these exposed fuel surfaces may cause dew to form on them, while it does not form under the tree canopy. Surface fuel moistures and accompanying changes in moisture gradients are thus commonly much greater, and at the same time much more spotty, in open forest stands than under forests having closed-crown canopies. Clouds also tend to reduce the diurnal extremes in fuel moisture.

North-facing slopes do not receive as intense surface heating as level ground and south exposures, so they do not reach the same minimum daytime moistures. The highest temperatures and lowest fuel moistures are usually found on southwest slopes in the afternoon. In mountain topography, night temperatures above the nighttime inversion level ordinarily do not cool to the dew point; therefore, surface fuel moistures do not become as high as those at lower elevations.

Earlier in this section, we emphasized the effect of wind on fuel drying by preventing a

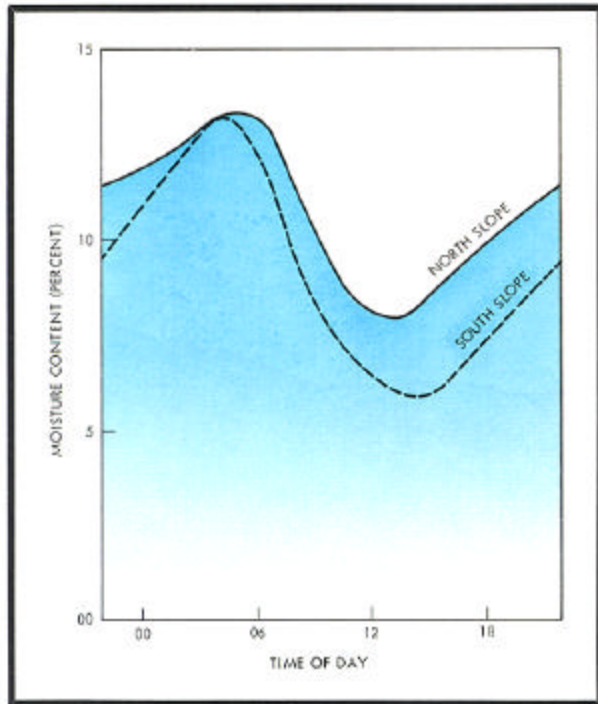

Fuel moistures are affected by aspect. Except for the early morning hours, fuel moistures will be lower throughout the day on south slopes than on north slopes. Southwest slopes usually have the lowest afternoon fuel moistures.

rise in vapor pressure adjacent to the fuel. But moderate or strong winds may affect surface temperatures of fuels in the open and thereby influence surface fuel moisture. During daytime heating, wind may replace the warm air layers immediately adjacent to fuel surfaces with cooler air. This in turn raises the relative humidity in that area and lowers the fuel-surface temperature. Fuel drying is thereby reduced. At night, turbulent mixing may prevent surface air temperatures from reaching the dew point, thus restricting the increase of surface fuel moisture.

Foehn winds are frequently referred to as drying winds because they are so often accompanied by rapid drying of forest fuels. In the case of the foehn, it is warm and extremely dry air that is responsible for desiccation. The important role of the wind here is to keep that warm, dry air flowing at a rapid rate so that it does not become moist by contact with the surface either by day or night. The reverse is true, of course, when moist winds blow over dry fuels. They bring in a continuous supply of moisture to maintain a

pressure gradient favorable for fuel-moisture increase. In all of these moisture-exchange processes, it should be remembered that wind has quite varied and complex effects on fuel-moisture regimes.

Slash

Slash from thinning or harvest cutting of coniferous forests is a special and often particularly hazardous kind of dead fuel. Often, it is flammable from the time it is cut, but it is particularly hazardous if added to significant quantities of flammable dead fuels already on the ground. As the slash dries, it becomes more and more flammable. The slash of different species dries at different rates, and within species the drying rates depend on degree of shading, season of cutting, weather, and size of material. Needles and twigs dry faster on lopped than on unlopped slash. Within a matter of weeks, however, it is not necessary to consider slash needle and twig moisture different from that of older dead fuels. Stems, of course, require longer periods of seasoning to approach the fuel moisture of their older counterparts.

Estimating Dead Fuel Moisture

The moisture content of dead fuels cannot be measured conveniently in the field. For fire-control purposes, it is usually estimated indirectly by various methods. Very fine, dead fuels such as cured fine grass, certain lichens and mosses, well-aerated needles and hardwood leaves, and the surface layer of larger fuels may be in approximate equilibrium with their immediate environments. Except after rain, a reasonably accurate estimate of their moisture content, and therefore their flammability, may be obtained from the equilibrium moisture content corresponding to the immediately surrounding air temperature and humidity. But, even here, it helps to know whether the moisture content is rising or falling.

A method used in some regions to estimate the moisture content of medium-sized fuels is to determine the moisture content of fuel-moisture indicator sticks. A set of sticks consists of four 1/2-inch ponderosa pine sapwood dowels spaced 1/4 inch apart on two 3/16-inch dowels. The 1/2-inch dowels are approximately 20 inches long. Each set is carefully adjusted

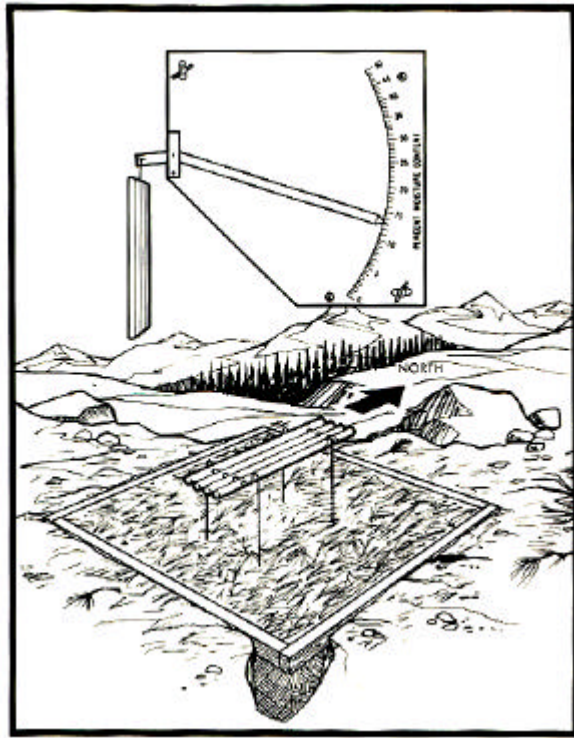

Fuel-moisture indicator sticks of the 1/2-inch size are used to estimate the moisture content of dead fuels of comparable size. They are exposed on a wire rack 10 inches above a bed of litter. By weighing them, their moisture content can be obtained.

to weigh 100 grams when oven-dry. The sticks are exposed 10 inches above a litter bed in the open on wire brackets. They are weighed at least once every day, and their moisture contents are computed from their known dry weights. Scales calibrated to read directly in percent moisture content are available.

The indicated moisture represents the cumulative effects of past changing weather factors on these standardized fuel simulators over a period of time preceding the observation. These indicated values may be modified by current weather or other factors when necessary to more closely approximate actual field conditions. Other systems and devices may also be used as weather integrators in lieu of moisture indicator stick weights.

The moisture content of larger fuels is usually estimated from systematic observations of precipitation and some indicator of daily drying conditions, such as maximum temperatures and day length, or the moisture-content trends of indicator sticks referred to above. From empirical relationships involving amounts of precipitation, number of days without precipitation, and daily drying conditions, the moisture content of large fuels can be estimated.

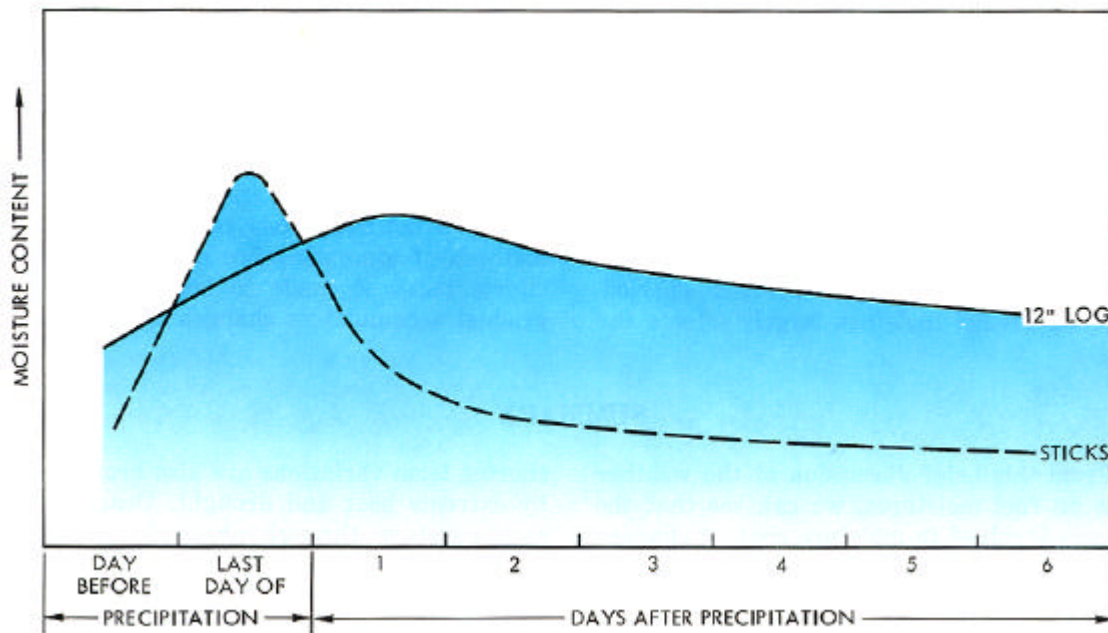

Measurements of the moisture contents of different sizes of fuels before, during, and after precipitation show that larger fuels, such as logs, are slow to react to both wetting and drying.

MIXTURES OF LIVING AND DEAD FUELS

We have noted that somewhat different processes govern the changes in moisture contents of living plant foliage and those of dead forest fuels. It is also significant that the upper flammability limit of most dead fuels under ordinary field conditions is about 25-30 percent moisture content. The living foliage of many evergreen trees and shrubs may burn well with moisture contents of over 100 percent, probably because of volatile oils released, but usually some intermixed dead fuels are necessary to maintain combustion. The different moisture contents in intermixed living and dead fuels do not always rise and fall in the same pattern. They must be evaluated separately to determine the flammability of the complex as a whole at any given time.

The manner in which living and dead fuel mixtures may augment or oppose each other depends somewhat on the nature of the local fire weather in relation to the growing season. A brief dry spell during a period of new leaf development and growth may cause intermixed dead fuels to become reasonably dry. They do not burn briskly, however, because much of the heat needed for fire propagation is absorbed by the succulent foliage. If such a dry spell occurs after the foliage reaches maturity, or when the foliage is dormant, flammability of the complex may become high to extreme.

Areas with a distinct summer dry season tend to have a more or less regular seasonal pattern of foliage and dead-fuel moisture variation. In such areas, it is common for foliage moisture to start increasing about the time dead fuels begin to dry, reaching a maximum in late spring or early summer. During this period, increasing foliage

moisture largely offsets the effects of continued drying of the associated dead fuels. By mid or late summer, however, the foliage has reached the flammability point. Beyond this time, continued foliage moisture decreases, coupled with seasonal cumulative drying of larger dead fuels and deep litter beds, produce increasing flammability until fall rains begin.

Differences among species, total and relative amounts of living and dead fuels, their interrelationships in space, as well as vagaries in weather and growing seasons, occur in infinite variety. Hence, evaluation of the current flammability of most live-dead fuel complexes requires local appraisal and interpretation based on experienced judgment.

One of the most difficult situations to evaluate is that brought about by drought resulting from consecutive years of deficient precipitation. Such periods of persistent drought occur in all forest regions at irregular intervals, often many years apart. Both living and dead fuels are adversely affected. Both old and new living foliage will be abnormally deficient in moisture. The ratio of attached dead twigs and branches will increase markedly. Large logs may become dry enough to burn to a white ash residue. Stumps and their roots may become dry enough to burn deep into the ground. Thus, the flammability of both living and dead fuels will increase, and at the same time the ratio of dead to live fuel increases. The gradual trend in rising fire danger is subtle, but it has a pronounced accumulative effect. This slow trend usually is not adequately recognized by routine methods of computing fire danger, and special efforts must be made to keep aware of the gradual accumulative changes in flammability.

SUMMARY

From this brief discussion of the weather effects on fuel moistures, we can see that the processes involved in moisture content changes are very complex. Living plants and dead fuels respond quite differently to weather changes. The moisture content of a living plant is closely related to its physiology. The major variations in moisture are seasonal in nature, although shorter term

variations are also brought about by extreme heat and drought. Dead fuels absorb moisture through physical contact with liquid water such as rain and dew and adsorb water vapor from the atmosphere. The drying of dead fuels is accomplished by evaporation.

Under suitable drying conditions, first the free water in the cellular spaces evaporates;

then the bound water held to the cell walls evaporates and is absorbed by the atmosphere. The nature of the drying and wetting processes of dead fuels is such that the moisture content of these fuels is strongly affected by weather changes. These moisture contents are influenced by precipitation, air moisture, air and surface temperatures, wind, and cloudiness, as well as by

fuel factors such as surface to volume ratio, compactness, and arrangement.

We have now completed our discussion of the individual fire-weather elements and their effect on the moisture content of forest fuels. In the final chapter, we will learn how fire weather varies from one region to another over the North American Continent.

FIRE CLIMATE REGIONS

The fire weather occurring on a particular day is a dominant factor in the fire potential on that day. Fire climate, which may be thought of as the synthesis of daily fire weather over a long period of time, is a dominant factor in fire-control planning. Climatic differences create important variations in the nature of fire problems among localities and among regions. In a broad sense, climate is the major factor in determining the amount and kind of vegetation growing in an area, and this vegetation makes up the fuels available for wild-land fires. Climate sets the pattern of variation in the fire-protection job—seasonally and between one year and another. It establishes the framework within which current weather influences fire-control operations.

Knowledge of the similarities, differences, and interrelationships between regional weather patterns becomes a useful daily fire-control management device. A weather pattern that is significant to fire behavior in one region may be unimportant in another. What is unusual in one region may be commonplace in another. On the other hand, many large-scale weather patterns ignore regional boundaries, and one originating in or penetrating a region may then be a forewarning of what is soon likely to happen in neighboring regions. Fire-control personnel in line and staff positions who are transferred, either temporarily or permanently, to a new region will find this knowledge helpful in adapting to the changed environment. Understanding of regional fire climatology is critically essential to effective information exchange up to the international level, and it is vital to the continuing development of fire-control lore.

FIRE CLIMATE REGIONS

The fire climate of a region is the composite or integration over a period of time of the weather elements which affect fire behavior. Because of the nature of the effects of various weather elements on fire behavior, simple averages of the weather elements are of little control value. Two areas may have the same annual mean temperature, let us say 50°F., but one of the areas may have monthly mean temperatures ranging from 20 to 80°F., while the other may have monthly means ranging only from 40 to 60°F. The first area may have a serious fire problem during the warm months; the other may not. The extremes of temperatures within months may also be an important consideration.

In a similar situation, two areas may have the same annual precipitation. But the amount may be evenly distributed throughout the year in one area, and concentrated during one portion of the year in the other area. The seasonal distribution, the extremes, the frequency, and the duration must all be considered in describing precipitation in the fire climate of a region.

Fire climate cannot be described by considering the weather elements individually. Fire potential responds to the combined effects of all of the fire-weather elements. In the precipitation example given above, it makes considerable difference in fire climate whether or not the precipitation is concentrated in the warm season or the cold season of the year. If it is concentrated in the cold season, and the warm season is dry, the fire potential during the warm season may be extreme. Where the reverse is true, the warm season may have little fire potential, while the most critical periods may be in spring and fall. Strong winds are very important in fire behavior, providing they occur in dry weather. A region may often have strong winds, but if they occur with precipitation, they are of much less importance to the fire climate.

Fire-danger rating is an integration of weather

elements and other factors affecting fire potential. In many systems, only the weather elements are considered, because they are the most variable. The principal elements incorporated are wind speed, temperature, and estimates of dead-fuel moisture, which may be obtained from the atmospheric humidity or dew point, from precipitation measurements, from fuel-moisture indicator sticks, or combinations of these or other integrating systems. Green-fuel moistures may be included by estimating the curing stage of lesser vegetation or the maturity of brush foliage. Daily fire-danger rating is dependent on current fire weather, while seasonal and average fire-danger ratings are dependent on the fire climate.

In studying fire climate, it is necessary to keep in mind that one of the most important behavior characteristics of weather is its variation with time. Thus, we need to know much more than the computed averages of past weather measurements. Normal rainfall, for example, may be an interesting bit of information, but this tells us little about the fire potential unless we know when the rain falls, the kind of weather accompanying it, the weather between rains, the frequency of drought and wet periods, and similar details.

The areas of North America in which wild-land fires are a problem have a wide variety of fire climates. Latitude alone accounts for major changes from south to north. These latitudes range from about 20°N. to nearly 70°N. The shape of the continent, its topography, its location with respect to adjacent oceans, and the hemispheric air circulation patterns also contribute to the diversity of climatic types.

We will consider first, in a general way, the geographical features of North America, the pressure and general circulation affecting this continent, and the temperature and precipitation patterns. Then we will discuss the fire climate in each of 15 regions of North America.

GEOGRAPHICAL FEATURES OF NORTH AMERICA

The Interior

The extent of the North American Continent in both its north-south and east-west dimensions permits the full development of continental air masses over much of the land area. The continent is also surrounded by water and is invaded by various maritime air masses. How both types combine to influence the North American climate is largely determined by the surface configuration of the land mass.

It is particularly important that only about a quarter of North America is covered by significant mountain topography. Furthermore, all the mountains lie on the far western side of the continent except two mountain chains along the Atlantic and Gulf of Mexico seaboard. These two chains are the **Appalachian Mountains** in the United States and the **Sierra Madre Oriental** in Mexico. It is also important that, with the exception of the Brooks and associated ranges enclosing interior Alaska and adjoining Canada, all of the major mountain systems have a north-south orientation.

The entire west coast is rimmed by a series of coastal ranges extending, with only infrequent interruptions, from southern Lower California to southern Alaska. A narrow coastal plain separates the mountains from the sea over most of this coastline from Mexico to southern British Columbia. From there northward, the Coast Mountains more commonly rise abruptly from near the water. Glaciers are common along the Canadian and Alaskan coasts, increasing in number northward.

Two disconnected interior ranges in the Far West have additional influences on climate. The **Sierra Madre Occidental** in Mexico, east of the Gulf of California, is a secondary range largely shielded from direct Pacific influence by the mountains of Lower California. South of the tip of Lower California, it becomes the mainland western coast range of Mexico. The **Sierra-Cascade Range**, beginning in the north portion of southern California, parallels the Coast Range up to the Fraser River in southern British Columbia. This range bounds the east side of California's Central

Valley and a succession of coastal valley systems through Oregon and Washington. It is somewhat higher than the Coast Range, including several peaks in excess of 14,000 feet in elevation.

The **Rocky Mountain system** forms the backbone of that portion of the continent lying in Canada and the United States. It is the continent's most massive mountain expanse and forms the **Continental Divide**, separating water that flows to the Pacific from that flowing to all other surrounding waters. The mountains extend from the Arctic Ocean west of the Mackenzie River to northern New Mexico. The Sierra Madre Occidental plays a similar role in Northern Mexico.

The vast intermountain region west of the Rocky Mountains and northern Sierra Madre is known as the **Cordilleran Highlands**. From a narrow beginning in northern British Columbia, it extends southward in a generally broadening belt to Northern Mexico, where it becomes the Mexican Plateau, and diminishes in width farther south. In the United States a large part is called the Great Basin. The region, as its name implies, is upland country. Because of both topographic and latitudinal differences, however, there are some sub-regional characteristics that are also important to the climatology of the region as a whole. We will note them in some detail later in this chapter.

East of the Rocky Mountains, all of Canada and parts of the Northern United States were scraped and gouged by the prehistoric Polar Ice Cap. This left a land of many lakes and low relief covered mostly by glacial till and numerous moraines. This glaciated region extends into, and connects with, the broad Mississippi Valley system and the adjoining Great Plains—which slope upward to the foot of the Rocky Mountains from Southern Canada to Texas.

East of the Rocky Mountains, therefore, the Appalachian Mountains represent the only topographic barrier on the continent that has a significant influence on general air circulation. It is particularly noteworthy that there is no such barrier between the Arctic and the Gulf of Mexico.

The interiors of Canada and Alaska are source regions for continental polar air and are

protected from maritime influence by the western mountain chains. Upon leaving the source regions, this cP air can penetrate far to the south because of the absence of any major east-west mountain ranges across the continent. The southflowing cold air is channeled between the Rocky Mountain system and the less formidable Appalachian Mountains. It often reaches and sometimes crosses the Gulf of Mexico. The lack of mountain barriers also allows warm, moist air from the Gulf of Mexico to flow northward. This warm air constitutes a somewhat deeper layer than the continental air and is less influenced by the mountain systems.

Because of its generally high elevation, the interior of Northern Mexico is little affected by polar continental air. Maritime influence is also restricted. The Sierra Madre Occidental in the west limits the surface effects of Pacific maritime air to the coastal strip. The Sierra Madre Oriental limits the surface effects of Gulf air to the coastal plain. As Mexico's land mass narrows toward the south between the adjacent warm Pacific and Gulf waters, the climate becomes warm and humid.

Influences of the Oceans

The Pacific Ocean has a strong maritime influence on the whole length of the western shore of North America. However, this influence extends inland near the surface for only relatively short distances because of the barriers provided by the Coast, Sierra-Cascade, and the Rocky Mountain ranges in the United States and Canada, and by the Sierra Madre Occidental and Baja California Mountains in Mexico.

The ocean current known as the North Pacific Drift approaches the west coast at the latitudes of

Puget Sound, where it divides. The northern branch becomes the **Alaska Current** and flows northward and then westward along the Alaska coast. The southern branch becomes the **California Current** flowing southward along the west coast. Prevailing westerly winds off the temperate waters of the Pacific have a strong moderating influence along the coast in both summer and winter. The relatively warm waters of the North Pacific are the source of moisture for winter precipitation.

The Bering Sea also contributes some moisture for winter precipitation, while the Arctic Ocean, being largely frozen, is a principal source region for dry polar continental air. The same is true of Hudson Bay during the winter months.

The Atlantic Ocean influences the climate of the east coast, but the effects do not extend far inland because the prevailing air movement is offshore. The icy waters of Baffin Bay have a strong cooling influence on temperatures in Labrador and as far south as Nova Scotia. The Southwest Atlantic, Caribbean Sea, and Gulf of Mexico are important sources of warm, moist air affecting both summer and winter climates of much of the eastern part of the continent. Influences of the warm **Gulf Stream**, which flows northward near the southeast coast, do not ordinarily extend far inland because of the prevailing westerly winds. The wintertime temperature contrasts between the Gulf Stream and the continent create suitable conditions for the development of storms.

The Great Lakes form the only interior water system of sufficient size to have any appreciable effect on regional climate. They have a moderating effect in both winter and summer and contribute some moisture for precipitation in adjacent areas.

PRESSURE AND GENERAL CIRCULATION

The general features of the hemispheric pressure zones and wind circulation patterns were discussed in chapter 5. We will review them briefly here as they affect the North American Continent. Over the oceans the pressure is usually low near the Equator, **high** around 30°N. along the Horse Latitudes (equivalent to Northern Mexico), **low** in

the Polar Front zone around 55° or 60°N. (the latitude of the northern portion of the Canadian provinces), and high in the polar regions.

These pressure zones give rise to: (1) The typical northeast trade winds blowing onshore from the Atlantic and Gulf between the Tropics

and 30°N., (2) prevailing westerlies off the Pacific between 30°N. and the Polar Front zone, and (3) polar easterlies north of the Polar Front zone. As seasonal heating and cooling change, these pressure and wind systems move somewhat north in summer, and south again in winter.

Over the North American Continent the pressure zones are not as persistent as over the adjacent oceans. High-pressure centers tend to develop over land during the winter, and low-pressure centers tend to develop there during the summer. In between summer and winter there are wide variations in circulation over the continent.

The wintertime continental high pressure gives rise to migratory high-pressure centers. These centers move southward at intervals as waves or surges of cold north wind, extending as far south as the Southern States where they meet warmer air along the South Atlantic and Gulf coasts. During the transition from winter

to summer, these high-pressure systems gradually weaken, and the cold north winds do not penetrate far south. By full summer, they are prevalent only in Northern Canada. The Brooks Range in northern Alaska is a local barrier against them in that area.

The Pacific and Azores—Bermuda high-pressure systems, with their clockwise airflow, dominate the summertime wind pattern over large portions of the continent. With the northward movement of the Pacific High during the spring, prevailing winds along the west coast gradually shift from generally southwesterly to northwest and north. The circulation around the Bermuda High is the dominant feature along the Mexican Gulf coast and the Central and Eastern United States.

An intense heat Low in summer in the Southwest influences the general weather pattern in most of the Southwestern United States and Northern Mexico.

TEMPERATURE VARIATIONS

Temperatures vary with the intensity of solar radiation at the earth's surface, among other factors. Because of this, there is a close relationship between average temperatures and latitude. Another major influence on temperature patterns is the distribution of land and water surfaces. At any given latitude, mean temperatures are higher in summer and cooler in winter over land than over water. The annual range of temperature between winter and summer is greater in the interior of the continent than over the adjacent oceans. The blocking effect of the high western mountain ranges also influences the mean temperature pattern.

A third major influence on temperature is elevation because, as we learned in chapter 1, the temperature through the troposphere usually decreases with height. Thus, an area a few thousand feet above sea level may have average maximum temperatures comparable to a low elevation area many hundreds of miles farther north.

A map of the mean winter temperature shows that temperatures are higher along the

east and west coasts than they are in the interior, and higher along the west coast than the east coast. These differences are more marked at higher latitudes than at lower latitudes. In the general west-to-east airflow, the west coast is more strongly influenced by the adjacent ocean than the east coast. In addition, the west coast is sheltered from the cold continental air masses by high mountain ranges.

In January, almost all of the interior of Canada and the Northern United States have mean temperatures below freezing. The coldest temperatures are found in the region between Hudson Bay and northern Alaska. The Great Lakes have a slight moderating effect on the temperature pattern; this area shows slightly higher mean temperatures than points to the east or west.

In the summer, differences in temperatures between the northern and southern sections of the continent are much less than in winter. The effect of the lesser angle of the sun's rays in the northern latitudes is partially offset by the longer days there. The sharp temperature gradient across the Pacific coastline is largely

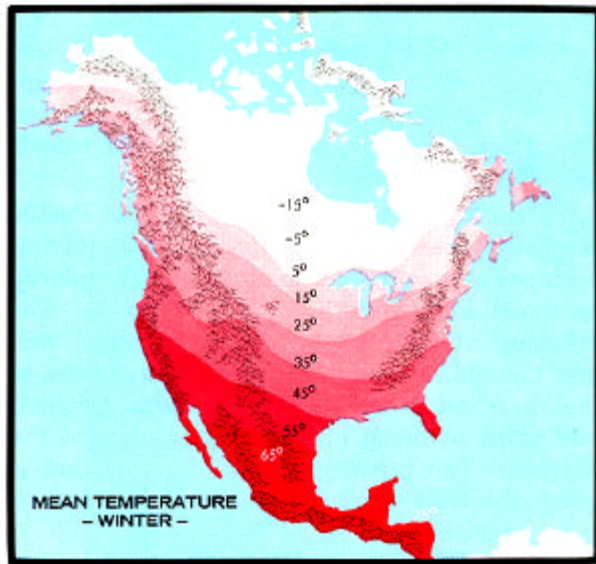

Mean winter temperatures reflect the ocean influence, with higher temperature along the coast than in the interior. The decrease in temperature from south to north is due to latitudinal differences in the sun's inclination and the length of daylight.

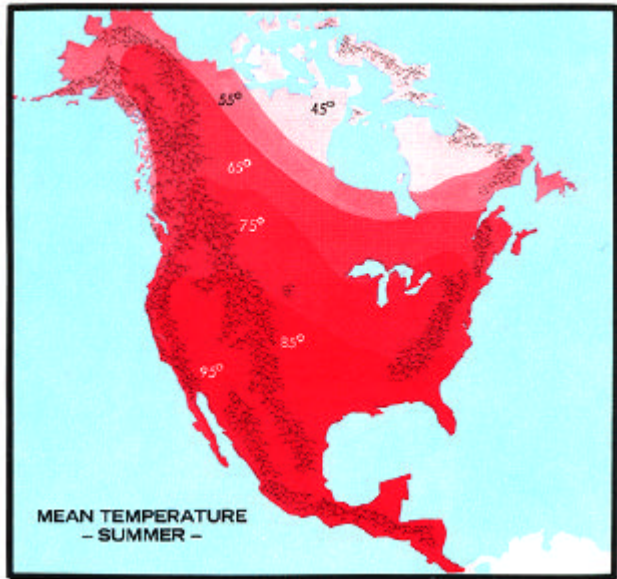

Mean summer temperatures also show the ocean influence with temperatures lower along the coast than in the interior. The effect of latitude is much less pronounced in summer than in winter. Highest temperatures are found in the desert regions of the Southwest.

due to the cool California Current off the coast and the intense daytime heating which is felt, not only in the American Southwest, but also to some extent up through British Columbia and into interior Alaska.

The highest temperatures in summer are found in the lowlands of the Southwest; the

lowest temperatures are found in Northeastern Canada.

In general, autumn temperatures are higher than spring temperatures in North America. There are some exceptions; in Texas and the interior of British Columbia, temperatures are higher in April than in October.

PRECIPITATION PATTERNS

Both annual precipitation and seasonal distribution of precipitation depend on: (1) The moisture content of the air and vertical motions associated with surface heating and cooling, (2) major pressure systems, and (3) frontal and orographic lifting. This lifting has its greatest effect when the prevailing moist wind currents blow across major mountain systems.

In North America, the greatest precipitation is on the Northern Pacific coastal plains and the western slopes of the mountains, due to the influx of moist air from the Pacific Ocean. Maximum fall is on the Pacific Northwest coast of the United States, with amounts decreasing both north and south of this region. The inland valleys receive less

precipitation than the coastal plains and coastal mountains. Along the western slopes of the next major ranges, such as the Sierra-Cascades, further lifting of the moist air again causes an increase in the total precipitation. A third, and final, lifting of these westerlies occurs on the western slopes of the Rocky Mountains, which extract most of the remaining precipitable moisture.

In each of these cases of orographic lifting, there is a decrease in precipitation activity as the air flows across the crests. Previous precipitation has left the air less moist. The lifting force has ceased, and often there is subsidence on the leeward side, which further reduces the



Annual precipitation varies widely over North America. Maximum precipitation is along the Pacific Northwest coast and the Gulf coast. Lowest amounts occur in the Great Basin, the Southwest semidesert and desert regions, and the Arctic region.

degree of saturation. Such a leeward area is said to lie in a rain shadow, a term derived from its similarity to the shadows cast by the

western mountains as the sun goes down. This explains why the inland valleys receive less precipitation than the coastal plains and mountains. The Great Basin area in the United States lies in such a rain shadow, and ranges from semidesert to desert.

East of the Rocky Mountains, air of Pacific origin has become relatively dry, and its importance as a source of precipitation is replaced by moist air from the Gulf of Mexico. The influence of Gulf air extends northward well into Canada. Annual precipitation increases to the east and south under the more frequent intrusions of moist air from the Gulf and the Atlantic. The greatest annual precipitation is along the Gulf coast and the southern end of the Appalachians.

In most areas of the continent, there is considerable variation in annual rainfall. Wet and dry years may occur irregularly in poorly defined patterns, or as wet and dry fluctuations of variable duration. Within any one climatic region, a characteristic variation can usually be identified. Common ones are: Normally moist but with occasional critically dry years; typically dry with only infrequent relief; or longer period fluctuations of alternating wet years and dry years.

The seasonal distribution of precipitation varies widely over the continent and is often as important in fire weather as the total annual amount. We will discuss some of these characteristics region by region in the following section.

FIRE CLIMATE REGIONS

Considering geographic and climatic factors together, it is possible to delineate 15 broad climatic regions over the continent. Most of these differ in one or more aspects, giving each a distinctive character affecting the wildland fire problem. In considering the climatic characteristics of a particular region, we should remember that generalities must be made and that there are many local exceptions.

1. Interior Alaska and the Yukon

The vegetation in this region is predominantly spruce and aspen, with some tundra and other lesser vegetation in the north. The Yukon Basin has a warm, short summer. Continental heating has produced summertime temperatures of 100°F., but temperatures as low as 29°F. also have occurred in July. Winters are extremely cold. The high coastal mountains

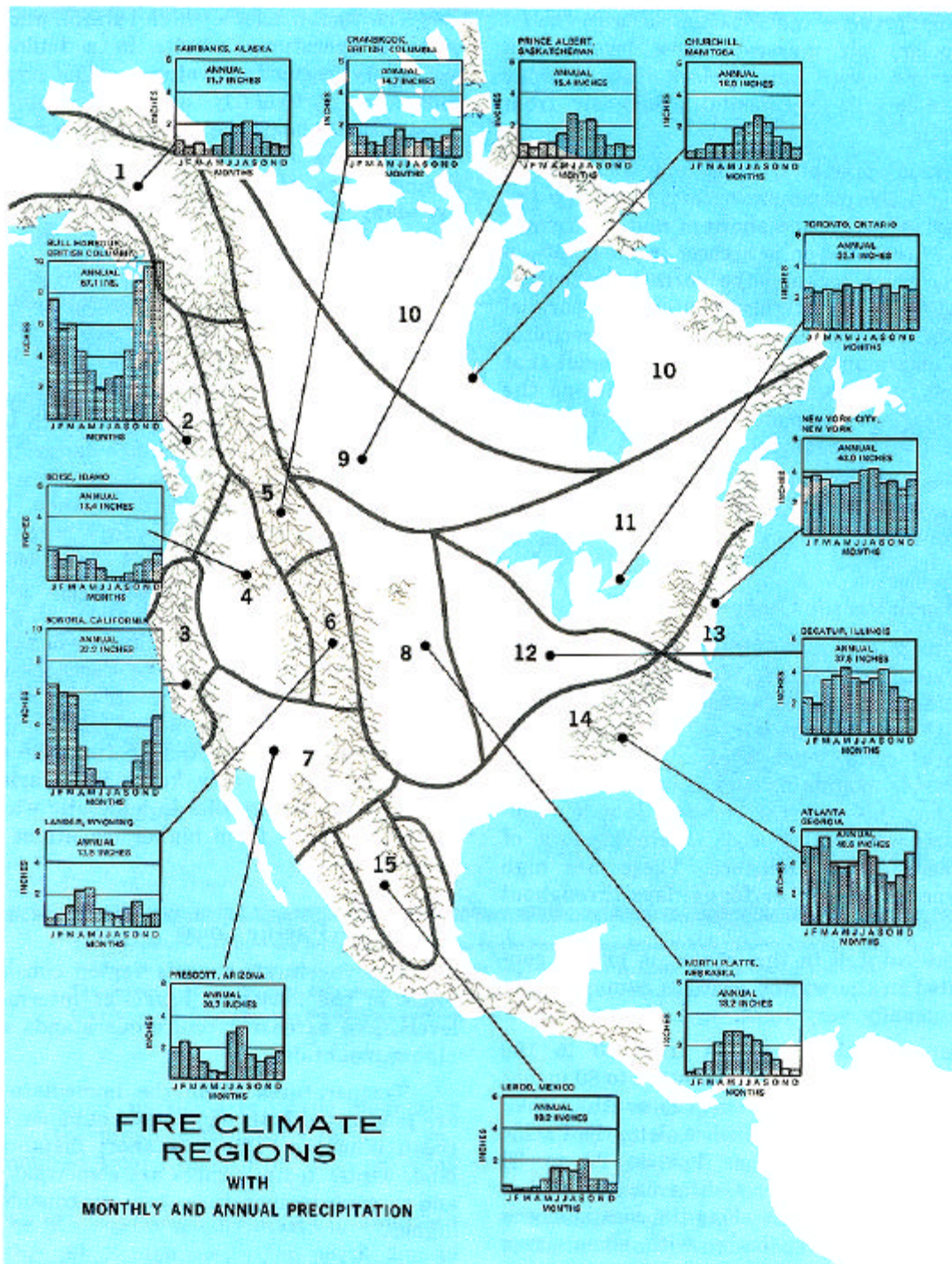

Fire climate regions of North America, based on geographic and climatic factors, are as follows: (1) Interior Alaska and the Yukon, (2) North Pacific Coast, (3) South Pacific Coast, (4) Great Basin, (5) Northern Rocky Mountains, (6) Southern Rocky Mountains, (7) Southwest (including adjacent Mexico), (8) Great Plains, (9) Central and Northwest Canada, (10) Sub-Arctic and Tundra, (11) Great Lakes, (12) Central States, (13) North Atlantic, (14) Southern States, and (15) Mexican Central Plateau. The bargraphs show the monthly and annual precipitation in inches for a representative station in each of the fire climate regions.

generally prevent the invasion of mP (maritime polar) air masses at low levels. The Brooks and other ranges block the inflow of even colder cP (continental polar) air from the north.

Annual precipitation is only about 10 to 15 inches, the maximum occurring during the summer in convective showers and with weak fronts. Precipitation is highest in the southern portion, which includes the northern extension of the Cordilleran Highlands and their parallel chains of lesser mountains. Although precipitation is maximum in summer, it is so scant that wildland fuels dry out considerably during the long, clear, dry summer days. Dry thunderstorms are not infrequent.

The usual fire season starts in May after melting of the winter snows and lasts until September.

2. North Pacific Coast

This is a region of rain-forest types with heavy coniferous stands. Because of the maritime influence, coastal areas are comparatively warm throughout the winter. The lowest temperatures occur when a cP air mass crosses the coastal mountains and covers the Pacific coast, but this is a rare event. Summer temperatures are rather cool, again because of the Pacific Ocean influence. There is a high frequency of cloudy or foggy days throughout the year.

The rainfall in this region is mostly concentrated in the winter months; summer rainfall is usually very light.

Annual rainfall varies from 60 to 150 inches along the coast, averaging 60 to 80 inches along British Columbia and the south Alaska coastal plains, 80 to 100 inches along the Pacific Northwest coast, and as low as 20 to 30 inches in some northern California coastal sections. Many local areas along the coastal slopes have much greater totals, with some areas receiving over 150 inches; in the Olympic Mountains, annual precipitation ranges up to 240 inches. The valley systems to the east of the Coast Ranges receive 12 to 20 inches in British Columbia, 30 to 50 inches in Washington and Oregon, and 15 to 20 inches in northern California.

The combination of high rainfall and moderate temperatures results in a buildup of **extremely heavy fuel volumes**. The maritime influence, particularly along the immediate coast, usually holds the fire danger to moderate levels during most seasons. However, some summers are very dry and warm with high fire danger. During these periods, fires are characterized by high intensities, firewhirls, and long-distance spotting.

The fire season usually runs from June through September. Lightning fires increase in number and severity from the coast inland.

In northern California and in western Oregon and Washington, **strong, dry north to east winds may produce extreme fire danger in late summer and early fall**. Two synoptic weather types produce this critical fire weather. One is a cold-front passage followed by a bulge of the Pacific High extending inland over the coast. The attendant northeasterly winds blowing downslope produce a warming and drying foehn effect. The second type follows when higher pressure develops east of the Cascades at the time a trough lies along the coast. The resulting dry easterly winds will cause high fire danger west of the Cascades. Airflow from the northeast quadrant not only keeps the marine air offshore, but also results in adiabatic warming as the air flows from higher elevations down to sea level.

3. South Pacific Coast

The vegetation in this region consists of grass in the lowlands, brush at intermediate levels, and extensive coniferous stands in the higher mountains.

Temperatures along the immediate coast are moderated both winter and summer by the ocean influence. But only short distances inland, winter temperatures are somewhat lower and summer temperatures average considerably higher.

The annual precipitation is generally light, around 10 to 20 inches at lower elevations. Precipitation in the mountains ranges up to 60 inches or more locally. Summers are usually rainless, with persistent droughts common in southernmost sections. Widespread summer thunderstorms, with little precipitation reaching

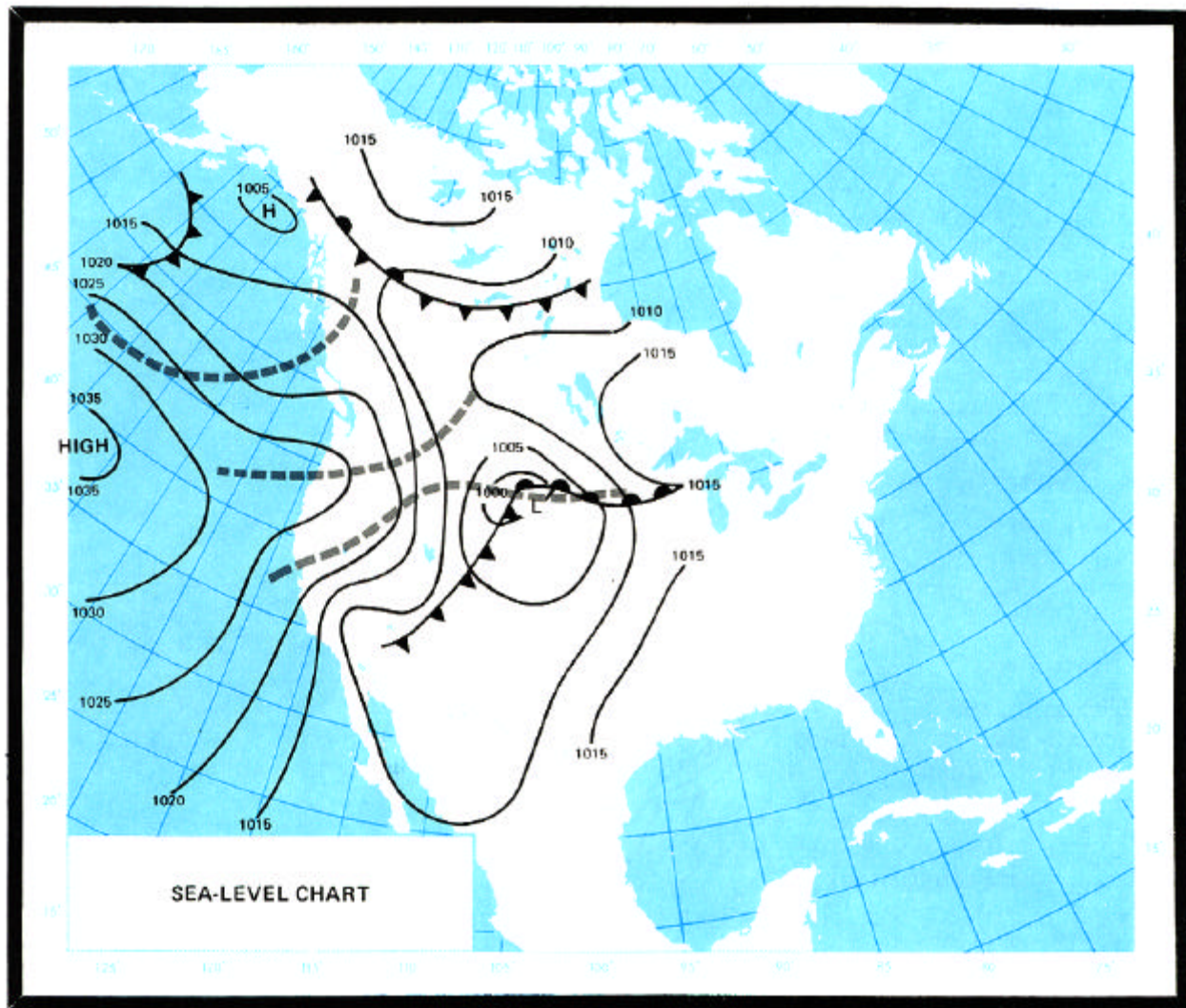

Post-frontal offshore flow can bring high fire danger to the Pacific coast from British Columbia to southern California. The area affected by the pattern on this sea-level chart is northern and central California. The dashed lines are the past daily positions of the front. The bulge of the Pacific High moving inland to the rear of the front produces the offshore northeasterly winds.

the ground, particularly in the mountains of the northern half, occasionally result in several hundred local fires within a 2- or 3-day period.

The fire season usually starts in June and lasts through September in the north, but **in the south critical fire weather can occur year round.**

Several synoptic weather types produce high fire danger. One is the cold-front passage followed by winds from the northeast quadrant—the same as was described above for the coastal region farther north. Another is similar to the east-wind type of the Pacific Northwest coast, except

that the high is farther south in the Great Basin. This Great Basin High type produces the foehn-type Mono winds along the west slopes of the Sierras and Coast Ranges, and the Santa Ana winds of southern California. Peak Santa Ana occurrence is in November, and there is a secondary peak in March. A third high fire-danger type occurs when a ridge or closed High aloft persists over the western portion of the United States. At the surface, this pattern produces very high temperatures, low humidities, and air-mass instability.

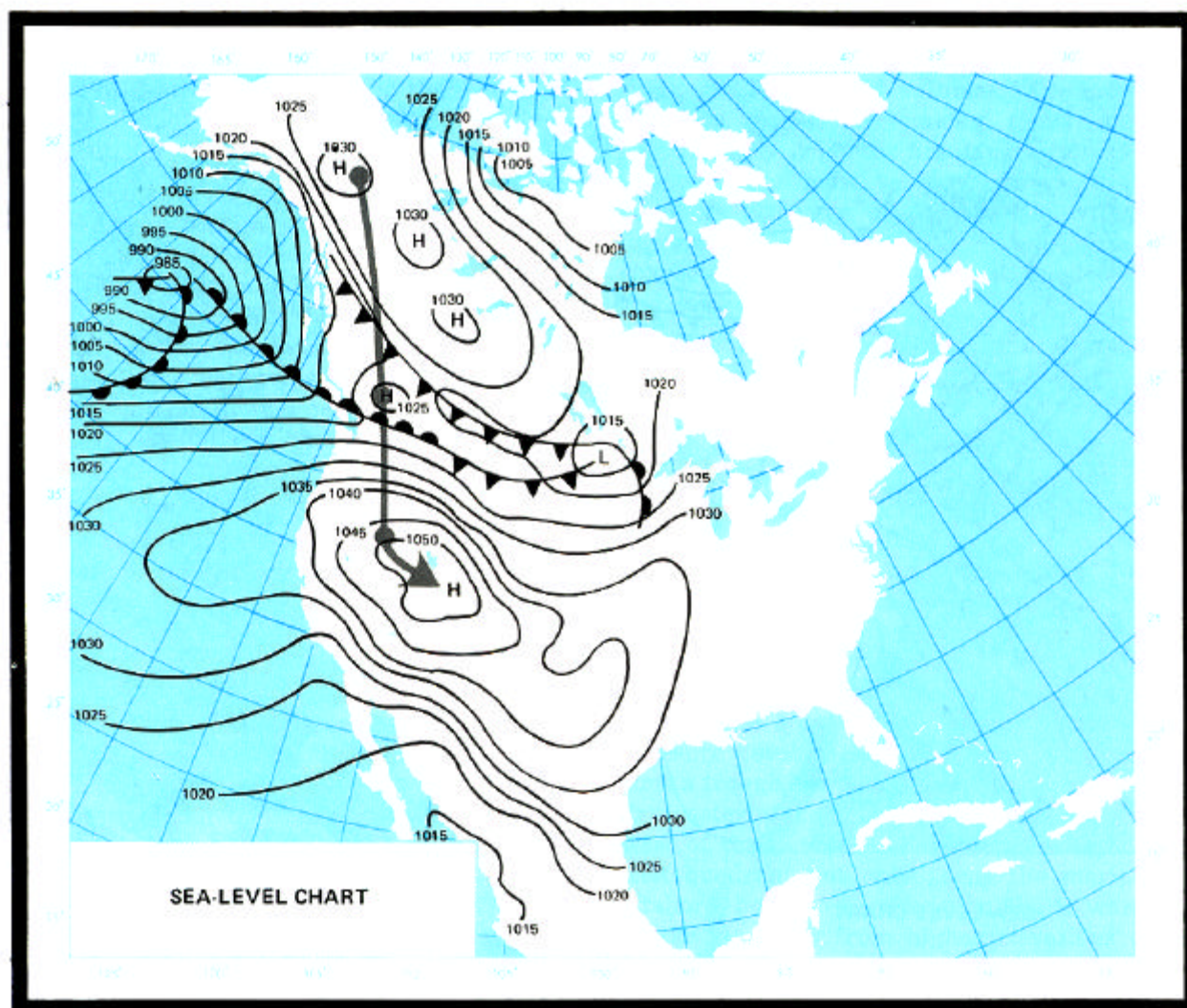

The Great Basin High type develops when a high-pressure center of either mP or cP origin moves into the Great Basin area. If a trough of low pressure lies along the coast, offshore foehn-type winds from the northeast or east are produced. This sea-level chart shows a pattern which produced strong Santa Ana winds in southern California. The track and past daily positions of the High are shown.

4. Great Basin

In the Great Basin or intermountain region the vegetation consists of generally sparse sagebrush and grass, with some pine and fir at higher elevations. This is largely a plateau region but occupies a significant portion of the Cordilleran Highlands, with their individual peaks and lesser mountain systems, between the Rocky Mountains and the Sierra-Cascades.

The Rocky Mountains generally prevent the westward movement of cold cP air masses from the Great Plains to the Great Basin, so major cold

waves with high winds are rare. Winter temperatures are quite low, however, because of the high elevation and good radiational cooling. Summer heating is very effective, and summer temperatures are high.

Annual precipitation is rather low, ranging from 10 to 20 inches in eastern Washington and Oregon and western Idaho to less than 10 inches in Nevada and Utah. At higher elevations, precipitation is higher, generally 20 to 40 inches, as in the Blue Mountains in eastern Oregon and Washington and the Wasatch Range in Utah. The entire Great Basin is in

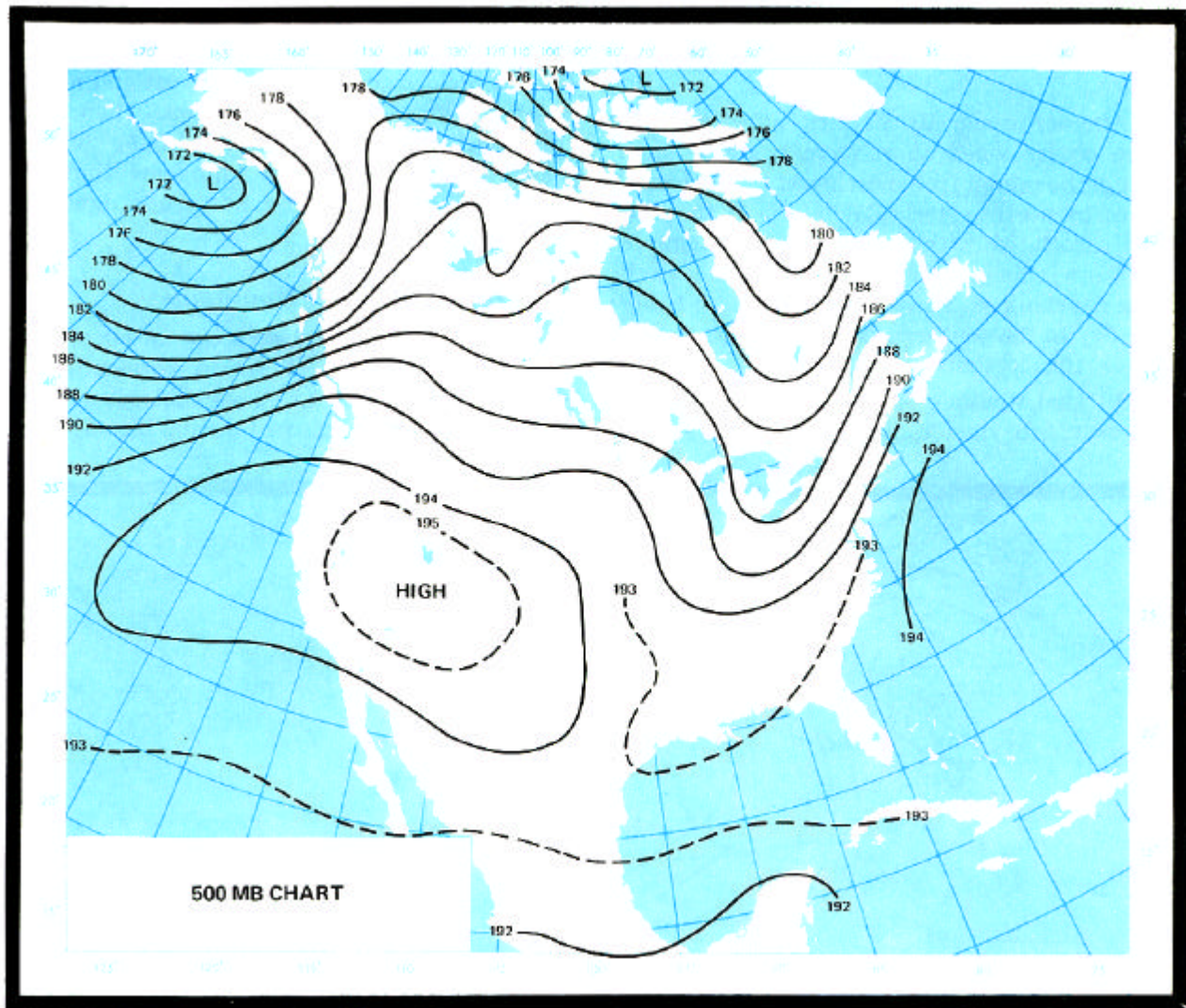

An upper-air pattern associated with high fire danger during the summer in the Western United States has the subtropical High aloft located over the Far West. This pattern, illustrated by this 500-mb. chart, produces very high temperatures, low humidities, and unstable atmospheric conditions near the surface.

a rain shadow. The mP air masses which enter the region from the west have crossed the Sierra-Cascade Ranges and have lost much of their moisture during the forced ascent.

Much of the precipitation occurs in the wintertime, although some areas have a secondary maximum in spring. Precipitation is more general and widespread in winter, while in spring it is showery and scattered. Summer precipitation is generally light. Intensive local heating produces frequent afternoon thunderstorms, but usually little precipitation reaches the ground.

The fire season normally starts in June and lasts through September and, occasionally,

October. Both timber and range fires are common.

Several synoptic weather types produce high fire danger in the Great Basin. Often, the pattern aloft is more distinctive than the surface pattern. One pattern is the same as is described above for the South Pacific coast region; that is, a pattern with an upper-air ridge over the western portion of the United States. At the surface in the Great Basin the pressure pattern tends to be fiat, often with a thermal trough extending from the Southwest to the Canadian border. This pattern produces hot, dry days with considerable low-level, air-mass instability during the summer.

Subsidence beneath the ridge may result in very low humidities that sometimes reach the surface.

Another upper-air pattern affecting this region occurs when short-wave troughs move through the region from northwest to southeast, steered by northwesterly flow aloft. If the cold front associated with a short-wave trough is dry, the windiness with it will produce a peak in the fire danger. These fronts are more likely to be dry in the southern portion of this region than in the northern portion.

A third weather pattern, which is important as a fire starter, develops whenever the anticyclonic

circulation around a closed High aloft has transported moist air from over the Gulf of Mexico across the Southwest and northward into the Great Basin region. Then, daytime heating and orographic lifting of the moist air produces many high-level thunderstorms, which may cause numerous lightning fires.

5. Northern Rocky Mountains

Heavy pine, fir, and spruce stands dominate the Northern Rocky Mountain region. Many mountain peaks extend above timberline. The portion of this region in Canada includes the

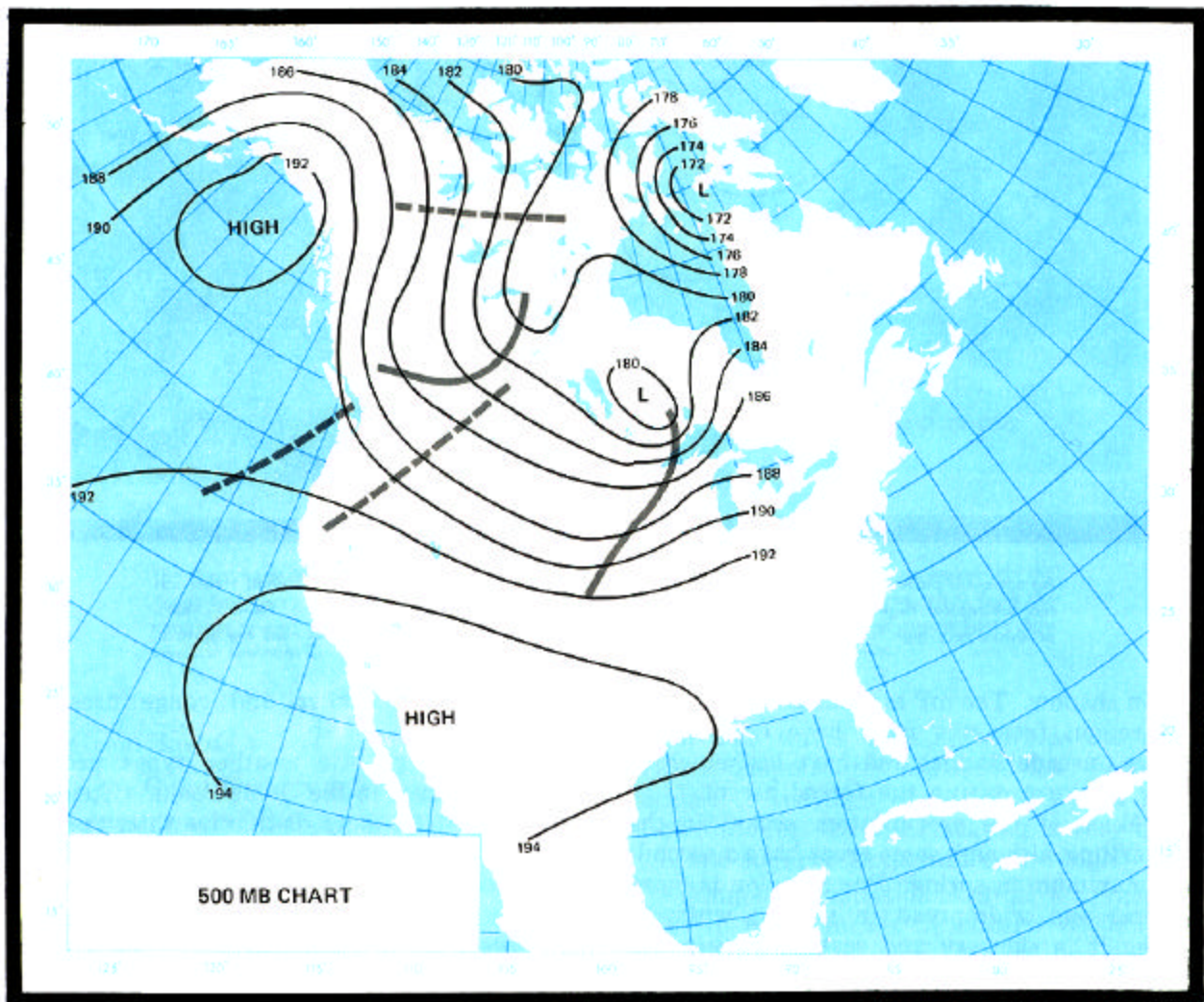

Short-wave troughs aloft, when accompanied by dry surface cold fronts, can cause high fire danger in the Great Basin and Rocky Mountain regions from late spring to early fall. This 500-mb. chart shows short-wave troughs moving eastward and southeastward in a northwesterly flow pattern. Past daily positions of the short-wave troughs are shown by heavy dashed lines.

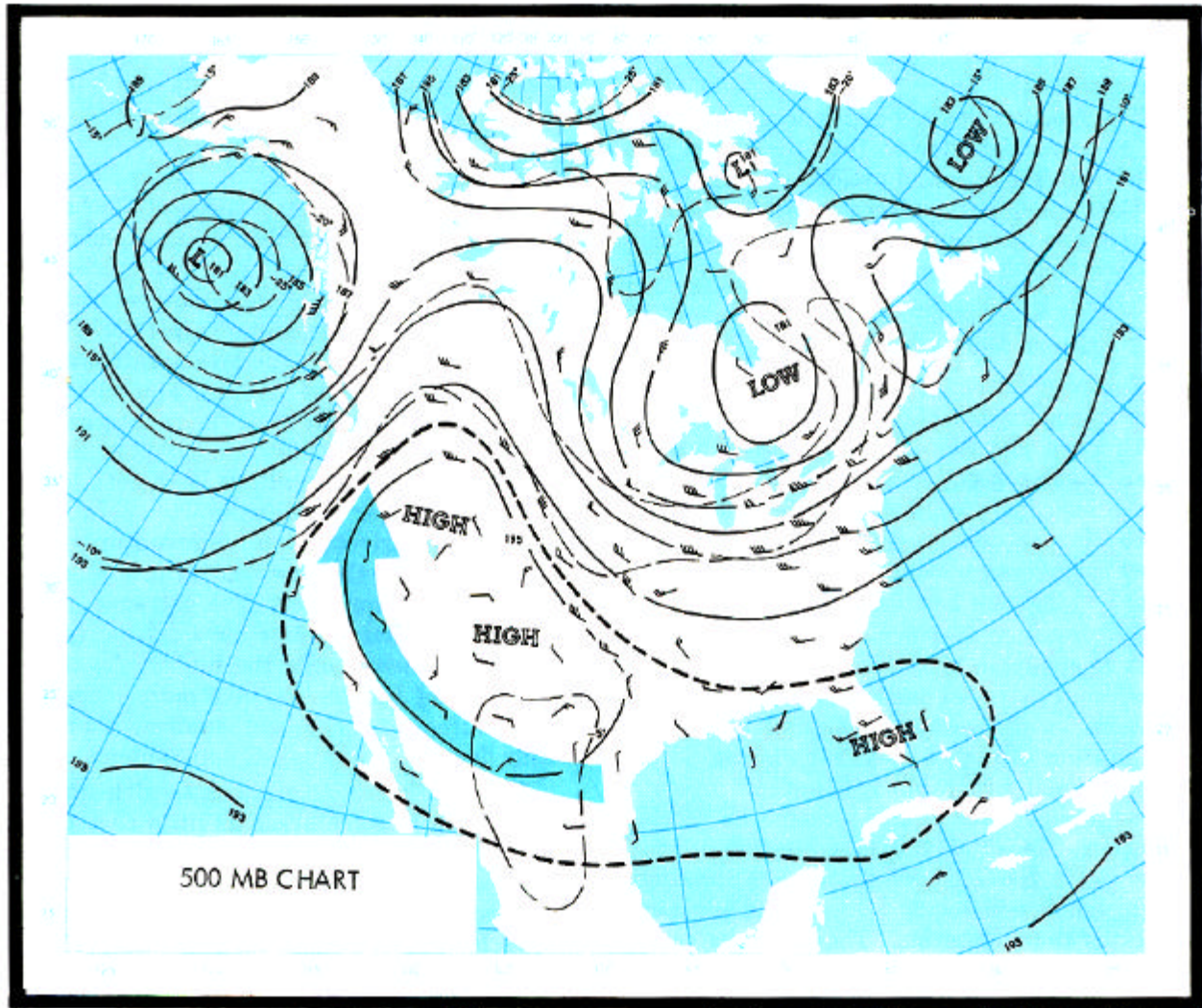

Moisture from the Gulf of Mexico is transported to the Southwest and the Western States at mid-tropospheric levels when a close High aloft moves into the position shown on this 500-mb. chart. Daytime heating and orographic lifting of the moist air combine to produce many high-level thunderstorms.

Cordilleran Highlands with numerous mountain ranges and dissecting river courses, in addition to the Rocky Mountains. Winter temperatures are quite low, and summer temperatures are moderate.

Annual precipitation ranges from 10 to 20 inches in the valleys to 40 to 60 inches locally in the mountains. Most of the precipitation falls in the winter and spring in the southern portion of this region, while in the northern portion it is fairly well distributed throughout the year, in most years. Winter precipitation is in the form of snow. In the southern portion, there often is widespread rainfall until June, followed by generally light precipitation

during the summer.

There is a gradual drying out of forest fuels during July and August with increasing fire danger. Frequent thunderstorms may occur then but little or no precipitation reaches the surface, so that frequent and severe lightning fires occur in both the Canadian and United States portions of the region. Also, extremely low humidities can result from large-scale subsidence of air from very high levels in the atmosphere. Occasional chinook winds on the east slope of the Rockies produce moderate temperatures and are effective in bringing subsiding air to the surface.

The fire season usually extends from June or July through September.

The synoptic weather types producing high fire danger are similar to those described for the Great Basin region. Particularly important are the ridge aloft pattern which produces warm, dry weather and the patterns producing high-level thunderstorms.

6. Southern Rocky Mountains

The vegetation in the Southern Rocky Mountain region consists of brush and scattered pine at lower elevations, and fir and spruce on higher ridges and plateaus. Many peaks extend above timberline. As in the Northern Rockies, winter temperatures are quite low, and summer temperatures are moderate for the latitude because of the elevation influence.

Precipitation is generally around 10 to 20 inches annually in the valleys and on eastern slopes, and 30 to 40 inches locally at higher elevations on the western slopes. The heavier precipitation at higher elevations is caused by the additional orographic lifting of mP air masses as they are forced across the Rocky Mountains. Most of the precipitation in the winter is in the form of snow. Precipitation is light but not infrequent during the summer, mostly as thunderstorms. These storms cause wildland fires, but ordinarily the burned acreage is small.

There are strong chinook winds with associated warm and dry conditions in the spring and fall on the eastern slopes of the mountains. These winds sometimes bring subsiding air from high levels in the atmosphere down to the surface and produce extremely low humidities.

The fire season normally extends from June or July through September, but earlier or later periods of critical fire weather may be caused by the chinook winds.

The synoptic patterns which produce high fire danger are the ridge aloft and dry cold-front passages. In addition, the pattern producing chinook winds is important on the eastern slopes. In this pattern, the airflow aloft is usually at right angles to the mountain range, while at the surface, a High is located in the Great Basin and a front is found east of the Rockies. In the area between the front and the Rockies the air flows downslope,

winds are strong, temperatures are high, and humidities are acutely low.

7. Southwest

The vegetation in the Southwest (including Sonora, Mexico) is mostly grass, sage, chaparral, and ponderosa pine. The region in which wildfire is a problem is essentially a plateau, but it also includes the southern portion of the Cordilleran Highlands. The low-elevation areas of the Southwest have a large annual range and a large diurnal range of temperatures, the latter being larger in the summer than in the winter. The higher elevations have both lower mean and lower maximum temperatures. Spring and early-summer temperatures are very high during the daytime because of clear skies and low humidities. The extreme southwest low-elevation portions have extremely hot and dry summers, while the higher elevations of the rest of the region have more moderate temperatures, and frequent summer thunderstorms during July, August, and September.

The Southwest is quite dry, with annual precipitation in some areas as little as 5 to 10 inches. This occurs as winter rain or snow, and as rains accompanying the frequent summer thunderstorms. In the first scattered storms in the late spring and early summer, little precipitation reaches the ground. Later in the summer, thunderstorms are usually wet.

The Southwest is characterized by an annual minimum of fire danger in the winter months and a secondary minimum in August. The most dangerous fire season is generally May and June when the problem of dry thunderstorms is combined with drought. Rainfall with thunderstorms accounts for the lower fire danger during the summer season. Fires started by lightning during this time of the year are usually not difficult to handle.

Since the Southwest has a generally high level of fire danger in spring and again in fall, the important synoptic patterns are those which cause peaks in fire danger or those which cause dry thunderstorms. The most critical fire weather occurs with a broadscale pattern aloft showing a ridge to the east and a trough to the west of the region, and southwesterly flow over the region. The fire danger peaks as

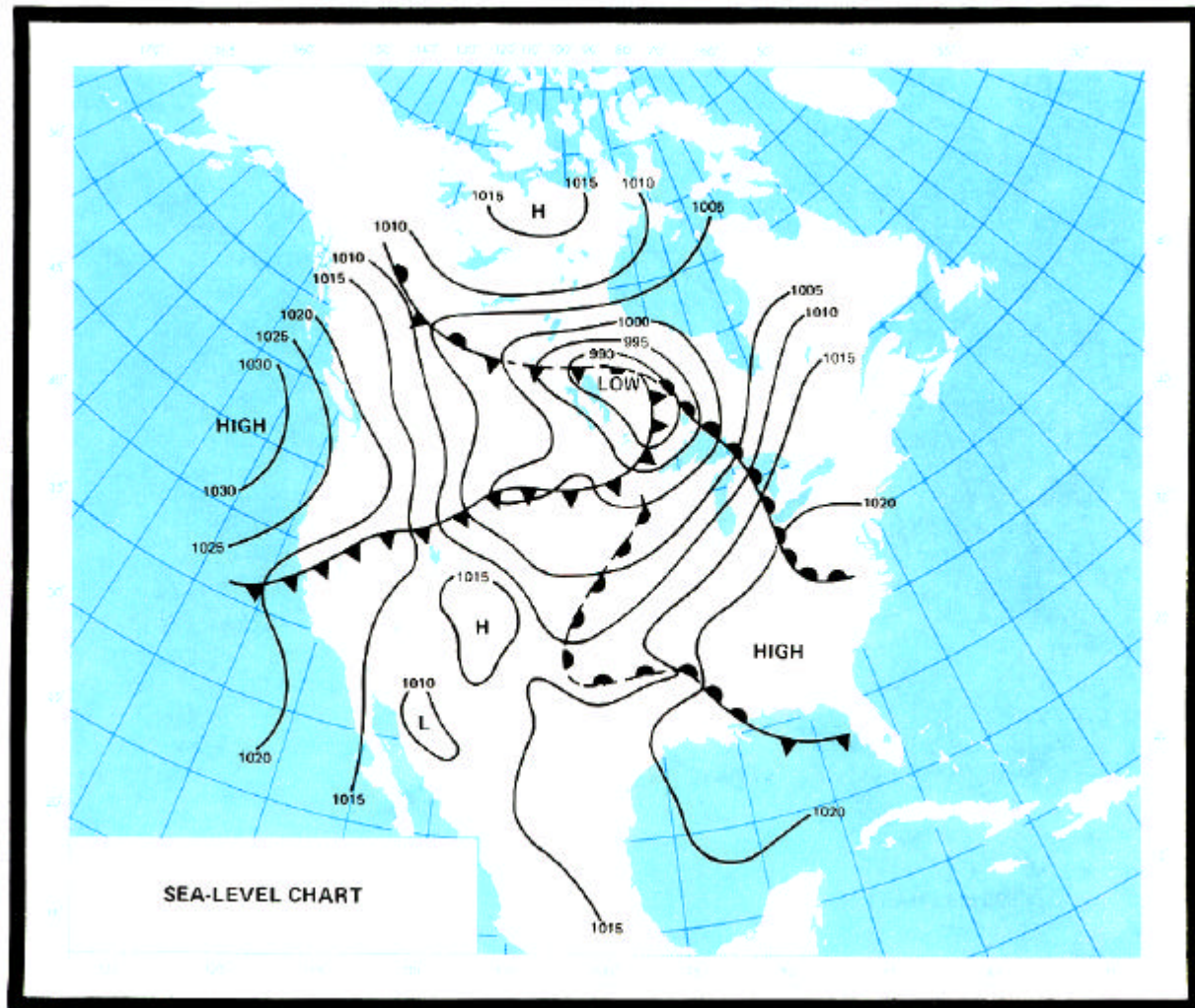

This winter sea-level chart illustrates the synoptic type producing chinook winds along the east slope of the Rockies. A High is located in the Great Basin and a front is in the Plains. In the area between the front and the Rockies, strong winds blow downslope, producing high temperatures and acutely low humidities. Airflow aloft is perpendicular to the mountain range. In this case, during 3 November days chinook winds progressed southward from Montana and Wyoming to Colorado, New Mexico, and Texas.

short-wave troughs move through this pattern and cause a temporary increase in wind speed. The pattern favorable for thunderstorms has the subtropical High aloft to the north of the region, and southeasterly flow bringing moist air from over the Gulf of Mexico to the Southwest region. When this pattern becomes established, the first moisture brought in is usually in a shallow layer aloft. The resulting thunderstorms tend to be of the dry, fire-starting type and appear when the fuels are dry and the fire potential is high. Then, as the pattern persists, moisture is brought from the Gulf of Mexico in a deep layer, and the thunderstorms

produce rain which reaches the ground and reduces the fire danger.

8. Great Plains

Vegetation in the Great Plains consists of grasses, cultivated lands, and timber in isolated regions. Fuels are generally too light and sparse to create a serious fire hazard except in the timbered areas. Temperatures in the Great Plains vary drastically from winter to summer—due to the frequent presence of cP air masses

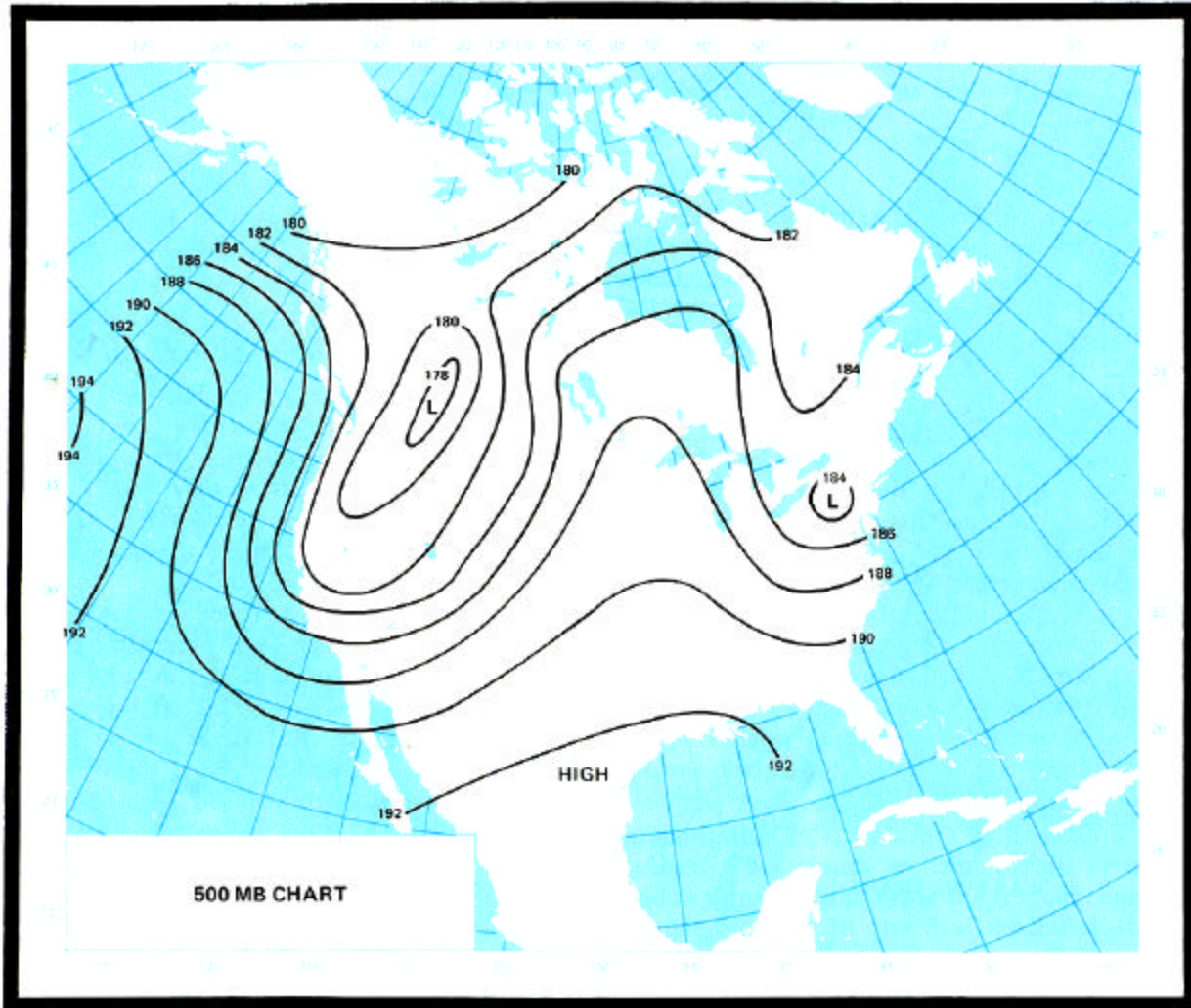

Southwesterly flow aloft often brings high fire danger to the Southwest, southern Great Basin, and southern Rocky Mountain regions. In this spring example, the ridge at 500 mb. is to the east and the trough to the west of the affected regions. Peaks in fire danger occur with the passage of short-wave troughs aloft and their associated dry surface cold fronts.

in the winter, and the occasional presence of cT and mT air masses in summer, particularly in the southern portions. The Plains are open to intrusions of winter cP air from Northern Canada, since no mountain barrier exists, and these air masses sometimes penetrate to the Southern Plains and even to the Gulf of Mexico. In the summer, cP air masses often influence the Northern Plains. At the same time, cT or mT air may persist in the Southern Plains and thus account for a wide latitudinal range in summer temperature. Maritime air from the Pacific must cross the western mountains to reach the Plains, and arrives as a relatively dry air mass.

Precipitation in the Great Plains is generally light to moderate, increasing both from north to south and from west to east. Amounts range from 10 to 20 inches in the northwest to 20 to 40 inches in the southeast. The western portion of the Plains is in the Rocky Mountain rain shadow. This, in part, accounts for the low precipitation. Also, mT air is less frequent in the western than eastern portions, and fronts are more intense in the eastern portion. Winter precipitation is usually in the form of snow in the north and, frequently, also in the south. Maximum precipitation occurs in the early summertime, mainly in the form of convective showers and frequent thunderstorms. Thunder-

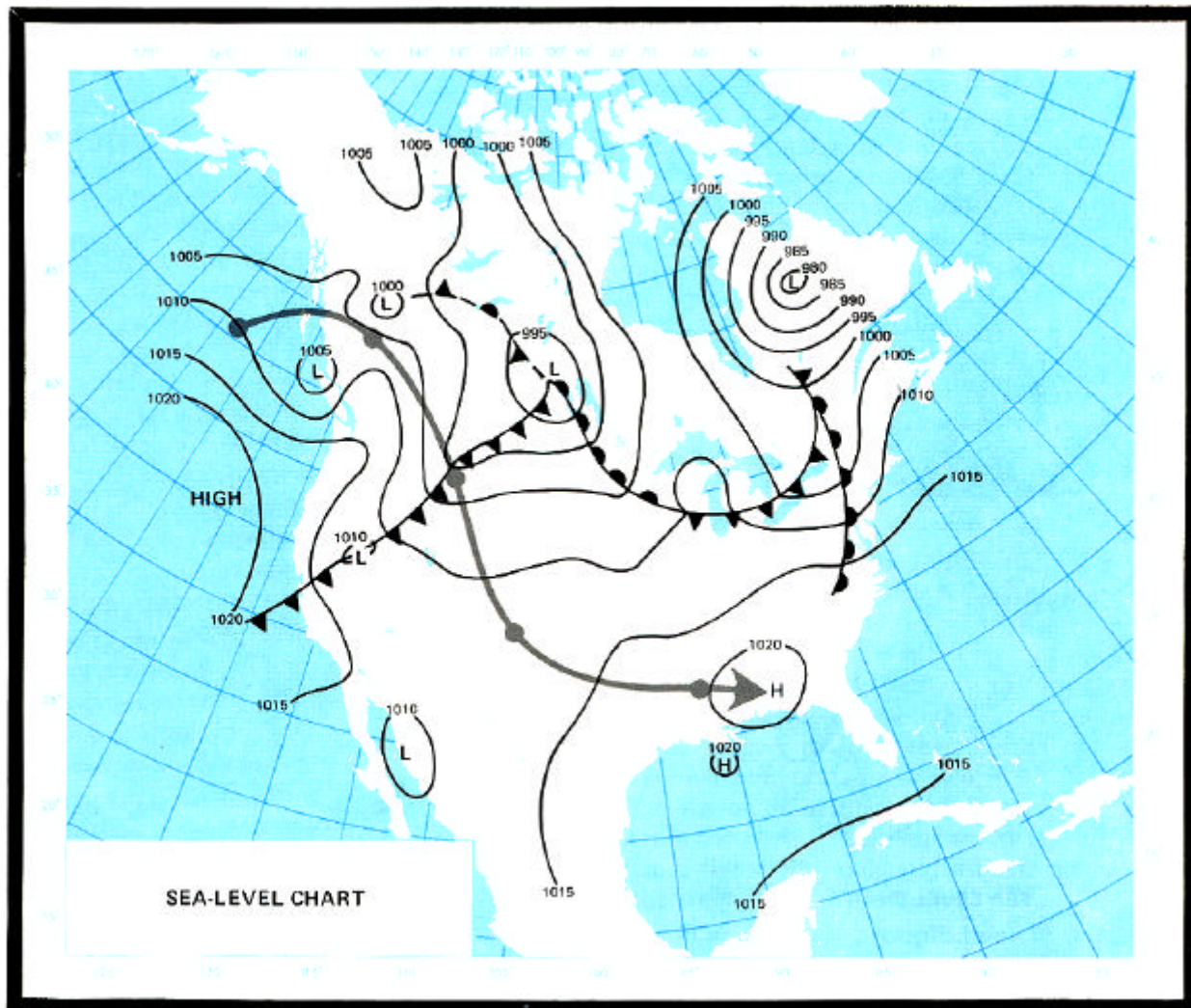

The Pacific High synoptic type is very common and can bring high fire danger to all regions east of the Rockies. An mP air mass enters the continent, usually in the Pacific Northwest or British Columbia, as a high-pressure area, loses much of its moisture as it moves across the mountains, and reaches the region east of the Rockies about as dry as cP air masses. The regions affected depend upon the track taken by the High. In this example, the flow aloft was meridional and the High plunged southward along the Rockies and then moved eastward. In other cases, the flow aloft may be zonal and the High will take a predominantly easterly course. Usually, the western or northwestern portion of the High is the most critical fire-danger area.

storms are usually wet and cause fewer fires than in the West.

The western portion of the Great Plains is subject to chinook winds which blow down the east slopes of the Rockies and extend some distance into the Plains. The combination of extremely low humidities and mild temperatures can create short periods of extreme fire danger in spring and fall, although chinook occurrence in the winter may be more frequent.

The fire season usually lasts from April through October, although the summer season, because of higher humidities, is less severe than spring or fall (except in the Black Hills).

Most critical fire-weather periods in this region are associated with the Pacific High synoptic type, the Bermuda High type, or the chinook type. Some periods occur with Highs from Hudson Bay or Northwest Canada, but these are more important to the regions farther

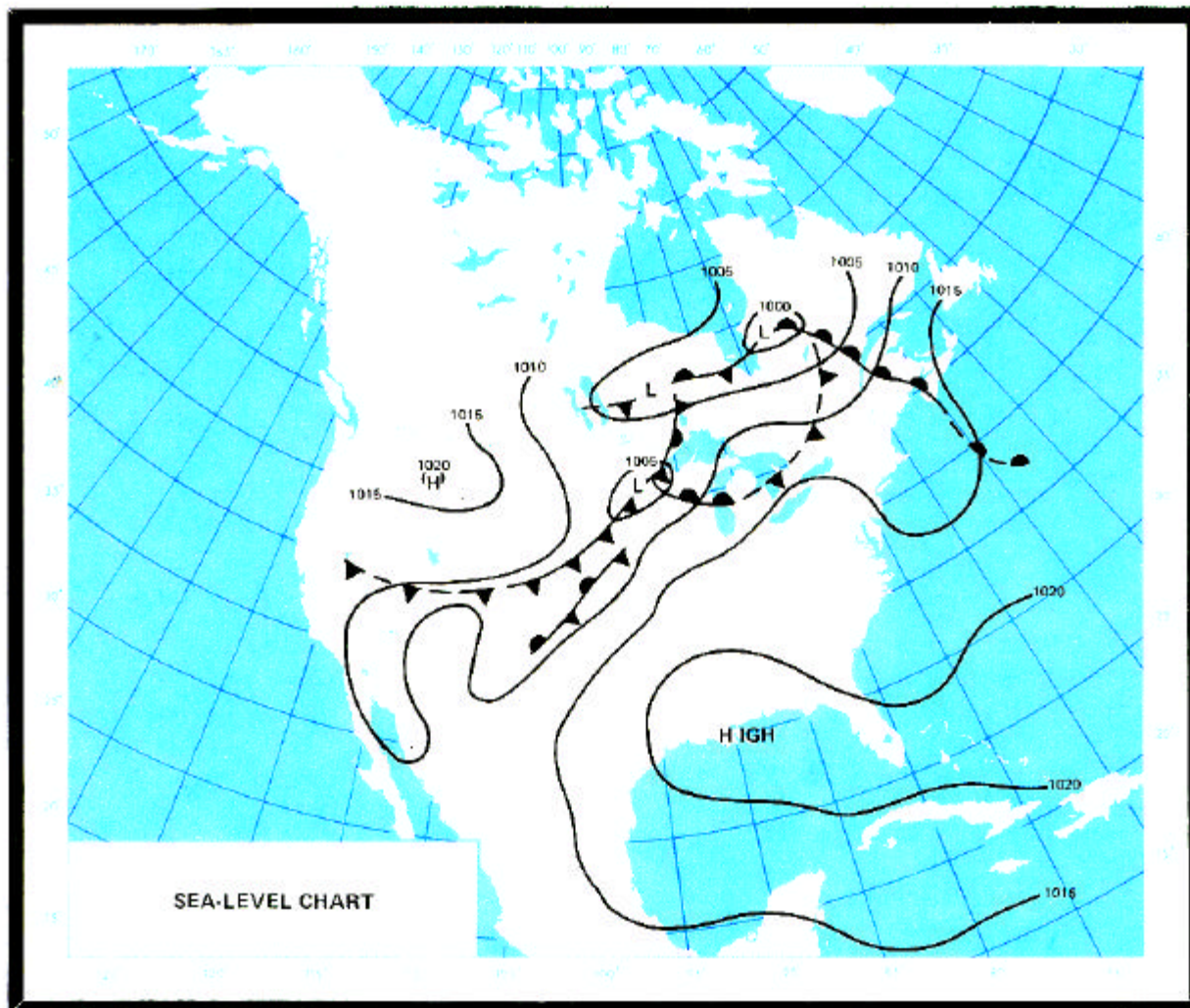

The Bermuda High type, shown on this sea-level chart, is most important in the Southern States but can produce high fire danger in any region east of the Rockies. It is most frequent in spring, summer, and early fall and may persist for long periods of time. A westward extension of the semipermanent Bermuda High, often well into Texas, cuts off Gulf moisture. This is the typical drought pattern for the eastern regions. Subsidence and clear skies produce low humidities and usually high temperatures.

east. The chinook type has been described above. The Pacific high type occurs when an mP air mass breaks off of the Pacific high-pressure cell and moves eastward across the mountains into the Great Plains following a Pacific cold front. The mP air loses much of its moisture in crossing the mountains, and arrives in the Plains as a comparatively dry and mild air mass. Highest fire danger is found on either the fore or rear sides of the High.

The Bermuda High type is most important in the southern portion of this region. In this type, the semipermanent Bermuda High extends far westward across the Gulf States and into Texas. A

ridge aloft is located over the middle of the continent. Warm, dry air from Mexico flows northward into the Plains, often causing a heat wave. The Bermuda High is a persistent summer pattern and sometimes causes long periods of drought. Nonforest types account for most of the area burned.

9. Central and Northwest Canada

With the exception of the southern prairies, vegetation in this part of Canada consists predominantly of spruce, pine, poplar, and aspen

forest with various mixtures of other species. In spite of the short growing season in the far northwest, comparatively good tree growth results from the long daylight hours. Much of the vegetation in the region reflects an extensive past fire history.

This region is glaciated with mostly low relief, except for the more broken topography of the mountain foothills along the western boundary. A common characteristic is very low winter temperatures. The region serves as both a source region and southward pathway for cold cP air masses. The large north-south and east-west geographical extent of the region results in significantly different summer temperature and moisture regimes from one part of the region to another.

The far northwest portion of the region has long, predominantly clear, sunny days contributing to rapid and extensive drying of forest fuels. Even though the summer season is short, drying is only occasionally and temporarily alleviated by summer showers. Proceeding southward and eastward, the summer days are not as long, although the season is longer. On clear days, maximum temperatures may be considerably higher here than in the northwest portion of the region, but cloudy days with shower activity are frequent.

Precipitation distribution is an important part of the regional climatology. The average annual amounts vary from 8 to 10 inches in the far northwest, to 20 inches in southern portions of the Prairie provinces, and up to 30 inches at the eastern extremity. Winter snows are generally light because the cold air holds little moisture, so it is usual for at least half of the total precipitation to come in the form of summer rains. These rains often are thunderstorms with accompanying lightning fires, and they occur with varying frequencies in virtually all parts of the region. The principal cyclone tracks during the summer run through the central part of the region.

The geographic extent of this region is so great that it is not practical to designate any particular fire season for the area as a whole. For example, locally there may be both a spring and fall fire season, a summer fire season, or any combination of these.

10. Sub-Arctic and Tundra

This region, extending from the Mackenzie Delta to the Atlantic, supports scattered patches of scrub spruce forest in the south merging with open tundra in the north. It is all low glaciated terrain. Annual precipitation is about 10 to 15 inches in the northwest and up to 20 to 25 inches in the east. More precipitation falls in the summer than in winter.

The fire season is principally during mid-summer. Strong winds and low humidities are common. The average number of fires is small, with apparently half or more caused by lightning. There is considerable evidence of severe past fire history.

11. Great Lakes

The vegetation in the Great Lakes region consists mainly of aspen, fir, and spruce in the north and some additional hardwoods in the south. There are several upland areas, including the western slopes of the Appalachians, but most of the region has been heavily glaciated. Winter temperatures are quite cold, and summer temperatures are variable. In summer, the region is subjected to cool cP air masses from the north, warm and moist mT air masses from the south, and mild mP air masses from the west.

The annual precipitation in the Great Lakes region is moderate, generally over 30 inches. It is fairly well distributed throughout the year, but most areas have somewhat larger amounts in summer. Winter precipitation is mostly in the form of snow, and the greatest amounts occur with intense cyclones involving mT air masses. Summer precipitation is largely in the form of showers and thunderstorms. Lightning fires are common on both sides of the St. Lawrence and in the northern Great Lakes area.

Strong winds are common with intense storms in fall, winter, and spring, and with squall lines and strong cold fronts in the summer. Humidities are normally moderate to high except during brief periods when cP and mP air masses are warmed by heating and subsidence before much moisture can be added to them.

The Great Lakes are sufficiently large to influence the climate of portions of the region.

Near the shores, when the gradient winds are weak, lake breezes can be expected on summer days. The lake breeze is cool and humid and moderates the summer climate along the lake shores.

On a larger scale, the Great Lakes modify air masses that pass over them. Cold air masses passing over the warmer lakes in the fall and winter are warmed and pick up considerable moisture, resulting in heavier precipitation to the lee of the lakes. The amount of moisture picked up depends to a large extent upon the length of the overwater fetch. In spring and summer, warm air masses are cooled as they pass over the cooler waters of the lakes. If the air mass is moist, fog and low clouds form and drift over the leeward shores.

The Great Lakes also affect the synoptic-scale pressure pattern. In spring and early summer when the lakes are relatively cool, they tend to intensify high-pressure areas that pass over them. In fall and winter when the lakes are relatively warm, they tend to deepen Lows that pass over them. On occasion, they will cause a trough of low pressure to hang back as the Low center moves on toward the east. This tends to prolong the cloudiness and precipitation.

The fire season generally lasts from April through October with peaks in the spring and fall. In hardwood areas, the leafless trees in spring expose the surface litter to considerable drying, which increases fire danger. After the lesser vegetation becomes green and hardwoods leaf out, the fire danger decreases. In fall, the lesser vegetation is killed by frost, the hardwoods drop their leaves, and the fire danger again increases.

The synoptic weather patterns producing high fire danger in the Great Lakes region are usually those involving Highs moving into the region from Hudson Bay, Northwest Canada, or the Pacific. Occasionally the region is affected by a Bermuda High type, but this is infrequent and usually occurs during the period when the vegetation is green. The Pacific High type, which was discussed with the Great Plains region, causes more high fire-danger days than any other type.

The Hudson Bay High and Northwest Canadian High types involve cP air masses that move southward or southeastward from their source regions in Canada and on through the Great Lakes region under the influence of a meridional

pattern aloft. These air masses are warmed by surface heating and subsidence as they move to lower latitudes. High fire danger is occasionally found in the forward portion of the air mass, if the front preceding it is dry. But the most critical area is usually the western or northwestern portion of the High. By the time this portion of the High reaches a locality, the air mass has been warmed by heating and subsidence, and the humidity becomes low and remains low until either Gulf moisture is brought into the system or the next cold front passes.

12. Central States

The vegetation in the Central States region is mostly hardwoods, and mixed pine and hardwoods, interspersed with agricultural lands. The topography is mostly flat to gently sloping. The principal exceptions are the Missouri and Arkansas Ozarks and the western portions of the Appalachians. Summer temperatures tend to be high in the southern portion of the region, but relative humidities are usually high also. The northern portion experiences brief periods of high temperatures and brief periods of moderate temperatures as mT air masses alternate with either mP or cP air masses. Winters can be extremely cold in the north.

Annual precipitation is moderate, generally 20 to 45 inches, with snow and rain in the winter, and showers and thunderstorms in the summer. Usually, there is sufficient rain with thunderstorm activity to minimize lightning fire occurrence. The maximum precipitation usually falls in early summer in the north, but there is a fair distribution throughout the year in the southern portion. There are occasional dry summers, but the green tree canopies and green lesser vegetation are usually sufficiently effective in the summer to keep fires from being aggressive.

As in the Great Lakes region, the principal fire season is in spring and fall when the hardwoods are not in leaf and the lesser vegetation is dead. In the southern portion of the region the spring season is somewhat earlier and the fall season somewhat later than in the northern portion.

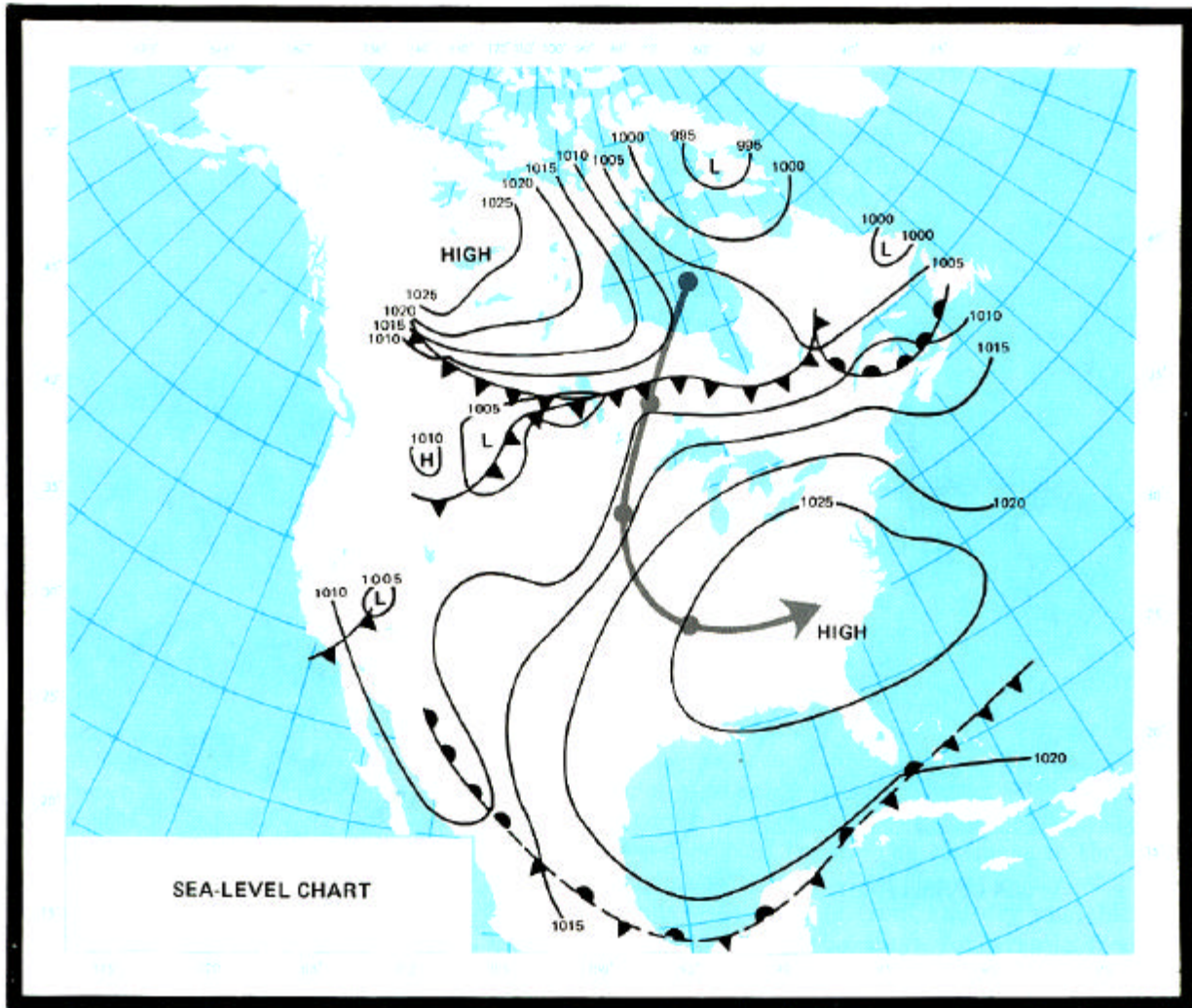

The Hudson Bay High type can bring high fire danger to any of the regions east of the Rockies. As shown on this sea-level chart, a cP air mass from the vicinity of Hudson Bay moves southward or southeastward, warming and subsiding as it moves to lower latitudes. The highest fire danger is usually found on the northwest side of the High. This type is most frequent in spring and fall, with spring being the most critical season.

The synoptic weather patterns producing high fire danger in the Central States are similar to those affecting the Great Lakes region, except that the Bermuda High type influences the southern portion of the Central States region more frequently. Nevertheless, the Bermuda High is the least important of the types, both from the standpoint of frequency and from the fact that it occurs mainly during the summer months when vegetation is green. The Pacific High, Hudson Bay High, and Northwestern Canadian High types, in that order, cause nearly all of the high fire danger in spring and fall. These types have been described above for

adjoining fire climate regions.

13. North Atlantic

The forests in the North Atlantic region vary from extensive spruce stands in the north to predominantly hardwoods in the southern portions. The region is bounded on the west by the crest of the Appalachians and on the east by the sea. The coastal plain is wider than that facing the Pacific and increases in width

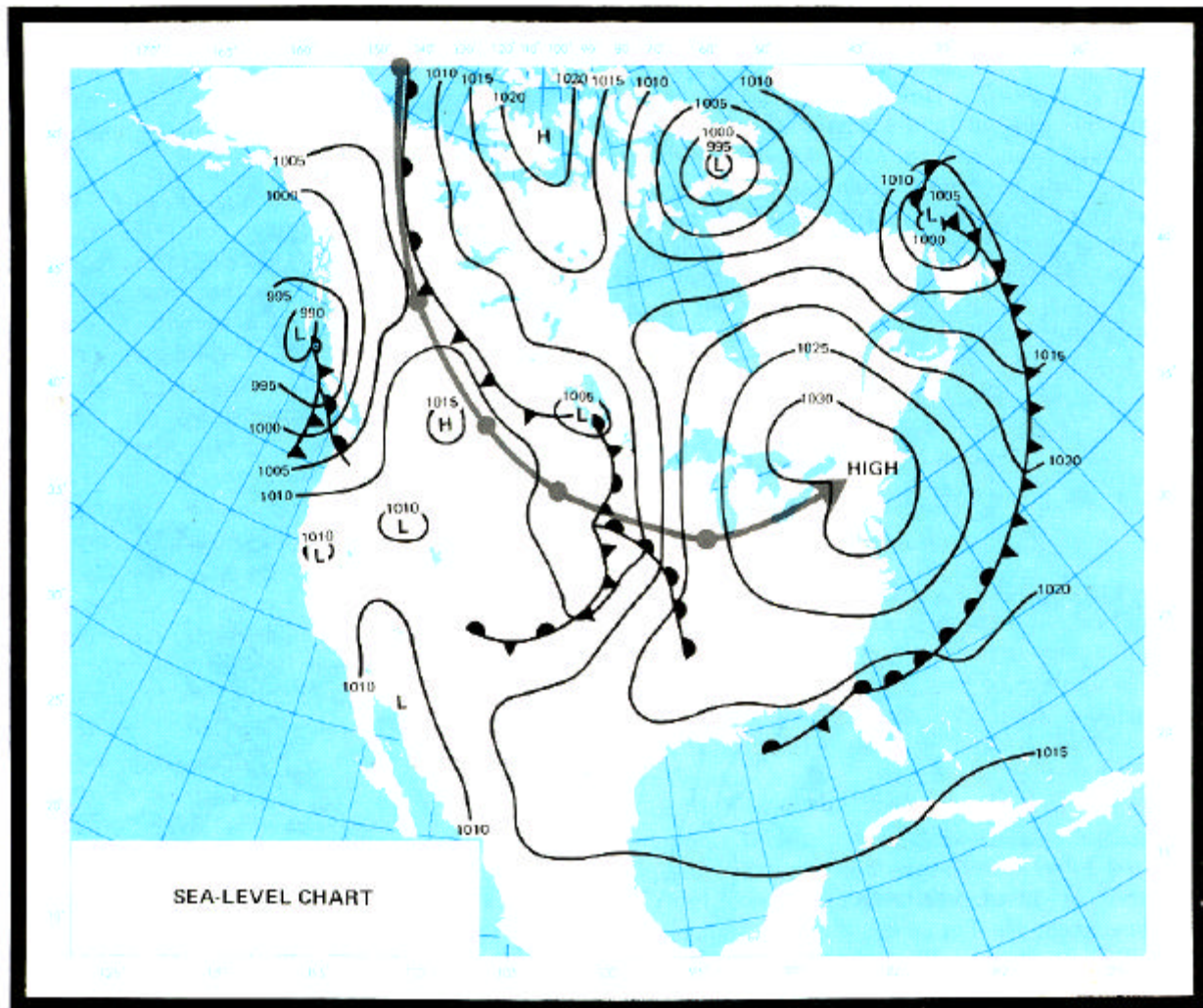

The Northwest Canadian High synoptic type is least frequent in summer and most frequent in winter. In winter the air mass is so cold, however, that fire danger is low. The highest fire danger is produced in spring and fall. As shown on this sea-level chart, a dry cP air mass from Northwest Canada moves southeastward under meridional flow aloft, and warms by subsidence and passage over warmer land as it moves to lower latitudes. It can affect all regions east of the Rockies. The north and northwest sides are most critical, but high fire danger can occur on any side of the High.

from north to south. The immediate coast is influenced by the Atlantic Ocean and often is cool and foggy. But because the general movement of weather systems is from west to east, the maritime influence usually does not extend far inland. For this reason, temperatures can be quite low in winter and quite high in summer. On occasion, mP air from the Atlantic moves sufficiently southwestward to influence this region.

The annual precipitation is moderate to heavy, with totals of 40 to 50 inches, and is

fairly well distributed throughout the year. There is a slight maximum during the summer and a slight minimum during the spring. Storms moving into the region from the west do not produce as much precipitation on the east side of the mountains as storms which move northeastward along the coast. In the first case, the descending flow on the east side of the mountains diminishes the precipitation. In the second case, the cyclonic circulation around a Low moving along the coast brings in moist air from over the ocean, and the mountains

provide additional lift to increase the precipitation. Wet thunderstorms are common, and lightning fires are few.

Heavy snows in the northern coniferous forests persist well into spring. The leafless hardwoods in the areas of lesser snow cover expose the surface litter to drying influences of the sun and strong winds during the spring months. Both the conifers and hardwoods are susceptible to cumulative drying during the fall.

The fire season usually lasts from April through October with peaks in the spring and fall. Drought years are infrequent but may be severe.

The synoptic weather types associated with high fire danger in this region are the Pacific High, Hudson Bay High, Northwest Canadian High, and Bermuda High. All of these types have been described above.

14. Southern States

The vegetation in the Southern States consists mainly of pines along the coastal plains, hardwoods in bays and bottomlands along stream courses, and mixed conifers and hardwoods in the uplands. **Flash fuels, flammable even very shortly after rain, predominate in this region.** The topography along the Gulf and Atlantic is low and flat. Inland from the Atlantic Coast it merges with an intermediate Piedmont area. The southern Appalachians are included in this region, and the central portion includes the lower Mississippi Valley.

Summers are warm and generally humid, because the region is almost continuously under the influence of an mT air mass. Winters have fluctuating temperatures. When mT air moves over the region, high temperatures prevail. Following the passage of a cold front, cP air may bring very cold temperatures—well below freezing—throughout the Southern States.

Annual precipitation varies from 40 to 60 inches over most of the region, except for about 70 inches in the southern Appalachians and over 60 inches in the Mississippi Delta area, and falls mostly as rain. The influence of the moist mT air from the Gulf of Mexico causes abundant rainfall in all seasons, with slightly higher amounts in August and September due to the presence of

hurricanes in some years. Spring and fall have less precipitation than summer or winter, with spring being wetter than fall. Winter precipitation is usually associated with frontal lifting or with Lows that develop over the Southern States or the Gulf of Mexico and move through the region. Summertime precipitation is mostly in the form of showers and thunderstorms. During the colder months, much fog and low stratus are formed by the cooling of mT air as it moves northward.

The fire season in the Southern States is mainly spring and fall, although fires may occur during any month.

The four synoptic types that bring high fire danger to the other regions east of the Rockies also bring high fire danger to the Southern States. The Hudson Bay High and Northwest Canadian High types affect this region less often than the regions to the north. The airflow pattern aloft must have considerable amplitude for Highs from Canada to reach the Southern States.

The Pacific High type causes more days of high fire danger than any other type. Pacific Highs may reach this region with either meridional or zonal flow aloft. **Very often, the most critical fire weather occurs with the passage of a dry cold front.** The air mass to the rear may be mP or cP. The strong, gusty, shifting winds with the cold front and dry unstable air to the rear set the stage for erratic fire behavior.

The Bermuda High type is second to the Pacific High in causing high fire danger in this region. This type is rather stagnant and persists over the region for long periods of time, mostly in spring, summer, and fall. The **cutting off of Gulf moisture** by the Bermuda High, when it extends westward across the Southern States to Texas, is **the typical drought pattern** for this region. Aloft, a long-wave ridge is located over the central part of the continent and the belt of westerlies is far to the north, near the Canadian border.

Subsidence and clear skies produce low **humidities and high temperatures.** These factors, plus the extended drought, **set the stage for high fire danger.** Peaks in fire danger occur as winds increase with short-wave trough passages and their associated surface cold fronts on the north side of the Bermuda High. Lightning accounts for only a minor number of fires.

15. Mexican Central Plateau

The vegetation in the plateau region of Mexico is largely brush and grass with ponderosa pine at higher elevations. The region is a high plateau and mountainous area, generally above 6,000 feet, lying between the two principal north-south mountain ranges. It differs from the Southwest mainly in that it is affected more directly by moist air from both the Gulf of Mexico and the Pacific, although this influence is restricted, by mountain

barriers. Temperatures are comparatively cool for the latitude because of the elevation. Characteristically, the summers are warm with frequent convective showers and generally high humidities. The winters are cool and dry.

The annual precipitation is low to moderate. The maximum occurs in the summer with frequent thunderstorms due to continental heating. In spite of greater precipitation, the fire season is mostly in the summer.

SUMMARY

From this brief look at the fire climate over the North American Continent, we have seen that variations in climate, along with variations in vegetative conditions, produce differences in the fire seasons from one region to the next.

In general, the fire season in the western and northern regions of the continent occurs in the summertime. But the fire season becomes longer as one goes from north to south, becoming nearly a

year-round season in the Southwest and southern California.

In the East, the fire season peaks in the spring and fall. Some fires occur during the summer months, and in the Southern States they can occur in winter also.

In Mexico, the low-lying coastal areas are tropical and have little fire danger, while the high-level central plateau has a summer fire season.

INDEX

A

Absolute humidity, 87
variations in, 41—42
Absorption of radiation, 9, 10, 23, 26
Absorptivity, 23
Adiabatic chart, 51, 169—171
Adiabatic process, 17, 50, 51
compression in, 17, 51
expansion in, 17, 50
humidity changes in, 43
at saturation, 18, 50, 53—55
layer stability and, 55—56, 171
Adiabatic rate of temperature change, 17, 18
lapse rate related to, 17, 18
at saturation, 18, 50, 53—55
Adsorption of water vapor, 185, 186
Advection, 58
stability affected by, 53, 169
Advection fog, 161
Air, composition, 3
Air drainage, 115, 117
Air masses, 25, 128—136
characteristics, 135
classification, 129—130
continental, 129
defined, 128
and fire weather, 127
formation, 129
fronts separating, 129, 137
maritime, 129
modification, 25, 130, 136
paths of movement, 129
polar, 129
source regions, 129
temperatures in, 25
thunderstorms in, 177
tropical, 129
weather and, 131—135
in summer, 182—135
variations in, 135
in winter, 131—132, 135
Aleutian Low, 80, 81, 82
Alto cumulus clouds, 157
Altostratus clouds, 157—158
Anemometer, 87
exposure, 87
Anticyclones, 75, (see Highs)
Appalachian Mountains, 198, 199
Atlantic and Gulf breezes, 111—112
Atlantic Ocean, 199
Atmosphere, 2

composition of, 3
layers of, 2
Atmospheric moisture, (Chap. 3) 33—48
and fire behavior, 33
and fuel moisture, 33, 185—188
sources of, 40—41
Atmospheric pressure, 3
Atmospheric soundings, 87
Azores-Bermuda High, 80, 81, 82

B

Balance of forces, 75—78
Balloons, 87
Barometers, 72—73
aneroid, 72—73
mercurial, 3, 72
reduction to sea level, 73
Basic theory of general circulation, 69—72
Bermuda High, 82
weather type, 213—214, 219
Bishop wave, 82
Black body, 10
Bora, 100
Bound water, 185
Breezes, land and sea, 16, 109—113
British thermal unit, defined, 6
Buoyancy, 9, 52
and stability, 52, 53

C

California Current, 199
California Heat Low, 81
Carbon dioxide, in atmosphere, 3
in radiation, 12
solid, for cloud seeding, 153—154
Celsius (Centigrade) temperature scale, 20, 21
Centrifugal force, 75, 76
Changes of state, 7
Chinook, 62, 102
weather type, 210, 211
Circulation, general, 16, (Chap. 5) 68-84, 199-200
cellular, 71—72
patterns 78—83
summer, 80—82
winter, 80, 82—83
primary, 69—72
secondary (See Circulation patterns)
Circumpolar westerlies, 78—80

Cirrocumulus clouds, 155—156
 Cirrostratus clouds, 155—156
 Cirrus clouds, 155
 Classification of air masses, 129—130
 Classification of thunderstorms, 177
 Climate, (Chap. 12) 196—220
 Cloud electricity, 175—177
 Clouds, 144—163

- absorption of radiation by, 12—14, 22, 23
- altocumulus, 157
- altostratus, 157—158
- cirrocumulus, 155—156
- cirrostratus, 155—156
- cirrus, 155
- classification, 154
- composition, by type, 155—163
- condensation in, 151—152
- cumulonimbus, 161—163
- cumulus, 161—163
- effect on radiation, 11—14, 22, 23, 26
- entrainment in, 171
- formation of, 151—152
- frontal types, 138, 139—140, 150
- heights, 147, 155, 157, 159, 161—162
- high 154—157
- low, 154, 159—161
- middle, 154, 157—158
- nimbostratus, 158, 159
- radiation from, 13—14
- recognition, 154—163
- reflection from, 12—14, 22, 23
- seeding, 153—154
- stratocumulus, 159, 160
- stratus, 159—160
- types, 100, 154—163
- wave, 100

 Clouds with vertical development, 161—163
 Coalescence, 154
 Coasts, temperature effects, 32, 199
 Cold fronts, 94, 95, 138—139
 Colorado Low, 83
 Combined heat and orographic lift, 57
 Composition of the atmosphere, 3
 Compression, in adiabatic process, 17, 51

- and temperature increase, 6, 7
- in vertical motion, 17, 51, 56
- and work, 7

 Condensation, 8, 35—36

- in clouds, 151—152
- heat of, 8, 25, 36

 Condensation level, 54
 Condensation nuclei, 151—152
 Condensation trails (Contrails), 146
 Conditional instability, 54—55

- and thunderstorms, 167, 169—171

 Conduction, 8, 9, 23—24
 Conductivity, 8, 23

- thermal, 8, 9, 23

 Constant-level charts, 72—73
 Constant-pressure charts, 73—74

contours on, 74
 winds on, 78
 Continental air masses, 129
 Continental polar air masses, 131, 132—133
 Continental tropical air masses, 135
 Contours, 73, 74
 Contrails, 146
 Convection, 8, 9, 56, 108

- cells, 16, 69—72
- (See also Thunderstorms, cells)
- free, level of, defined, 54
- turbulence, related to, 89

 Convective currents, 9, 64
 Convective winds, 86, 106, (Chap. 7) 107—126
 Convergence, defined, 57

- and layer stability, 57
- lifting by, 150—151

 Cooling, by evaporation, 85, 153
 Coriolis force, 70, 75

- and general circulation, 70, 72
- in geostrophic balance, 75—76
- in rotating plane, 70
- variation of, 75

 Cumulonimbus clouds, 161—163
 Cumulus clouds, 161—163
 Cyclones, 74 (see Lows)

D

Daily range of temperature, 31—32
 Day length, 15
 Dead fuel moisture, 185—194

- effects of, canopy, 191
- clouds, 191
- topography, 191
- winds, 191—192
- estimating, 192—194

 Deflection force (see Coriolis force)
 Density, of air related to temperature, 6

- defined, 6

 Dew, 165
 Dew-point lapse rate, 43, 54, 146
 Dew-point temperature, defined, 36

- tables of, 37, 38, 39

 Diurnal temperature variations, 31—32
 Divergence, defined, 57

- and layer stability, 57

 Doldrums, 72
 Downdraft in thunderstorms, 16, 124—125, 173—175
 Downslope afternoon winds, 121—122
 Drizzle, defined, 163
 Drops, coalescence of, 154

- evaporation of, 153
- sizes in clouds, 152—153

 Dry-adiabatic lapse rate, 17, 18, 50
 Dry cold fronts, 139, 219
 Dust devils, 65, 122—123, 163

E

Earth, heat balance of, 11—16

- orbit, 14

- radiation, 11—16
- revolution, 14, 15
- rotation, 14, 70
- and sun, 14, 15
- Earth's atmosphere, 3
- Easterly waves, 83
- East winds, 102
- Eddies, in mountain topography, 97—99, 100
 - and turbulence, 88—91
 - in winds at surface, 88—91, 105
- Electricity of thunderstorms, 175—177
- Emission of radiation, 9, 10, 23
 - from snow surface, 23
- Emissivity, defined, 10
- Energy, defined, 4
 - forms of, 4, 5
 - internal, 7
 - kinetic, 4, 5
 - potential, 4, 5
 - temperature and, 4
 - transformation of, 4, 5
- Entrainment, 17, 171
- Equator, 15, 69, 71, 72
 - tropopause near, 2
- Equilibrium moisture content, 187—188
- Equinox, 15
- Evaporation, 8, 35—36, 41
 - air masses affected by, 136
 - cooling by, 25, 35
 - in downdraft, 173
 - of drops, 153
 - from land, 41
 - from oceans, 41
 - of rain, 146
 - wind effect on, 41
- Expansion, in adiabatic process, 17, 50
 - in saturated case, 53—54
 - and temperature reduction, 6, 7
 - in vertical motion, 17
- Eye of hurricane, 83

F

- Factors necessary for thunderstorm formation, 167—169
- Fahrenheit temperature scale, 20, 21
- Fall wind, 100
- Fiber saturation, 185—186
- First gusts in thunderstorms, 125, 173
- Fire behavior, and atmospheric moisture, 33
 - and fuel moisture, 180, 191
 - and stability, 49
 - and temperature, 19
 - and thunderstorms, 172
 - and wind, 85, 107
- Fire climate, defined, 197
 - regions, (Chap. 12) 196—220
 - Central and Northwest Canada, 214—215
 - Central States, 216—217
 - Great Basin, 206—208
 - Great Lakes, 215—216
 - Great Plains, 211—214
 - Interior Alaska and the Yukon, 202—204
 - Mexican Central Plateau, 220
 - North Atlantic, 217—219
 - Northern Rocky Mountains, 208—210
 - North Pacific Coast, 204
 - Southern Rocky Mountains, 210
 - Southern States, 219
 - South Pacific Coast, 204—205
 - Southwest, 210—211
 - Sub-Arctic and Tundra, 215
- Fire danger, associated with weather types, 204-214
 - 215—219
 - rating, 197
- Fires, lightning, 4, 166, 168, 208, 209
- Fire seasons, by regions, 202—220
- Fire weather, iv
 - and air masses, 127
 - and clouds, 144
 - and fog, 159
 - and fronts, 127, 137, 139, 140
 - and general circulation, 68
 - and precipitation, 144
 - and thunderstorms, 166
- Firewhirls, 123—124
- Fuel moisture, (Chap. 11) 180—195
 - and fog, 159
 - and precipitation, 144, 166
 - related to atmospheric moisture, 33
- Foehn wind, 62—63, 100—104
- Fog, advection-radiation, 161
 - classification, 161
 - defined, 159
 - ground, 28
 - high, 159
 - stratus and, 159—161
 - upslope, 151, 161
- Forces, balance of, 75—78
- Free water, 186
- Freezing rain and drizzle, 163
- Friction, effect on fronts, 138
 - effect on wind, 75, 77—78, 88, 91—92
 - effect on sea breeze, 112
 - and gradient wind level, 88
 - layer, 78, 88, 92
- Frontal thunderstorms, 138, 139, 140, 141, 142, 177
- Frontal waves and occlusions 141—143
- Frontal winds, 93—96, 138
- Frontal lifting, 56, 150
- Fronts, air masses and, (Chap. 8) 127—143
 - clouds and, 138, 139—140, 150
 - cold, 94, 95, 138—139
 - defined, 94, 138
 - dry, 139
 - slope of, 138
 - cyclones and, 142
 - defined, 94, 129
 - and fire weather, 127, 137, 139, 140
 - occluded, 94, 141—143
 - polar (See Polar front zone)

- precipitation and, 138, 139, 140, 141, 142
- stationary, 141
- slope, 137
- upper cold, 142, 143
- veering of wind at, 94—96
- warm, 94, 95, 139—141
 - defined, 94, 139
 - slope, 139
- waves on, 141

Frost, 165

Funnel cloud, 179

Fuel, aerial and ground, 189—191

- defined, 181
- drying processes, 186—191
- moisture, 3, (Chap. 11) 180—195
 - indicator sticks, 192—193
- wetting processes, 185—186

G

- Gases, in the atmosphere, 3
- General circulation, 16, (Chap. 5) 68—84
 - and fire weather, 68
 - heat transfer by, 69—72
 - jet stream in, 79—80
- General wind, (Chap. 7) 85—106
 - defined, 86
- Geographical features of North America, 198—200
- Geostrophic balance, 75—76
- Geostrophic flow, 75—76
- Geostrophic wind (see Wind)
- Gradient flow (or wind), 76—78
- Gradient, pressure, 75
 - temperature, 8
- Gravity, 3
 - buoyancy related to, 52
- Great Basin, 206—208
 - High, 83
 - and foehn winds, 101
 - weather type, 205—206
- Great Lakes, 215—216
 - influence on climate, 199, 215—216
- Great Plains, 211—214
- Greenhouse effect, 12
- Ground fog, 28
- Gulf and Atlantic breezes, 111—112
- Gulf Stream, 199
- Gusts, in thunderstorms, 173
 - in winds at surface, 27, 88, 89, 91, 113, 125

H

- Hail, 163, 165
- Halo, 155, 156
- Haze, 22, 65, Heat, capacity, 6, 24
 - of condensation, 8, 25
 - released in ascent, 18, 53
 - of fusion, 7
 - internal energy related to, 7

- of sublimation, 8
 - specific, 6
 - of vaporization, 7, 8, 18
- Heat balance, 11—16
- Heat energy, 4
 - and temperature, 4, 6, 7, Heat Low, 81
- Heat sources of lift, 56, 69, 146—148
- Heat transfer, 8—11
 - by general circulation, 16, 69—72
- Heat transport by Highs and Lows, 79
- Heights of clouds, 147, 155, 157, 159, 161—162
- Heights on constant-pressure charts, 73—74
- High clouds, 154—157
- High-pressure systems, 3, 16, 17, 57, 75
- Highs, 75
 - balance of forces in, 77
 - defined, 75
 - gradient wind in, 77
 - semipermanent, 80—83
 - tracks of, 81—83
- Horse latitudes, 72
- Hudson Bay High weather type, 216—217
- Humidity, 37—48
 - absolute, 37
 - variations in, 41—42
 - measurement, 38—40
 - relative, 37—38
 - defined, 37
 - effects of air masses, 48
 - effects of topography, 45—46
 - effects of wind, 46
 - effects of vegetation, 46—48
 - related to temperature, 37—38, 43—44
 - tables, 38—40
 - variations in, 48—45
- Hurricanes, 72, 83
- Hydrograph, 40
- Hygroscopic particles, 152
- Hygrothermograph, 40

I

- Ice, melting point of, 7
 - vapor pressure over, 153
- Ice crystals, formation, 152
 - growth, 152—153
- Ice-crystal process, 153
- Icelandic Low, 80, 81, 82
- Instability, conditional (see Conditional instability)
 - thermal, defined, 17, 18, 50
 - and fire behavior, 49
 - and lapse rate, 17, 18, 50
 - local indicators of, 65—66
 - and turbulence, 89
 - and vertical motions, 17, 50, 51
- Instrument shelter, 20, 40
- Inversions of temperature, defined, 18
 - and fire behavior, 29—30
 - fog related to, 28

marine, 28
night (or nocturnal), 28—30, 115—116, 121
and stability, 18, 50
subsidence type, 27, 43, 61—62
surface, 28
turbulence effects on, 28, 57
types, 28
Isobaric analysis, 73
Isobars, 73
 geostrophic flow and, 75—76
 pressure gradient and, 75
 and winds, 75—77

J

Jet, low-level, 93, 94
Jet stream, 79—80
 and general circulation, 79—80
 polar front associated with, 79
 subtropical, 80
 temperature gradient in, 79—80

K

Kinetic energy, 4, 5

L

Lag of seasons, 15, 16
Lake breezes, 113
Laminar flow, 91
Land and sea breezes, 16, 109—113
 and fog, 112
Lapse rate of temperature, 17, 18
 and adiabatic rate of cooling, 17, 18
 autoconvective, 122
 average, 27
 conditionally unstable, 54—55
 dry-adiabatic, 17, 18, 50
 environment versus parcel, 17, 18, 50—55
 of layers, 55—56
 mixing effects on, 28, 57
 moist-adiabatic, 18, 50, 51, 53—55
 stability defined by, 17, 18, 50—56
 superadiabatic, 27, 50, 53
 turbulence affected by, 27, 28, 89
Latent heat, cyclonic energy released from, 74
 release, in ascent, 18, 53
 of vaporization, 18
Lee waves, 100
Level of free convection, 54
Lifting, by convection, 56, 69, 146—148
 by convergence, 57
 frontal, 56
 lapse rates affected by, 55—56
 orographic, 56, 148, 150
 thermal, 146—148
 by turbulence, 57

Light, character, 9
 speed, 9
Lightning, 175—177
 fires produced by, 4, 166, 168, 208, 209
Living fuel moisture, 182—485, 195
 seasonal changes, 182
 effect of vegetative type, 182—185
Local winds, (Chaps. 6 and 7) 85—126
Long wave, patterns, 78—79
 meridional, 78
 zonal, 78—79
 ridges, 78, 79
 troughs, 78, 79
Long waves in the westerlies, 78—79
Low clouds, 154, 159—161
Low-level jet, 93, 94
Low-pressure systems, 3, 16, 17, 57, 74
Lows, 74
 balance of forces, 76—77
 cut-off (or cold), 178
 defined, 74
 fronts and, 141—142
 gradient wind in, 76—77
 semipermanent, 80—83
 tracks of, 81—83
 waves on fronts and, 141—142
 wind in, 57, 74, 76—77, 78
Lulls, 88

M

Maritime air masses, 129
Maritime polar air masses, 131—132, 133—134
Maritime tropical air masses, 132, 134
Measurements, weather (see Weather observations)
Mechanical turbulence, 88—89
Mercurial barometer, 3, 72
Meridional pattern, 78
Mesosphere, 2
Middle clouds, 154, 157—158
Millibar, 3
Mixing, by convection, 9, 136
 lapse rate affected by, 57
 moisture distributed by, 45, 136
Moist-adiabatic lapse rate, 18, 50, 51, 53—55
Moist-adiabatic process, 18, 50, 51, 53—55
Moisture, atmospheric (see Atmospheric moisture)
Moisture content, of atmosphere, 3
 of fuels, (Chap. 11) 180—195
 dead, 185—194
 estimating, 192—194
 living, 182—185, 195
Moisture equilibrium in fuels, 187—188
Molecular activity, 4, 8
 and temperature, 4, 34
Momentum transport, by turbulence (or eddies), 89—90
Mono wind, 63, 102—103
Monsoon, 112
Mountain waves, 62, 64, 99—100, 102
Mountain winds (See Valley winds)
Mountains, effect of, on fronts, 142

on precipitation, 148, 150
on temperature, 29, 32
on wind, 62—64, 96—104, 112—114

N

Nimbostratus clouds, 158, 159
Nocturnal thunderstorms, 177
North Pacific Drift, 199
North winds, 102—103
Northeast trade winds, 71
Northwest Canadian High weather type, 216—218
Nucleation, artificial, 153

O

Observations, surface, 20, 21, 38—40, 86, 87, 165
 upper-air, 27, 65, 87
Occluded fronts (occlusions), 94, 95, 96, 141—143
Ocean currents, California, 199
 Gulf Stream, 199
 North Pacific Drift, 199
 temperatures affected by, 199
 upwelling, 133
Oceans, air masses affected by, 41—42, 131—132, 133—134
 effects on air temperatures, 31, 32, 199
 influence on climate, 199
 mixing of surface layers, 23
 temperatures, contrasted with continents, 80, 81
Orographic lifting, 56, 148, 150
Orographic thunderstorms, 177
Ozone, absorption of radiation by, 12

P

Pacific coast sea breeze, 112—113
Pacific coast monsoon, 112
Pacific High, 80, 81, 82
 weather type, 213, 219
Pacific ocean, 199
Parcel of air, in adiabatic process, 50—55
 buoyancy, 50—55
 environment related to, 50—55
 stability related to, 50—55
Parcel method, 50—55
Partial pressure, of water vapor, 35
Particles in atmosphere, 3, 22
Phase changes, 7
Pilot balloon observations (PIBALS), 87
Polar air masses, 129
Polar easterlies, 71
Polar front zone, 71, 72
 air masses and, 71
 jet stream and, 79
Polar outbreak, 72
Post-frontal offshore flow weather type, 204—205
Potential energy, 4, 5, Precipitation, measurement, 165

 patterns, 201—202
 processes, 152—154
 types, 163—165
Pressure, atmospheric, 3, 72
 cells, 72
 defined, 3
 distribution, 72—75
 measurement, 72—73
 partial, of water vapor, 35—36
 patterns, 72—75
 reduction, 73
 sea-level, 3
 standard, 3
 station, 73
 systems, 74—75
 semipermanent centers, 80—83
 thunderstorm effects on, 173, 174
 units, 3
 vertical variation, 3
 and volume relationship, 6
 and work, 7
Pressure gradient, defined, 75
 force exerted by, 75
 geostrophic flow and, 75—76
 gradient wind and, 76—78
 winds related to, 75—78
Prevailing westerlies, 71, 72
Psychrometer, 38
Psychrometric table, 38—40

R

Radar, weather, 177
Radiation, 8—11
 absorption, 9—14
 in atmosphere, 12
 air masses affected by, 129—130
 balance, 11—14
 black body, 10, 11
 carbon dioxide, 12
 cooling of atmosphere by, 26—27
 earth (see Earth radiation)
 emission (see Emission of radiation)
 energy transport and, 9, 10
 from snow surface, 23
 infrared, 9, 10, 12
 sky, 12
 solar (see Solar radiation)
 and temperature, 9, 10
 temperatures affected by, 11—16, 20—23, 26, 27, 28
 thermal, 9
 and transparency, 23
 ultraviolet, 9
 wavelength, 9, 10
Radiation fog, 161
Radiosonde, 87
Rain, 163
Rain gage, 165
Raindrops, formation, 153—154
Rainfall (see Precipitation)

Rainmaking, 153—154
 Rain shadow, 202
 Rawinsonde, 87
 Reduction of station pressure to sea level, 73
 Reflection, 11—14, 23, 24
 Relative humidity, 37—38
 variations in, 43—45
 effect of topography, wind, vegetation, and air masses, 45—48
 Ridges of high pressure, 75
 Rotation, coriolis force and, 70, 75
 latitude effect on vertical component, 75
 primary circulation modified by, 70—72

S

Santa Ana wind, 63, 83, 103—104
 Satellites, weather, (Cover)
 Saturation, adiabatic process at (see Adiabatic process)
 in clouds, 146
 defined, 36
 and dew-point temperature, 36—37
 layer stability affected by, 55—56
 processes, 146—151
 Sea breezes, 109 (see also Land and sea breezes)
 Sea-level chart, 73
 Sea-level pressure, 73
 Seasons, 14—16
 lag, 15, 16
 tropopause height related to, 2
 Seeding of clouds, 153—154
 Shear, wind, 92, 93, 94
 Short waves in the westerlies, 78—79
 Short-wave, ridges, 79
 troughs, 79
 Short-wave trough weather pattern, 208
 Silver iodide seeding, 153
 Sleet, 163
 Slope and valley winds, 113—119
 influence of general wind on, 119—122
 Slope winds, 114—116
 Smoke, temperatures affected by, 12, 22, 23
 Snow, 163
 formation, 153—154
 pellets, 163
 radiation from, 23
 reflection from, 23
 Solar radiation, 10—16
 reflection, 12
 and temperature, 11—16, 20—23, 26
 Soundings, temperature, plotted on diagrams, 51
 wind, 87
 Source regions of air masses, 129
 Southwesterly flow aloft weather pattern, 210—212
 Specific heat, 6, 24
 Spectrum, electromagnetic, 9
 and absorption, 10
 and emission, 10
 visible, 9, 10, 11
 Squall lines, 95—96, 139

Stability, 17, 18, (Chap. 4) 49—67
 determinations, 50—55
 and fire behavior, 49
 and lapse rate, 17, 18, 50—55
 of layers, 55—56
 local indicators of, 65—66
 neutral, 17—18, 50, 52—53
 thermal, defined, 17, 50
 and vertical motions, 25, 50, 51
 Standard atmospheric pressure, 3
 Standing waves, 100
 Statics of atmosphere, (Chaps. 1—4) 1—67
 Station pressure, 73
 Stationary fronts, 141
 Stratocumulus clouds, 159—160
 Stratosphere, defined, 2
 Stratus clouds, 159—160
 and fog, 159—161
 Sublimation, 8, 151
 heat of, 8
 Sublimation nuclei, 151—152
 Subsidence, 60—65
 and absolute humidity, 42—61
 defined, 16, 57
 and divergence, 57, 61
 and fire behavior, 49, 64
 lapse-rate changes, 56
 and relative humidity, 43, 61
 stability affected by, 56
 Subtropical High aloft weather pattern, 205, 207
 Sun, 11, 14
 earth and, 14, 15
 energy from, 4, 5, 11—16, 20—23
 Supercooling of liquid water, 152
 in clouds, 152, 153
 drops, 152
 Supersaturation, 152
 over ice particles, 153
 Surface characteristics and temperatures, 23—25
 Surface weather charts, 73
 Surface weather observations, 20, 21, 38—40, 86, 87, 165
 Synoptic charts, 73
 Synoptic observations, 73
 Synoptic weather types, by regions of the country, 204—214, 215—219

T

Temperature, (Chap. 2) 19—32
 adiabatic lapse rate, 17
 in adiabatic process, 17
 air, 25—30
 air-mass, 25—26
 conversion scales and formula, 20
 daily, lag of, 14
 defined, 4
 of dew point (see Dew-point temperature)
 discontinuity, 137
 distribution, vertical, 27—30
 effects of forests and vegetation, 30—31
 effects of surface properties, 23—25

expansion with, 6, 7
 and fire behavior, 19
 general circulation and, 16, 31
 gradient, 8
 internal energy and, 7
 inversions (see Inversions of temperature)
 in jet stream, 79—80
 lapse rate (see Lapse rate of temperature)
 measurement, 4, 20, 21
 molecular activity and, 4, 8, 34
 ocean effects on, 31, 32, 199
 pressure relationship, 6, 7, radiation effects on,
 11—16, 20—23, 26
 solar radiation and, 11—16, 20—23
 surface, 21—25
 and topography, 22, 29, 32
 and turbulence, 25, 26, 27
 variations, 27—32, 200—201
 volume relationship, 6
 wet-bulb, 38, 39
 wind effects on, 25, 26, 27, 28
 Theory of general circulation, 16
 Thermal belt, 29, 32
 Thermal conductivity, 8, 9
 Thermal instability (see Instability)
 Thermal lifting, 146—148, 149
 Thermal turbulence, 89—90
 Thermometers, 6, 20
 radiation effects on, 20
 shelters, 20, 21
 ventilation, 20, 21
 Thermosphere, 2
 Thunder, 177
 Thunderstorms, (Chap. 10) 166-1 79
 cells, 167
 clusters of, 171, 174—175
 development of new, 174—175
 stages, 171—174
 classification, 177
 defined, 167
 development, 167—171
 conditions necessary for, 167—169
 thermodynamics of, 169—171
 downdrafts in, 16, 124—125, 167, 173—175,
 177—178
 dry or high-level, 177—178, 208, 209
 electricity, 175—177
 energy diagrams, 169—171
 entrainment in, 171
 gusts in, 173—174
 hail in, 164—165
 life cycle, 171—175
 night or nocturnal, 177
 pressure changes with, 173
 tornadoes related to, 178—179
 turbulence, 173—174
 winds, 124—125, 172—174
 Timelag period, 188—189
 Timelag principle, 188—189
 Tornadoes, 83—84, 178—179
 winds in, 83, 179
 Trade winds, 72
 Transpiration, 40, 41

Tropical air masses, 129
 Tropical storms, 72
 Tropopause, defined, 2
 height, 2
 seasonal changes, 2
 Troposphere, defined, 2
 air in, composition, 3
 Troughs of low pressure, 74
 and fronts, 94, 137
 Turbulence, 57, 88—91
 and fire behavior, 91
 and friction, 88—89
 mechanical, 88—89
 temperatures affected by, 25, 26, 27
 thermal, 89—90
 in thunderstorms, 173—174
 Types of air masses, 129—130
 Types of clouds, 100, 154—163
 Types of fronts, 94, 137
 Types of precipitation, 163—165
 Types of thunderstorms, 177—178

U

Ultraviolet radiation, 9
 Updrafts, 16, 124, 171—175
 Upper-air charts, 73—74
 Upper-air observations, 27, 65, 87
 Upper cold fronts, 142, 143
 Upslope fog, 151, 161
 Upwelling ocean currents, 133

V

Valley winds, 116—118
 Valley and slope winds, 113—119
 effect of general wind on, 119—122
 effect of orientation and vegetation on, 118—119
 Vapor pressure, defined, 35
 related to fuel moisture, 185—188
 saturation, 36
 over cloud droplets, 153
 over ice, 36, 153
 table, 36
 over water, 35
 Vegetation, effects on
 humidity, 46—48
 temperature, 30—31
 winds, 104—105, 118—119
 by regions, 202—220
 Vertical cross sections of fronts, 138, 139, 140, 143
 Vertical motion, 16, 17, 18
 adiabatic changes in, 17, 18, 50
 and condensation 18, 53—55, 146—151
 and divergence, 57
 expansion in, 17, 50
 and stability, 17, 50, 51, 55—56
 temperature changes in, 17, 18, 50—56

in thunderstorms, 167, 171—175
Virga, 158
Visibility, air mass, 135
in troposphere, 3

W

Warm fronts, 94, 95, 139—141
Warming by compression, 6, 7, 17
Water phases in atmosphere, 7, 34
Water vapor, 7, 8, 34—38
absorption of radiation by, 12, 23, 26
capacity in air, 36—37
condensation, 8, 36, 151—152
heat carried by, 8
in atmosphere, 3
radiation from, 26
sources of, 40—41
transport, 145
Waterspouts, 83—84
Wavelength, of radiation, 9—14
of upper waves 78—79
Waves, in the easterlies, 83
frontal, 141
mountain (see Mountain waves)
in the westerlies, 78
Weather charts, 73
Weather and fuel moisture, (Chap. 11) 180—195
Weather observations, 20, 21, 38—40, 72—73, 86, 87,
165
Weather satellites (Cover)
Weather types, by regions of the country, 204—214,
215—219
Weight of the atmosphere, 3
Westerlies, circumpolar, 78—80
jet stream and, 79—80
waves in, 78—79
Wet-bulb temperature, defined, 38
Whirlwinds, 108—109, 122—124
Wind, aloft, 91—93
convective, (Chap. 7) 107—126
diurnal variation, 90

downslope afternoon, 121—122
effects of mountains on, 62—64, 96—
104
effects of vegetation on, 104—105
fall, 100
and fire behavior, 85, 91, 107, 120
friction effects, 77—78
foehn, 62—63, 100—104
frontal, 93—96, 138, 139
general, (Chap. 6) 85—106
effect on land and sea breezes, 110—
111
effect on slope and valley winds,
119—122
geostrophic, 75—76
gradient, 76—78
gusts, 27, 88, 89, 91, 113, 125, 173
in High, 57, 75, 86
in jet stream, 79—80
local, (Chaps. 7 and 8) 85—126
in Low, 57, 74, 76
lulls, 88
measurement, at surface, 86
in upper air, 87
pressure gradient related to, 75—78
profiles, 92—93, 94, 104
shear, 92, 93, 94
slope and valley, 113—119
squalls, 95—96, 125—139
surface, 92
thunderstorms, 124—125, 172—174
turbulence, 25, 59, 88—91
vane, 86
Work, in gases, 7

Z

Zonal pattern, 78—79